

KOMATSU

PW
148



Hydraulic Wheeled Excavator

PW148-10

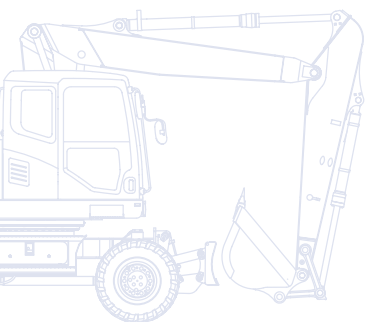

ENGINE POWER
90,0 kW / 121 HP @ 2.100 rpm

OPERATING WEIGHT
14.435 - 16.250 kg

BUCKET CAPACITY
max. 0,86 m³

Walk-Around

The experts at Komatsu designed the PW148-10 with a drastically reduced tail swing to meet the demands of safe and productive work on all jobsites with limited space. Compact, powerful and versatile, this hydraulic wheeled excavator is the perfect machine in urbanised areas or for road construction. Performance and quality: that's what you expect from Komatsu equipment, and the PW148-10 delivers.

Total versatility

- Compact design
- Additional hydraulic circuit
- Easily customised

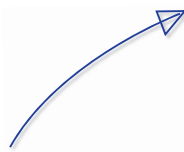

Powerful and environmentally friendly

- Low consumption EU Stage IIIB engine
- Excellent travel performance
- High lift capacity
- Fuel-saving engine and hydraulic technology
- Adjustable Eco-gauge and idle caution



PW148-10

ENGINE POWER
90,0 kW / 121 HP @ 2.100 rpm

OPERATING WEIGHT
14.435 - 16.250 kg

BUCKET CAPACITY
max. 0,86 m³

First-class operator comfort

- Wide spacious cab
- Air-suspended, heated seat
- Automatic climate control
- Improved operator convenience
- High resolution widescreen monitor



State-of-the-art controls

- Proportional controls for attachments
- Easy operation
- Selectable working modes
- Flexible and versatile

Easy Maintenance

- Simple and convenient service
- Easy radiator access
- Centralised greasing system
- Large TFT monitor
- Electric refuelling pump



KOMTRAX

Komatsu Wireless
Monitoring System

**KOMATSU
CARE**

A maintenance program
for Komatsu customers

Total Versatility

Compact design

The PW148-10 is perfect for confined work sites, with a compact design and a tail swing radius of only 1,85 m. In urbanised areas, but also on road or sewer construction sites where space is limited, the PW148-10 is a high output performer and offers more safety and less worries for the operator.

Additional hydraulic circuit

To allow the use of many attachments, such as buckets, breakers or clamshell buckets, an additional hydraulic circuit controlled by a sliding joystick button is standard on the PW148-10. To further increase versatility and flexibility, a second optional auxiliary line and an optional hydraulic quick-coupler actuation are also available.

Easily customised

With a choice of different styles of boom, arm and undercarriage attachments, you can configure the PW148-10 to match specific demands for transport, working envelope or duty. The excavator can be equipped with a parallel-moving dozer blade that stabilizes the machine without damaging the street surface. Extra hydraulic arrangements for every boom and arm make the PW148-10 a strong contributor to your business.





First-Class Operator Comfort

Newly designed SpaceCab™

The all-new cab provides an ergonomic and quiet work environment, with an outstanding view of the jobsite. ROPS certified, it was specifically designed by Komatsu for hydraulic excavators, with a reinforced pipe-structured framework set up on viscous damper mounts for low vibration levels. Unique features include switches that light up for safe and easy night operation, and a standard telescopic steering wheel, comfortably adjustable in height and reach.

Air-suspended, heated seat

The high comfort air-suspended seat, with a heating function, lumbar support and multiple possibilities for adjustments, ensures the operator's well being during the entire working day. The seat and the side consoles can be adjusted individually to fit each operator's preference.



Newly designed SpaceCab™

Improved operator convenience

With increased in-cab storage space, an auxiliary input (MP3 jack) and 12 V and 24 V power supply, the cab offers maximum convenience. The automatic air conditioner allows the operator to easily and precisely set the cab's atmosphere.



Auxiliary input (MP3 jack)

High resolution widescreen monitor

To enable safe, accurate and smooth work, the user-friendly monitor is the highly intuitive user interface for the machine's Equipment Management and Monitoring System (EMMS). Multilingual and with all essential information available at a glance, it features simple and easy-to-operate switches and multifunction keys that provide the operator with fingertip access to a wide range of functions and operating information.





State-of-the-Art Controls

Proportional controls

The ergonomic joysticks with proportional controls were specially redesigned and developed for working with a wheeled excavator. They have horizontal sliders for the first and second (optional) attachment lines and offer safe and precise operation of attachments such as ditch cleaning buckets, sorting grapples, clamshell buckets, tilt rotators and of many other hydraulic attachments that require very fine control.

Easy operation

The Komatsu PW148-10 introduces a new operational concept that puts full control of the machine right at the operator's fingertips. A rear-view camera, undercarriage attachments and the manual axle lock can all be actuated by buttons on top of the operational levers. Without removing the hand from the right joystick, the operator can switch its function from boom operation to undercarriage control for complete and precise control over the parallel dozer blade.

6 working modes

Power, Lifting, Breaker, Economy, Attachment Power and Attachment Economy modes are all available, ensuring that the PW148-10 delivers the required power you need with minimal fuel consumption. The Economy mode can be adjusted for an ideal balance between power and economy to match the work at hand. The oil flow delivered to hydraulic attachments is adjustable directly on the class-leading wide-screen monitor panel.

Flexible and versatile

The PW148-10 is factory prepared for the use of any standard tilt rotator. In combination with the optional hydraulic quick-coupler actuation, it achieves a maximum of versatility in any application.



6 working modes available



Easy undercarriage control



Ergonomically designed switches





Powerful and Environmentally Friendly

New Komatsu engine technology

The powerful and fuel-efficient Komatsu SAA4D107E-2 engine in the PW148-10 delivers 90,0 kW / 121 HP and is EU Stage IIIB certified. To maximise power, fuel efficiency and emission compliance, it is turbo charged and features direct fuel injection, air-to-air after cooling and cooled EGR.

Komatsu integrated hydraulic system

The PW148-10 is a highly responsive and productive machine with all major hydraulic parts designed and manufactured by Komatsu. The electronic Closed-centre Load Sensing hydraulic System (CLSS) offers complete control during individual or combined movements - without sacrificing performance or productivity.



Komatsu Diesel Oxidation Catalyst (KDOC)

A simple and high efficiency diesel oxidation catalyst that eliminates the need for PM regeneration and simplifies the engine control system. It integrates a high performance exhaust noise silencer and helps to reduce engine noise.

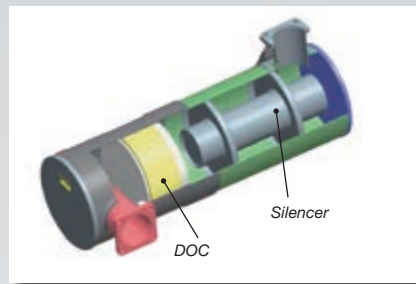

Exhaust Gas Recirculation (EGR)

Cooled EGR is a technology well-proven in current Komatsu engines. The increased capacity of the EGR cooler now ensures very low NOx emissions and a better engine performance.

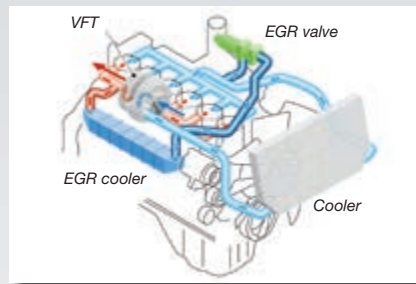

Variable Flow Turbocharger (VFT)

Varies the intake airflow. The wheel speed of the exhaust turbine is controlled by a valve for optimum airflow to the engine combustion chamber, under any load or speed conditions. The exhaust gas is cleaner, with no reduction in power or performance.

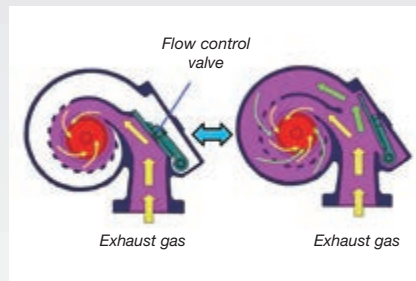

Komatsu Closed Crankcase Ventilation (KCCV)

Crankcase emissions (blow-by gas) are passed through a CCV filter. The oil mist trapped in the filter is returned back to the crankcase while the filtered gas is returned to the air intake.

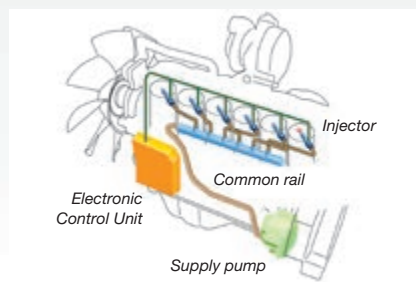

High-Pressure Common Rail (HPCR)

To achieve complete fuel burn and lower exhaust emissions, the heavy-duty High-Pressure Common Rail fuel injection system is computer controlled to deliver a precise quantity of pressurised fuel into the redesigned engine combustion chamber by multiple injections.

High lift capacity

Along with its class-leading compact size, the PW148-10 features an unrivalled lifting performance. The combination of power, convenient dimensions and complete control makes the PW148-10 the first choice for heavy-duty lifting applications or simple excavating tasks in narrow alleys and on road building and sewer construction sites.



Excellent travel performance

Wheeled excavators are built to move quickly on and between jobsites. To increase its mobility, the PW148-10 features a completely reworked driveline for faster travel and uphill driving speeds. For extra comfort, cruise control and a driveline power-up function are also standard equipment.

Adjustable Eco-gauge and idle caution

The new Eco-gauge can be set to target a fuel consumption value, encouraging the operator to work as efficiently as possible. And to further avoid wasting fuel when the machine is not actually working, a standard-fit idle caution is displayed if the engine idles for 5 minutes or more.



Active Eco recommendations

Easy Maintenance



Centralised greasing system

The PW148-10 features a centralised system that facilitates the regular greasing of the complete revolving frame, boom system and of the centre joint. An optional fully automatic greasing system can handle the regular and proper greasing of the complete machine – prolonging the lifetime and increasing the resale value of the excavator.



Komatsu CARE™

Komatsu CARE™ is a maintenance program that comes as standard with your new Komatsu machine. It covers factory-scheduled maintenance, performed with Komatsu Genuine parts by Komatsu-trained technicians. Depending on your machine's engine, it also offers extended coverage of the Komatsu Diesel Particulate Filter (KDPF) or the Komatsu Diesel Oxidation Catalyst (KDOC), and of the Selective Catalytic Reduction (SCR). Please contact your local Komatsu distributor for terms and conditions.



Electric refuelling pump

Standard equipment on all PW148-10 includes an automatic shut-off fuelling pump that allows easy refuelling from a barrel.

Easy radiator access

Thanks to a side-by-side cooler arrangement, the aftercooler and hydraulic oil radiator can be cleaned easily and repaired individually in case of damage.

Simple and convenient service

The large doors and engine hood give convenient access to all daily service points. Filters are centralised and required service intervals are longer to keep machine downtime to a minimum.





Komatsu Wireless Monitoring System

The way to higher productivity

KOMTRAX™ uses the latest wireless monitoring technology. Compatible on PC, smartphone or tablet, it delivers insightful and cost saving information about your fleet and equipment, and offers a wealth of information to facilitate peak machine performance. By creating a tightly integrated web of support it allows proactive and preventive maintenance and helps to efficiently run a business.

Power

The detailed information that KOMTRAX™ puts at your fingertips 24 hours a day, 7 days a week gives the power to make better daily and long-term strategic decisions – at no extra cost. Problems can be anticipated, maintenance schedules customised, downtime minimised and machines kept where they belong: working on the jobsite.

Knowledge

You get quick answers to basic and critical questions about your machines - what they're doing, when they did it, where they're located, how they can be used more efficiently, and when they need to be serviced. Performance data is relayed by wireless communication technology (Satellite, GPRS or 3G depending on model) from the machine to a computer and to the local Komatsu distributor - who's readily available for expert analysis and feedback.

Convenience

KOMTRAX™ enables convenient fleet management on the web, wherever you are. Data is analysed and packaged specifically for effortless and intuitive viewing in maps, lists, graphs and charts. You can foresee eventual maintenance issues and required spare parts, and troubleshoot a problem before Komatsu technicians arrive on site.

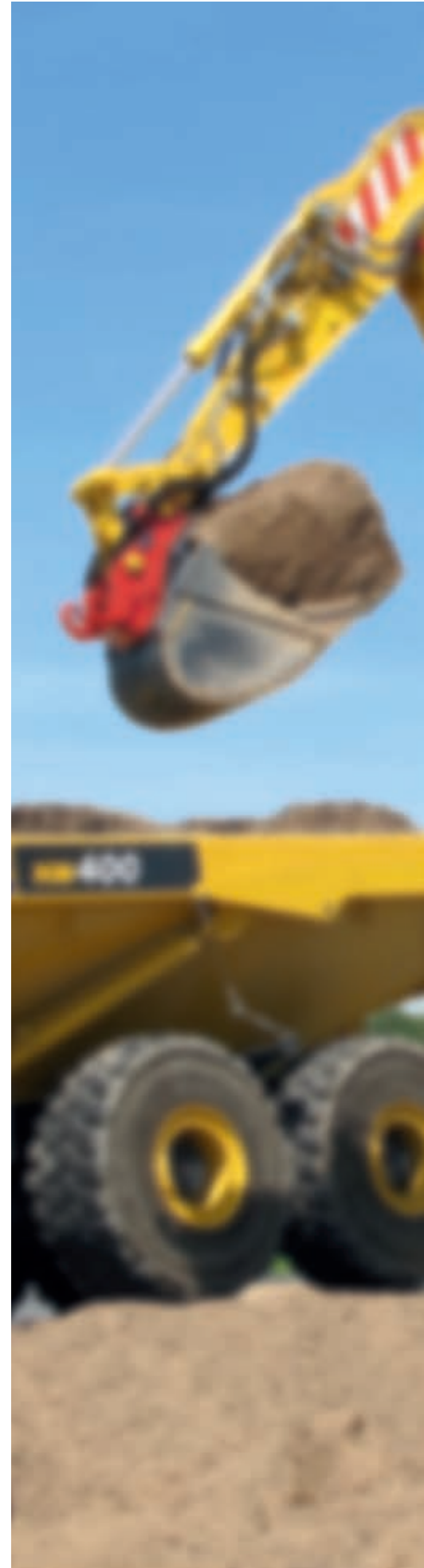



Highest Safety Standards

Short tail swing radius

Measuring only 1,85 m, the tail of the PW148-10 is more compact than on conventional models, with less need for the operator to worry about movement from the rear of the machine.

Safe SpaceCab™

Specifically designed for Komatsu excavators, the SpaceCab™ has a tubular steel frame. It provides very high shock absorbency, impact resistance and durability. The seat belt keeps the operator in the safety zone of the cab in the event of a roll-over. On request, the Komatsu PW148-10 can also be fitted with an ISO 10262 Level 2 Falling Object Protective System (FOPS).

Safe operation in confined areas

The compact tail design minimises the risks of rear impact and lets the operator concentrate fully on the job. The machine can work safely in narrow spaces or in obstructed areas.

Rear-view camera

A standard fitted camera gives an exceptionally clear view of the rear work zone on the widescreen monitor panel. The low profile camera is adjustable and integrated into the counterweight's shape. On request, another camera can be added to the right side of the machine.

Safe and easy maintenance

Thermal guards are placed around high temperature parts of the engine. The fan belt and pulleys are well protected and in case of damage, fire risk is reduced by a pump/engine partition that prevents hydraulic oil from spraying onto the engine. The engine hood is hinged to the rear, with anti-slip plates positioned around the engine bay to ensure safe and easy access from all sides. Exceptionally sturdy handrails further contribute to a high safety level.





Specifications

ENGINE

Model	Komatsu SAA4D107E-2
Type	Common rail direct injection, water-cooled, emissionised, turbocharged, after-cooled diesel
Engine power	
at rated engine speed	2.100 rpm
ISO 14396	90,0 kW/121 HP
ISO 9249 (net engine power)	86,0 kW/115 HP
No. of cylinders	4
Bore × stroke	107 × 124 mm
Displacement	4,5 l
Batteries	2 × 12 V/120 Ah
Alternator	24 V/60 A
Starter motor	24 V/4,5 kW
Air filter type	Double element type with monitor panel dust indicator and auto dust evacuator
Cooling	Suction type cooling fan

HYDRAULIC SYSTEM

Type	HydraMind. Closed-centre system with load sensing and pressure compensation valves
Additional circuits	Depending on the specification up to 2 additional proportional control & quick coupler circuits can be installed
Main pump	Variable displacement piston pump supplying boom, arm, bucket, swing and travel circuits
Maximum pump flow	252 l/min
Relief valve settings	
Implement	380 bar
Travel	380 bar
Swing	280 bar
Pilot circuit	37 bar

BRAKE SYSTEM

Type	Dual circuit hydraulic braking system supplied from a separate gear pump
Service brakes	Pedal actuated wet multi-disc brakes integrated into the axle hubs
Parking brake	Electrically actuated wet multi-disc “spring actuation hydraulic release” brake integrated into the transmission

ENVIRONMENT

Engine emissions	Fully complies with EU Stage IIIB exhaust emission regulations
Noise levels	
LwA external	101 dB(A) (2000/14/EC Stage II)
LpA operator ear	69 dB(A) (ISO 6396 dynamic test)
Vibration levels (EN 12096:1997)	
Hand/arm	≤ 2,5 m/s ² (uncertainty K = 0,34 m/s ²)
Body	≤ 0,5 m/s ² (uncertainty K = 0,16 m/s ²)
Contains fluorinated greenhouse gas HFC-134a (GWP 1430).	
Quantity of gas 0,9 kg, CO ₂ equivalent 1,29 t.	

SWING SYSTEM

Type	Axial piston motor driving through planetary double reduction gearbox
Swing lock	Electrically actuated wet multi-disc brake integrated into swing motor
Swing speed	0 - 11 rpm
Swing torque	31 kNm

TRANSMISSION

Type	Fully automatic power shift transmission with permanent 4 wheel drive
Travel motors	One variable displacement axial piston motor
Maximum pressure	380 bar
Travel modes	Automatic + 3 travel modes
Max. travel speeds	
Hi / Lo / Creep	35,0 / 9,0 / 2,5 km/h
A max. speed restriction of 20 km/h is available as an option	
Maximum drawbar pull	8.900 kg
Axle oscillation	10° Lockable in any position from the operator cab

STEERING SYSTEM

Steering control	Hydraulic steering system supplied from a separate gear pump and controlled through LS orbitrol & priority valves
Minimum turning radius	6.450 mm (to center of outer wheel)

SERVICE REFILL CAPACITIES

Fuel tank	252 l
Radiator	22 l
Engine oil	18 l
Swing drive	2,5 l
Hydraulic tank	169 l
Transmission	4,85 l
Front differential	10,5 l
Rear differential	9,5 l
Front axle hub	2,5 l
Rear axle hub	2,0 l
Swing pinion grease bath amount	10,5 l

OPERATING WEIGHT (APPR.)

Undercarriage attachment type	Mono boom	Two-piece boom
Without	13.730 kg	13.950 kg
Rear blade	14.435 kg	14.670 kg
Rear outrigger	14.880 kg	15.095 kg
2 outriggers + blade	15.585 kg	15.810 kg
4 outriggers	16.030 kg	16.250 kg

Operating weight, including specified work equipment, 2.500 mm arm, operator, lubricant, coolant, full fuel tank, quick-coupler (170 kg), bucket (500 kg) and the standard equipment.

MAX. BUCKET CAPACITY AND WEIGHT

Arm length	Mono boom		
	2,1 m	2,5 m	3,0 m
Material weight up to 1,2 t/m ³	0,86 m ³ 600 kg	0,80 m ³ 550 kg	0,68 m ³ 500 kg
Material weight up to 1,5 t/m ³	0,73 m ³ 525 kg	0,68 m ³ 500 kg	0,58 m ³ 450 kg
Material weight up to 1,8 t/m ³	0,63 m ³ 475 kg	0,50 m ³ 450 kg	0,50 m ³ 425 kg
Arm length	Two-piece boom		
	2,1 m	2,5 m	3,0 m
Material weight up to 1,2 t/m ³	0,77 m ³ 550 kg	0,71 m ³ 525 kg	0,62 m ³ 475 kg
Material weight up to 1,5 t/m ³	0,65 m ³ 500 kg	0,60 m ³ 475 kg	0,53 m ³ 425 kg
Material weight up to 1,8 t/m ³	0,57 m ³ 450 kg	0,52 m ³ 425 kg	0,45 m ³ 400 kg

Max. capacity and weight have been calculated according to ISO 10567:2007.

Please consult with your distributor for the correct selection of buckets and attachments to suit the application.

BUCKET AND ARM FORCE

Arm length	2,1 m	2,5 m	3,0 m
Bucket digging force	86 kN	86 kN	86 kN
Bucket digging force at PowerMax	93 kN	93 kN	93 kN
Arm crowd force	74 kN	62 kN	52 kN
Arm crowd force at PowerMax	80 kN	67 kN	56 kN

Dimensions

MONO BOOM

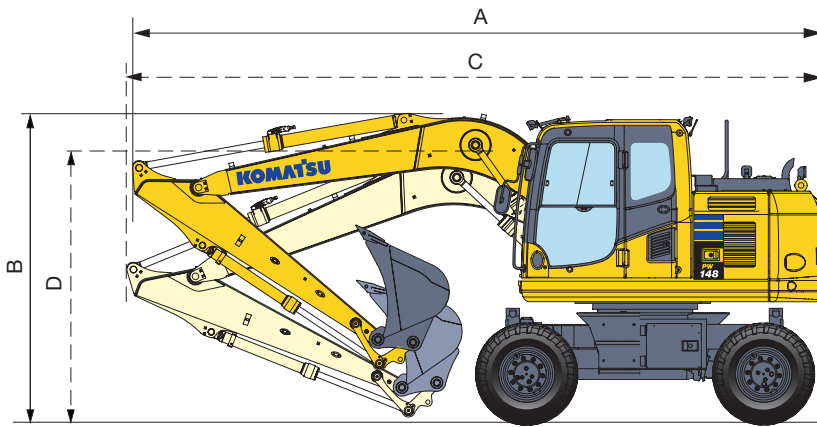

Driving position

Arm length	A	B
2.100 mm	7.120 mm	3.680 mm
2.500 mm	7.120 mm	3.680 mm
3.000 mm *	7.160 mm	3.680 mm

Transport position

Arm length	C	D
2.100 mm	7.370 mm	2.850 mm
2.500 mm	7.375 mm	2.945 mm
3.000 mm	7.395 mm	3.225 mm

* Driving position without bucket

TWO-PIECE BOOM

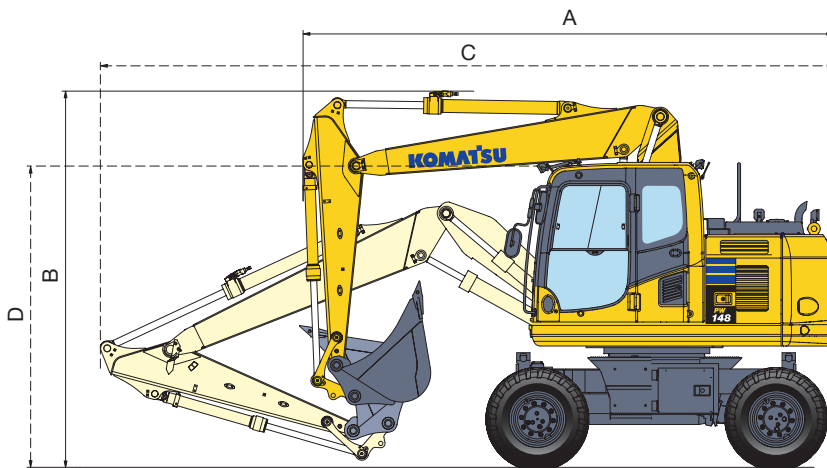

Driving position

Arm length	A	B
2.100 mm	5.545 mm	3.910 mm
2.500 mm	5.545 mm	3.910 mm
3.000 mm *	5.545 mm	3.910 mm

Transport position

Arm length	C	D
2.100 mm	7.690 mm	3.155 mm
2.500 mm	7.690 mm	3.155 mm
3.000 mm	7.690 mm	3.155 mm

* Driving position without bucket

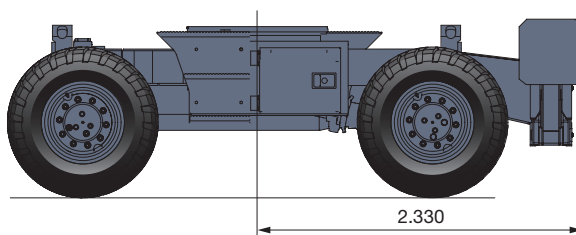
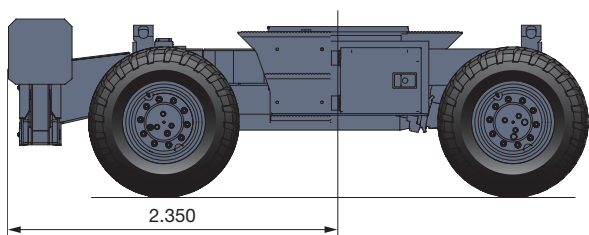
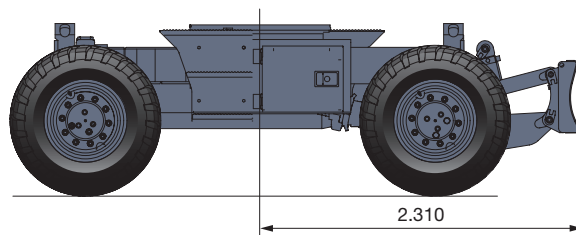
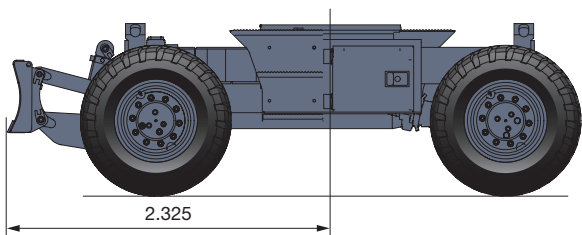
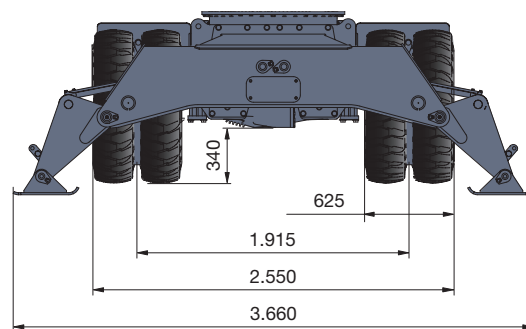
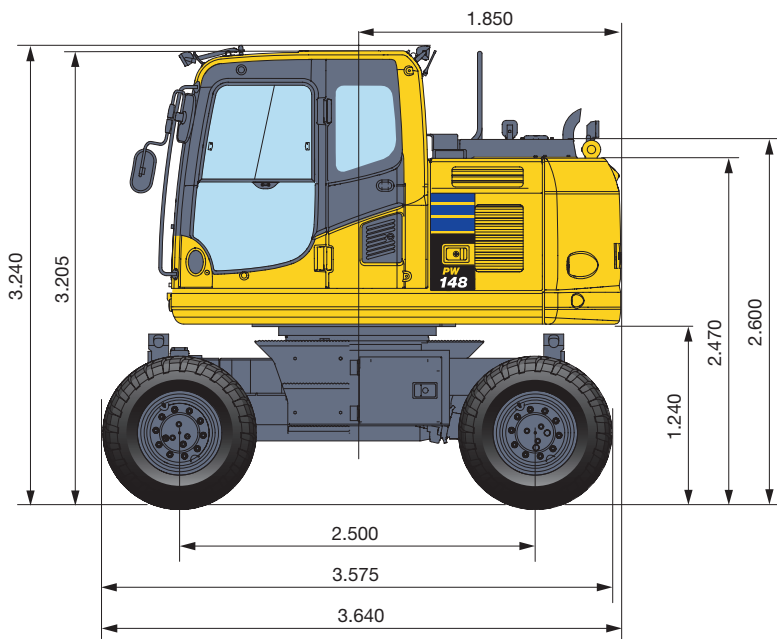

Working Range

MONO BOOM

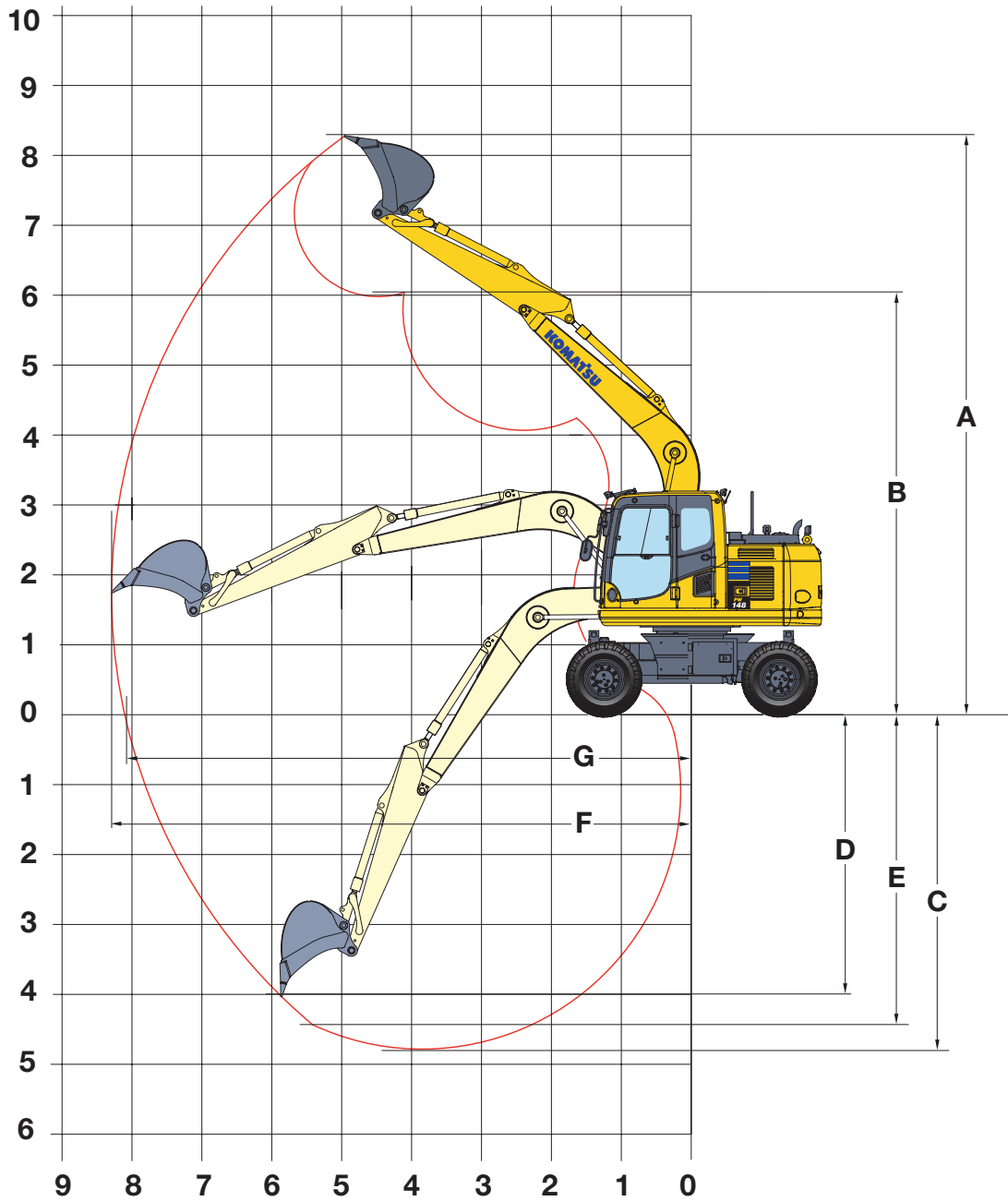

ARM LENGTH	2.100 mm	2.500 mm	3.000 mm
A Max. digging height	7.980 mm	8.270 mm	8.703 mm
B Max. dumping height	5.731 mm	6.020 mm	6.449 mm
C Max. digging depth	4.462 mm	4.860 mm	5.362 mm
D Max. vertical wall digging depth	3.630 mm	4.005 mm	4.470 mm
E Max. digging depth of cut for 2,44 m level	4.025 mm	4.570 mm	4.955 mm
F Max. digging reach	7.928 mm	8.290 mm	8.775 mm
G Max. digging reach at ground level	7.740 mm	8.140 mm	8.640 mm
Min. swing radius	2.965 mm	2.910 mm	2.925 mm

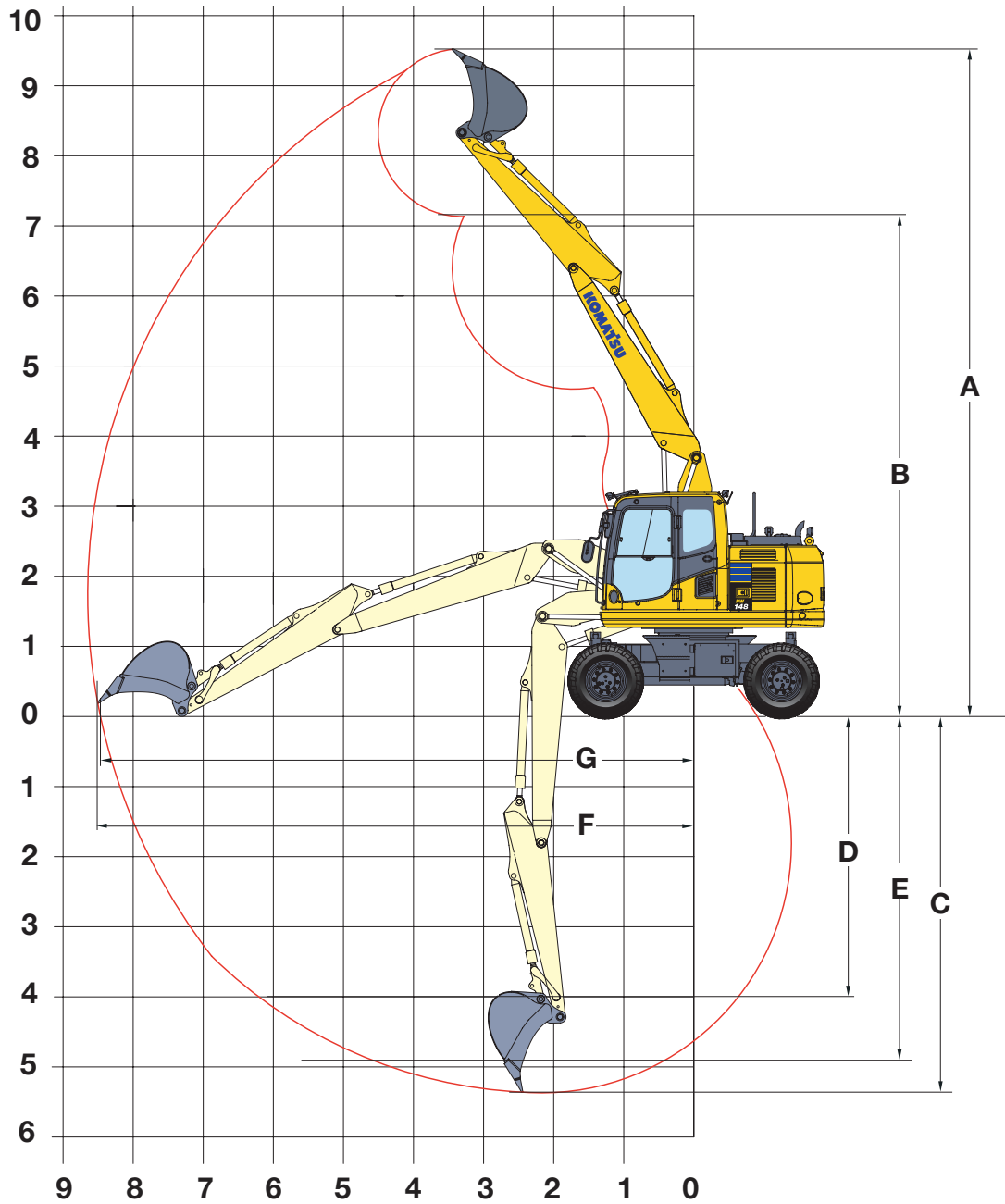

TWO-PIECE BOOM



ARM LENGTH	2.100 mm	2.500 mm	3.000 mm
A Max. digging height	9.228 mm	9.518 mm	9.951 mm
B Max. dumping height	6.844 mm	7.133 mm	7.562 mm
C Max. digging depth	4.845 mm	5.245 mm	5.745 mm
D Max. vertical wall digging depth	3.555 mm	4.000 mm	4.495 mm
E Max. digging depth of cut for 2,44 m level	4.515 mm	4.935 mm	5.460 mm
F Max. digging reach	8.268 mm	8.681 mm	9.000 mm
G Max. digging reach at ground level	7.740 mm	8.140 mm	8.640 mm
Min. swing radius	2.590 mm	2.670 mm	2.864 mm

Lifting Capacity

MONO BOOM

Arm length	A	7,5 m		6,0 m		4,5 m		3,0 m		1,5 m				
 Without stabilizer	2,1 m	7,5 m	kg											
		6,0 m	kg	*2.850	2.400									
		4,5 m	kg	2.500	1.850	2.800	2.100	4.500	3.300					
		3,0 m	kg	2.150	1.650	2.800	2.000	4.350	3.000	8.300	5.700			
		1,5 m	kg	2.100	1.500	2.700	1.950	4.050	2.950					
		0,0 m	kg	2.150	1.600	2.600	1.900	3.750	2.800	7.350	4.900			
	2,5 m	-1,5 m	kg	2.450	1.750	2.550	1.800	3.900	2.700	7.350	4.900	*6.350 *6.350		
		-3,0 m	kg	3.300	2.250			3.900	2.700	*6.550	5.000			
		7,5 m	kg											
		6,0 m	kg	*2.350	2.150	*2.550	2.150							
		4,5 m	kg	*2.250	1.700	2.850	2.100							
		3,0 m	kg	2.100	1.500	2.750	2.100	4.350	3.200	*8.050	5.900			
	3,0 m	1,5 m	kg	1.950	1.400	2.550	1.950	4.100	3.000	7.800	5.200			
		0,0 m	kg	2.000	1.450	2.600	1.850	3.850	2.700	7.350	4.800			
		-1,5 m	kg	2.200	1.600	2.550	1.850	3.850	2.700	7.350	4.850	*5.750 *5.750		
		-3,0 m	kg	2.700	2.000			3.900	2.750	7.400	4.950			
		7,5 m	kg	*2.300	*2.300									
		6,0 m	kg	*2.000	1.800	2.900	2.150							
 Front or rear blade	2,1 m	4,5 m	kg	2.600	2.150	3.000	2.450	5.050	3.900					
		3,0 m	kg	2.550	1.950	2.850	2.400	4.800	3.650	*8.850	6.750			
		1,5 m	kg	2.400	1.800	3.050	2.300	4.600	3.450					
		0,0 m	kg	2.250	1.850	2.700	2.250	4.050	3.300	*7.700	5.850			
		-1,5 m	kg	2.650	2.100	2.950	2.250	4.350	3.250	8.300	5.850	*6.350 *6.350		
		-3,0 m	kg	3.300	2.750			4.450	3.300	*6.550	6.000			
	2,5 m	7,5 m	kg											
		6,0 m	kg	*2.350	*2.400	*2.550	2.500							
		4,5 m	kg	*2.250	2.000	3.050	2.500							
		3,0 m	kg	*2.250	1.800	3.000	2.400	4.900	3.750	*8.050	6.900			
		1,5 m	kg	2.250	1.700	3.000	2.300	4.650	3.450	8.700	6.200			
		0,0 m	kg	2.050	1.750	3.000	2.250	4.450	3.300	*8.150	5.900			
	3,0 m	-1,5 m	kg	2.550	1.950	2.550	2.200	4.350	3.250	8.300	5.850	*5.750 *5.750		
		-3,0 m	kg	3.200	2.400			4.400	3.250	*7.550	5.900			
		7,5 m	kg	*2.300	*2.300									
		6,0 m	kg	*2.000	*2.000	3.300	2.550							
		4,5 m	kg	*1.850	1.750	3.250	2.500							
		3,0 m	kg	*1.850	1.550	2.050	1.650	3.150	2.400	4.900	3.750			
 Rear outrigger	2,1 m	1,5 m	kg	*1.950	1.500	1.950	1.650	3.000	2.250	4.600	3.450	8.750	6.300	
		0,0 m	kg	1.850	1.500	1.950	1.550	2.900	2.150	4.350	3.200	8.250	5.800	
		-1,5 m	kg	2.150	1.650	2.550	2.100	3.950	3.100	8.100	5.650	*5.000	*5.000	
		-3,0 m	kg	2.550	2.000	2.850	2.100	4.250	3.100	8.150	5.700	*8.050	*8.050	
		7,5 m	kg											
		6,0 m	kg	*2.850	*2.850									
	2,5 m	4,5 m	kg	*2.700	*2.650	3.450	3.150	*5.150	4.900					
		3,0 m	kg	*2.700	2.450	3.400	3.050	5.200	4.700	*8.850	*8.850			
		1,5 m	kg	2.500	2.350	3.200	3.000	4.700	4.450					
		0,0 m	kg	2.550	2.400	3.100	2.900	4.800	4.300	*7.700	*7.700			
		-1,5 m	kg	2.900	2.700	2.950	2.850	4.750	4.250	9.000	8.000	*6.350	*6.350	
		-3,0 m	kg	*3.500	*3.500			*4.600	4.300	*6.550	*6.550			
	3,0 m	7,5 m	kg											
		6,0 m	kg	*2.350	*2.350	*2.550	*2.550							
		4,5 m	kg	*2.250	*2.250	3.500	3.150							
		3,0 m	kg	*2.250	2.250	3.450	3.100	5.050	4.750	*8.050	*8.050			
		1,5 m	kg	*2.350	2.200	3.250	3.000	5.000	4.500	9.350	8.400			
		0,0 m	kg	2.500	2.250	3.100	2.900	4.800	4.350	*8.150	8.000			
3,0 m	-1,5 m	kg	2.750	2.500	3.150	2.850	4.450	4.250	8.900	8.000	*5.750	*5.750		
	-3,0 m	kg	3.450	3.150			4.750	4.250	*7.550	*7.550				
	7,5 m	kg	*2.300	*2.300										
	6,0 m	kg	*2.000	*2.000	*3.300	3.200								
	4,5 m	kg	*1.850	*1.850	3.300	3.150								
	3,0 m	kg	*1.850	*1.850	2.150	2.150	3.400	3.050	4.950	4.800				
3,0 m	1,5 m	kg	*1.950	1.950	2.350	2.100	3.250	2.950	4.650	4.500	9.450	8.450		
	0,0 m	kg	2.100	1.950	2.100	2.050	3.150	2.850	4.750	4.250	*8.600	7.950		
	-1,5 m	kg	2.250	2.150			2.850	2.750	4.600	4.100	8.750	7.800	*5.000	*5.000
	-3,0 m	kg	2.900	2.600	2.850	2.750	4.600	4.100	*8.400	7.850	*8.050	*8.050		

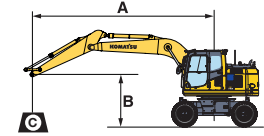













- A – Reach from swing center
- B – Bucket hook height
- C – Lifting capacities, including bucket linkage (84 kg) and bucket cylinder (96 kg)

- Rating over front
- Rating over side
- Rating at maximum reach

When removing linkage or cylinder, lifting capacities can be increased by their respective weights.

* Load is limited by hydraulic capacity rather than tipping. Ratings are based on SAE Standard No. J1097. Rated loads do not exceed 87% of hydraulic lift capacity or 75% of tipping load.

MONO BOOM

Arm length	A	7,5 m		6,0 m		4,5 m		3,0 m		1,5 m		
												
 Outrigger + blade	2,1 m	7,5 m kg										
		6,0 m kg	*2.850	*2.850								
		4,5 m kg	*2.700	*2.700	*4.050	3.950	*5.150	*5.150				
		3,0 m kg	*2.700	*2.700	*4.850	3.900	*6.050	*6.000	*8.850	*8.850		
		1,5 m kg	*2.800	*2.800	*5.100	3.750	*6.800	5.800				
		0,0 m kg	*3.150	3.100	*5.100	3.700	*7.050	5.600	*7.700	*7.700		
	2,5 m	-1,5 m kg	*3.900	3.450	*4.450	3.650	*6.400	5.550	*9.200	*9.200	*6.350	*6.350
		-3,0 m kg	*3.500	*3.500			*4.600	*4.600	*6.550	*6.550		
		7,5 m kg										
		6,0 m kg	*2.350	*2.350	*2.550	*2.550						
		4,5 m kg	*2.250	*2.250	*4.150	4.000						
		3,0 m kg	*2.250	*2.250	*4.700	3.900	*5.700	*5.700	*8.050	*8.050		
3,0 m	1,5 m kg	*2.350	*2.350	*5.050	3.800	*6.650	5.850	*10.050	*10.050			
	0,0 m kg	*2.650	*2.650	*5.150	3.700	*7.050	5.650	*8.150	*8.150			
	-1,5 m kg	*3.150	*3.150	*4.750	3.650	*6.700	5.550	*9.800	*9.800	*5.750	*5.750	
	-3,0 m kg	*3.600	*3.600			*5.250	*5.250	*7.550	*7.550			
	7,5 m kg	*2.300	*2.300									
	6,0 m kg	*2.000	*2.000	*3.300	*3.300							
 Outrigger front + rear	2,1 m	4,5 m kg	*1.850	*1.850	*3.950	*3.950						
		3,0 m kg	*1.850	*1.850	*3.050	2.700	*4.350	3.900	*5.150	*5.150		
		1,5 m kg	*1.950	*1.950	*3.600	2.700	*4.750	3.750	*6.200	5.850	*9.750	*9.750
		0,0 m kg	*2.100	*2.100	*3.350	2.650	*5.050	3.600	*6.850	5.550	*8.600	*8.600
		-1,5 m kg	*2.500	*2.500	*4.850	3.550	*6.750	5.450	*10.250	*10.250	*5.000	*5.000
		-3,0 m kg	*3.300	*3.300	*3.850	3.600	*5.700	5.400	*8.400	*8.400	*8.050	*8.050
	2,5 m	7,5 m kg										
		6,0 m kg	*2.850	*2.850								
		4,5 m kg	*2.700	*2.700	*4.050	*4.050	*5.150	*5.150				
		3,0 m kg	*2.700	*2.700	*4.850	*4.850	*6.050	*6.050	*8.850	*8.850		
		1,5 m kg	*2.800	*2.800	*5.100	4.800	*6.800	*6.800				
		0,0 m kg	*3.150	*3.150	*5.100	4.700	*7.050	*7.050	*7.700	*7.700		
3,0 m	-1,5 m kg	*3.900	*3.900	*4.450	*4.450	*6.400	*6.400	*9.200	*9.200	*6.350	*6.350	
	-3,0 m kg	*3.500	*3.500			*4.600	*4.600	*6.550	*6.550			
	7,5 m kg											
	6,0 m kg	*2.350	*2.350	*2.550	*2.550							
	4,5 m kg	*2.250	*2.250	*4.150	*4.150							
	3,0 m kg	*2.250	*2.250	*4.700	*4.700	*5.700	*5.700	*8.050	*8.050			
3,0 m	1,5 m kg	*2.350	*2.350	*5.050	4.800	*6.650	*6.650	*10.050	*10.050			
	0,0 m kg	*2.650	*2.650	*5.150	4.700	*7.050	*7.050	*8.150	*8.150			
	-1,5 m kg	*3.150	*3.150	*4.750	4.650	*6.700	*6.700	*9.800	*9.800	*5.750	*5.750	
	-3,0 m kg	*3.600	*3.600			*5.250	*5.250	*7.550	*7.550			
	7,5 m kg	*2.300	*2.300									
	6,0 m kg	*2.000	*2.000	*3.300	*3.300							

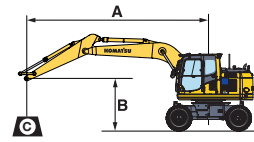

A – Reach from swing center

B – Bucket hook height

C – Lifting capacities, including bucket linkage (84 kg) and bucket cylinder (96 kg)

 – Rating over front

 – Rating over side













 – Rating at maximum reach

When removing linkage or cylinder, lifting capacities can be increased by their respective weights.



* Load is limited by hydraulic capacity rather than tipping. Ratings are based on SAE Standard No. J1097. Rated loads do not exceed 87% of hydraulic lift capacity or 75% of tipping load.

Lifting Capacity

TWO-PIECE BOOM

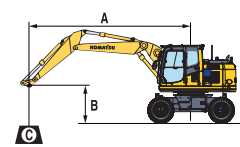
Arm length	A	7,5 m		6,0 m		4,5 m		3,0 m		1,5 m		
												
 Without stabilizer	2,1 m	7,5 m kg	*3.550	3.300				*3.700	3.300			
		6,0 m kg	2.850	2.100		2.850	2.100	*4.050	3.450			
		4,5 m kg	2.250	1.650		2.800	2.100	4.500	3.300			
		3,0 m kg	1.950	1.500		2.700	2.000	4.250	3.050			
		1,5 m kg	1.950	1.350		2.550	1.900	4.000	2.700			
		0,0 m kg	1.950	1.450		2.550	1.800	3.850	2.700			
	2,5 m	-1,5 m kg	2.200	1.600		2.550	1.800	3.800	2.650	7.250	4.800	
		-3,0 m kg										
		7,5 m kg	*2.850	2.750				*3.950	3.450			
		6,0 m kg	*2.400	1.850		2.950	2.150					
		4,5 m kg	2.100	1.500		2.900	2.100	4.350	3.350			
		3,0 m kg	1.800	1.350	1.950	1.400	2.800	2.050	4.350	3.150		
	3,0 m	1,5 m kg	1.800	1.300	1.950	1.400	2.550	1.900	4.050	2.850		
		0,0 m kg	1.800	1.350	1.900	1.350	2.550	1.800	3.600	2.700	*5.450	4.750
		-1,5 m kg	2.050	1.450			2.550	1.800	3.800	2.650	7.200	4.700
		-3,0 m kg	2.650	1.850					3.750	2.700		
		7,5 m kg	*2.300	2.150								
		6,0 m kg	*2.000	1.600		2.950	2.150					
 Front or rear blade	2,1 m	7,5 m kg	*3.550	*3.550				*3.700	*3.650			
		6,0 m kg	*2.900	2.400		*3.050	2.450	*4.050	3.950			
		4,5 m kg	2.550	1.950		3.200	2.450	5.000	3.800			
		3,0 m kg	2.100	1.750		3.100	2.350	4.750	3.600			
		1,5 m kg	2.050	1.650		3.000	2.250	4.500	3.350			
		0,0 m kg	2.100	1.700		2.700	2.200	4.350	3.200			
	2,5 m	-1,5 m kg	2.250	1.900		2.900	2.150	4.300	3.150	8.250	5.750	
		-3,0 m kg										
		7,5 m kg	*2.850	*2.850				*3.950	*3.950			
		6,0 m kg	*2.400	2.200		3.300	2.550					
		4,5 m kg	2.250	1.800		3.250	2.500	4.750	3.900			
		3,0 m kg	2.150	1.650	2.100	1.700	3.000	2.400	4.800	3.650		
	3,0 m	1,5 m kg	2.100	1.550	2.200	1.650	2.750	2.250	4.550	3.400		
		0,0 m kg	2.100	1.600	1.950	1.650	2.650	2.200	4.350	3.200	*5.450	*5.450
		-1,5 m kg	2.100	1.750			2.700	2.150	4.300	3.150	8.150	5.700
		-3,0 m kg	3.000	2.250					4.350	3.200		
		7,5 m kg	*2.300	*2.300								
		6,0 m kg	*2.000	1.850		3.150	2.550					
 Rear outrigger	2,1 m	7,5 m kg	*3.550	*3.550				*3.700	*3.650			
		6,0 m kg	*2.900	*2.950		*3.050	*3.000	*4.050	*4.000			
		4,5 m kg	*2.700	2.500		3.450	3.150	5.000	4.900			
		3,0 m kg	2.400	2.250		3.300	3.000	5.100	4.650			
		1,5 m kg	2.350	2.150		3.200	2.900	4.850	4.350			
		0,0 m kg	2.400	2.250		3.100	2.850	4.700	4.200			
	2,5 m	-1,5 m kg	2.750	2.500		3.150	2.850	4.650	4.200	*8.500	7.950	
		-3,0 m kg										
		7,5 m kg	*2.850	*2.850				*3.950	*3.950			
		6,0 m kg	*2.400	*2.400		3.500	3.200					
		4,5 m kg	*2.300	*2.300		3.500	3.150	*4.950	*4.950			
		3,0 m kg	*2.250	2.100	2.400	2.200	3.400	3.050	5.200	4.700		
	3,0 m	1,5 m kg	2.250	2.000	2.400	2.100	3.300	2.950	4.900	4.400		
		0,0 m kg	2.250	2.100	2.350	2.100	3.150	2.850	4.700	4.200	*5.450	*5.450
		-1,5 m kg	2.550	2.250			2.950	2.800	4.650	4.200	8.100	7.850
		-3,0 m kg	3.200	2.900					4.700	4.200		
		7,5 m kg	*2.300									
		6,0 m kg	*2.000			3.550	3.200					















- A – Reach from swing center
 - B – Bucket hook height
 - C – Lifting capacities, including bucket linkage (84 kg) and bucket cylinder (96 kg)
-  – Rating over front
 -  – Rating over side
 -  – Rating at maximum reach

When removing linkage or cylinder, lifting capacities can be increased by their respective weights.

* Load is limited by hydraulic capacity rather than tipping. Ratings are based on SAE Standard No. J1097. Rated loads do not exceed 87% of hydraulic lift capacity or 75% of tipping load.

TWO-PIECE BOOM

Arm length	A	7,5 m		6,0 m		4,5 m		3,0 m		1,5 m					
															
 Outrigger + blade	2,1 m	7,5 m	kg	*3.550	*3.550			*3.700	*3.700						
		6,0 m	kg	*2.900	*2.900			*3.050	*3.050	*4.050	*4.050				
		4,5 m	kg	*2.700	*2.700			*4.100	3.950	*5.200	*5.200				
		3,0 m	kg	*2.700	*2.700			*4.350	3.850	*5.850	*5.850				
		1,5 m	kg	*2.750	2.700			*4.700	3.750	*6.850	5.700				
		0,0 m	kg	*3.050	2.850			*5.050	3.650	*6.900	5.550				
	2,5 m	-1,5 m	kg	*3.550	3.150			*4.450	3.600	*6.200	5.500	*8.500	*8.500		
		-3,0 m	kg												
		7,5 m	kg	*2.850	*2.850					*3.950	*3.950				
		6,0 m	kg	*2.400	*2.400			*3.750	*3.750						
		4,5 m	kg	*2.300	*2.300			*4.000	*4.000	*4.950	*4.950				
		3,0 m	kg	*2.250	*2.250	*3.350	2.650	*4.200	3.900	*5.600	*5.600				
	3,0 m	1,5 m	kg	*2.350	*2.350	*3.600	2.700	*4.600	3.750	*6.600	5.750				
		0,0 m	kg	*2.550	*2.550	*3.350	2.700	*5.000	3.650	*6.950	5.550	*5.450	*5.450		
		-1,5 m	kg	*2.950	2.900			*4.700	3.600	*6.450	5.500	*8.600	*8.600		
		-3,0 m	kg	*3.400	*3.400					*5.100	*5.050				
		7,5 m	kg	*2.300	*2.300										
		6,0 m	kg	*2.000	*2.000			*3.700	*3.700						
 Outrigger front + rear	2,1 m	4,5 m	kg	*1.900	*1.900	*3.000	2.700	*3.750	*3.750	*3.850	*3.850				
		3,0 m	kg	*1.850	*1.850	*3.250	2.700	*4.000	3.850	*5.200	*5.200				
		1,5 m	kg	*1.900	*1.900	*3.350	2.650	*4.300	3.700	*6.050	5.750				
		0,0 m	kg	*2.050	*2.050	*3.600	2.600	*4.700	3.600	*6.800	5.500	*5.700	*5.700		
		-1,5 m	kg	*2.350	*2.350	*3.250	2.550	*4.750	3.500	*6.550	5.400	*7.800	*7.800	*3.900	*3.900
		-3,0 m	kg	*2.800	*2.800			*3.850	3.550	*5.550	5.400	*7.800	*7.800		
	2,5 m	7,5 m	kg	*3.550	*3.550					*3.700	*3.700				
		6,0 m	kg	*2.900	*2.900			*3.050	*3.050	*4.050	*4.050				
		4,5 m	kg	*2.700	*2.700			*4.100	*4.100	*5.200	*5.200				
		3,0 m	kg	*2.700	*2.700			*4.350	*4.350	*5.850	*5.850				
		1,5 m	kg	*2.750	*2.750			*4.700	*4.700	*6.850	*6.850				
		0,0 m	kg	*3.050	*3.050			*5.050	4.350	*6.900	*6.900				
	3,0 m	-1,5 m	kg	*3.550	*3.550			*4.450	*4.450	*6.200	*6.200	*8.500	*8.500		
		-3,0 m	kg												
		7,5 m	kg	*2.850	*2.850					*3.950	*3.950				
		6,0 m	kg	*2.400	*2.400			*3.750	*3.750						
		4,5 m	kg	*2.300	*2.300			*4.000	*4.000	*4.950	*4.950				
		3,0 m	kg	*2.250	*2.250	*3.350	*3.350	*4.200	*4.200	*5.600	*5.600				
2,5 m	1,5 m	kg	*2.350	*2.350	*3.600	3.300	*4.600	*4.600	*6.600	*6.600					
	0,0 m	kg	*2.550	*2.550	*3.350	*3.350	*5.000	4.650	*6.950	*6.950	*5.450	*5.450			
	-1,5 m	kg	*2.950	*2.950			*4.700	4.650	*6.450	*6.450	*8.600	*8.600			
	-3,0 m	kg	*3.400	*3.400					*5.100	*5.100					
	7,5 m	kg	*2.300	*2.300											
	6,0 m	kg	*2.000	*2.000			*3.700	*3.700							
3,0 m	4,5 m	kg	*1.900	*1.900	*3.000	*3.000	*3.750	*3.750	*3.850	*3.850					
	3,0 m	kg	*1.850	*1.850	*3.250	*3.250	*4.000	*4.000	*5.200	*5.200					
	1,5 m	kg	*1.900	*1.900	*3.350	3.150	*4.300	*4.300	*6.050	*6.050					
	0,0 m	kg	*2.050	*2.050	*3.600	3.050	*4.700	4.600	*6.800	*6.800	*5.700	*5.700			
	-1,5 m	kg	*2.350	*2.350	*3.250	3.050	*4.750	4.250	*6.550	*6.550	*7.800	*7.800	*3.900	*3.900	
	-3,0 m	kg	*2.800	*2.800			*3.850	*3.850	*5.550	*5.550	*7.800	*7.800			

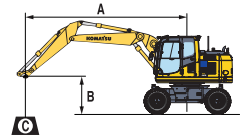

A – Reach from swing center

B – Bucket hook height

C – Lifting capacities, including bucket linkage (84 kg) and bucket cylinder (96 kg)

 – Rating over front

 – Rating over side

 – Rating at maximum reach

When removing linkage or cylinder, lifting capacities can be increased by their respective weights.

* Load is limited by hydraulic capacity rather than tipping. Ratings are based on SAE Standard No. J1097. Rated loads do not exceed 87% of hydraulic lift capacity or 75% of tipping load.

Hydraulic Wheeled Excavator

PW148-10

Standard and Optional Equipment

ENGINE

Komatsu SAA4D107E-2 turbocharged common rail direct injection diesel engine	●
EU Stage IIIB compliant	●
Suction type cooling fan	●
Automatic engine warm-up system	●
Engine overheat prevention system	●
Auto-deceleration function	●
Engine ignition can be password secured on request	●
Batteries 2 × 12 V/120 Ah	●

HYDRAULIC SYSTEM

Electronic closed-centre load sensing (E-CLSS) hydraulic system (HydrauMind)	●
Pump and engine mutual control (PEMC) system	●
6-working mode selection system; power mode, economy mode, breaker mode, attachment power and attachment economy mode, and lifting mode	●
PowerMax function	●
Adjustable PPC wrist control levers for arm, boom, bucket and swing, with sliding proportional control for attachments and 5 auxiliary buttons, with FNR switch	●
Additional hydraulic circuit (HCU-B)	●
Additional hydraulic circuit (HCU-C)	○
Prepared for hydraulic quick-coupler	○

SERVICE AND MAINTENANCE

Automatic fuel line de-aeration	●
Double element type air cleaner with dust indicator and auto dust evacuator	●
KOMTRAX™ – Komatsu wireless monitoring system	●
Multifunction video compatible colour monitor with Equipment Management and Monitoring System (EMMS) and efficiency guidance	●
Toolkit	●
Komatsu CARE™	●
Centralised greasing system	●
Automatic greasing system	○

CABIN

SpaceCab™; Highly pressurised and tightly sealed hyper viscous mounted cab with tinted safety glass windows, large roof window with sun shade, pull-up type front window with locking device, removable lower window, front window wiper with intermittent feature, sun roller blind, cigarette lighter, luggage shelf, floor mat	●
Heated air suspension seat with lumbar support, arm rests and retractable seat belt	●
Automatic climate control system	●
12/24 Volt power supplies	●
Beverage holder and magazine rack	●
Hot and cool box	●
CD radio with auxiliary input (MP3 jack)	○
Heated, adjustable, suspended seat	○
Lower wiper	○
Rain visor (not with OPG)	○

SAFETY EQUIPMENT

Rear-view camera system	●
Electric horn	●
Overload warning device	●
Lockable fuel cap and covers	●
Audible travel alarm	●
Large handrails, rear-view mirrors	●
Battery main switch	●
Boom safety valves	●
Arm safety valve	●
Adjust cylinder safety valve	●
OPG Level II front guard (FOPS)	○
OPG Level II top guard (FOPS)	○
Audible travel alarm (white noise version)	○
Side-view camera system	○
Super tone horn (no road approval)	○

WORK EQUIPMENT

Mono boom	○
Two-piece boom	○
2,1 m; 2,5 m; 3,0 m arms	○
Clamshell grip bar	○

UNDERCARRIAGE

Parallel blade (front and/or rear) with cylinder protection	○
2 or 4 outriggers with cylinder protection, individually adjustable	○
Twin tyres 10.00-20 16 PR	○
Twin tyres Bandenmarkt Excavator 315/70 R22.5	○
Twin tyres Nokian 10-20 (L5)	○
Single tyres Michelin 18.00-19.5	○
Tyres Bandenmarkt Grader 315/70 R22.5	○
Fenders	○

DRIVES AND BRAKES

Fully automatic 3-speed transmission driving through front and rear planetary axles	●
Oscillating front axle (10°) with automatic and manual cylinder locking	●
Cruise control	●
20, 25 or 35 km/h speed limitation	○
Transmission guard	○

LIGHTING SYSTEM

Working lights: 2 revolving frame, 1 counterweight (rear)	●
Additional RH & LH boom lamp	○
LED working lights	○
Beacon + rear facing cab lamp	○
1 or 2 additional beacons on counterweight	○
Additional large capacity cab roof lights (4)	○
2 additional LED working lights boom foot	○

OTHER EQUIPMENT

Standard counterweight	●
Electric refuelling pump with automatic shut off function	●
Single chassis tool box	●
Additional chassis tool box	○
Biodegradable oil for hydraulic system	○
Customised paint	○

Further equipment on request

- standard equipment
- optional equipment

KOMATSU

**Komatsu Europe
International N.V.**
Mechelsesteenweg 586
B-1800 VILVOORDE (BELGIUM)
Tel. +32-2-255 24 11
Fax +32-2-252 19 81
www.komatsu.eu

Your Komatsu partner:

VENSS05303 02/2017

KOMATSU is a trademark of Komatsu Ltd. Japan.