



HYDRAULIC BREAKERS



DURABLE AND RELIABLE

WHERE **EXPERIENCE COUNTS**

TRADITION AND HIGH-TECH FROM ONE COUNTRY.

Japan, a country of old traditions, has proven its high technical performances in many different ways. Already many years ago Japanese electronic equipment contributed greatly to the possibility to reach the moon and other planets. In almost every computer, telephone or any other kind of electronic equipment we can find some Japanese components. In the car industry Japanese engineers have achieved high performances in order to produce more efficient and economical cars. Car tests in different countries have often concluded that Japanese cars are the most reliable and with a minimum of maintenance cost. Also Furukawa is one of those traditional concerns that could show continuous growth through their ongoing product improvement and development. Everything started in 1875, when Furukawa opened their Kusakura Copper Mine. The mining always required new and specific solutions to improve ore production. For this reason Furukawa started in 1900 to produce their own mining equipment, which led to higher production levels at the mine.

With this step Furukawa unintentionally created the base for a new, high technology concern. The better results with their custom-made machinery soon created a demand for similar machines in other mines. To be able to fulfil these requirements, Furukawa started to separate their activities into different divisions.

In 1918 Furukawa Mining Co. Ltd was founded and in 1920 Furukawa Electric Co. Ltd. Later in 1961 the start of Furukawa Rock Drill Co. Ltd was an answer to the demand to be able to sell worldwide the machines, that initially were meant only for their own use. In 1971 Furukawa established a new factory in Yoshii for the production of crawler drills and demolition equipment.

The demand for those products was so large, that in 1976 a second production unit was established in Takasaki.

Since then, from these two factories, more than 150.000 hydraulic breakers have been delivered all over the world.

In the meantime the Furukawa Rock Drill division has built an international sales and service network, which secures an optimum after sales service for all the equipment. We take our slogan " FRD – WHERE EXPERIENCE COUNTS" as serious as other Japanese traditions and we hope you will approach us with your specific demands. We and our dealer network are ready to help you.



INSIDE FURUKAWA

Contents

Inside Furukawa	1/2
Compatibility	3/4
Performance	5/6
Find the correct FX series breaker	7/8
FX series breaker the design	9/10
FX series the best frame / Noise level	11/12
FX 15	13/14
FX 25	15/16
FX 35	17/18
FX 45	19/20
FX 55	21/22
Find the correct MEDIUM series breaker	23/24
F6 F9 breaker the design	25/26
F6 BHL	27/28
F6	29/30
F9 LN	31/32
Find the correct LARGE series breaker	33/34
XP series breaker the design	35/36
Central lubrication / Grease options	37/38
XP series self cleaning channel	39/40
F12 XP	41/42
F19 XP	43/44
F22 XP	45/46
F27 XP	47/48
F35 XP	49/50
F45 XP	51/52
F70 XP	53/54
F100 XP	55/56
Options	57/58
Rods	59/62
More FRD products	63/64
Global Distributor Network	65/66



WHERE **EXPERIENCE COUNTS**

COMPATIBILITY TABLE FRD HYDRAULIC BREAKERS

SMALL AND MEDIUM SERIES

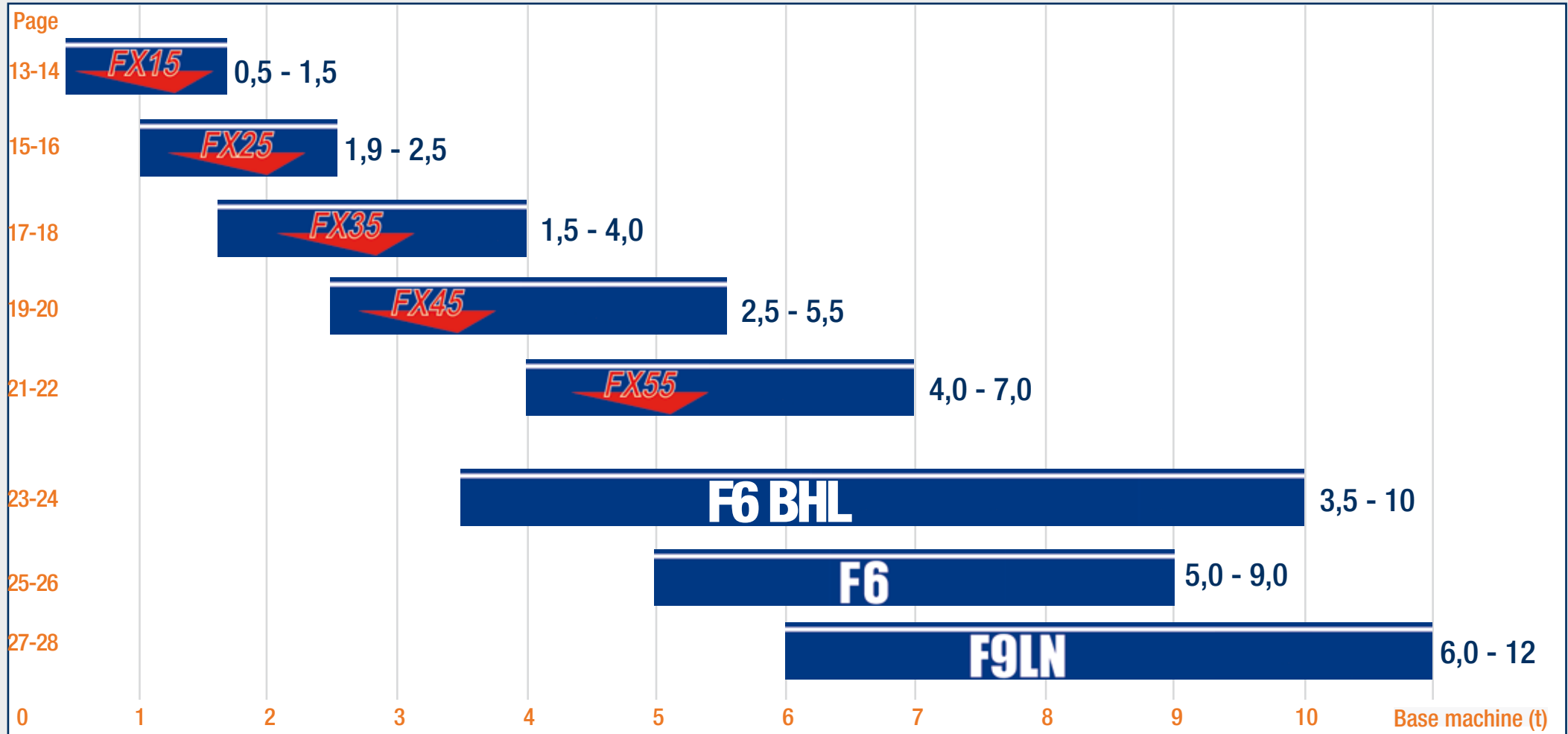

COMPATIBILITY

LARGE SERIES

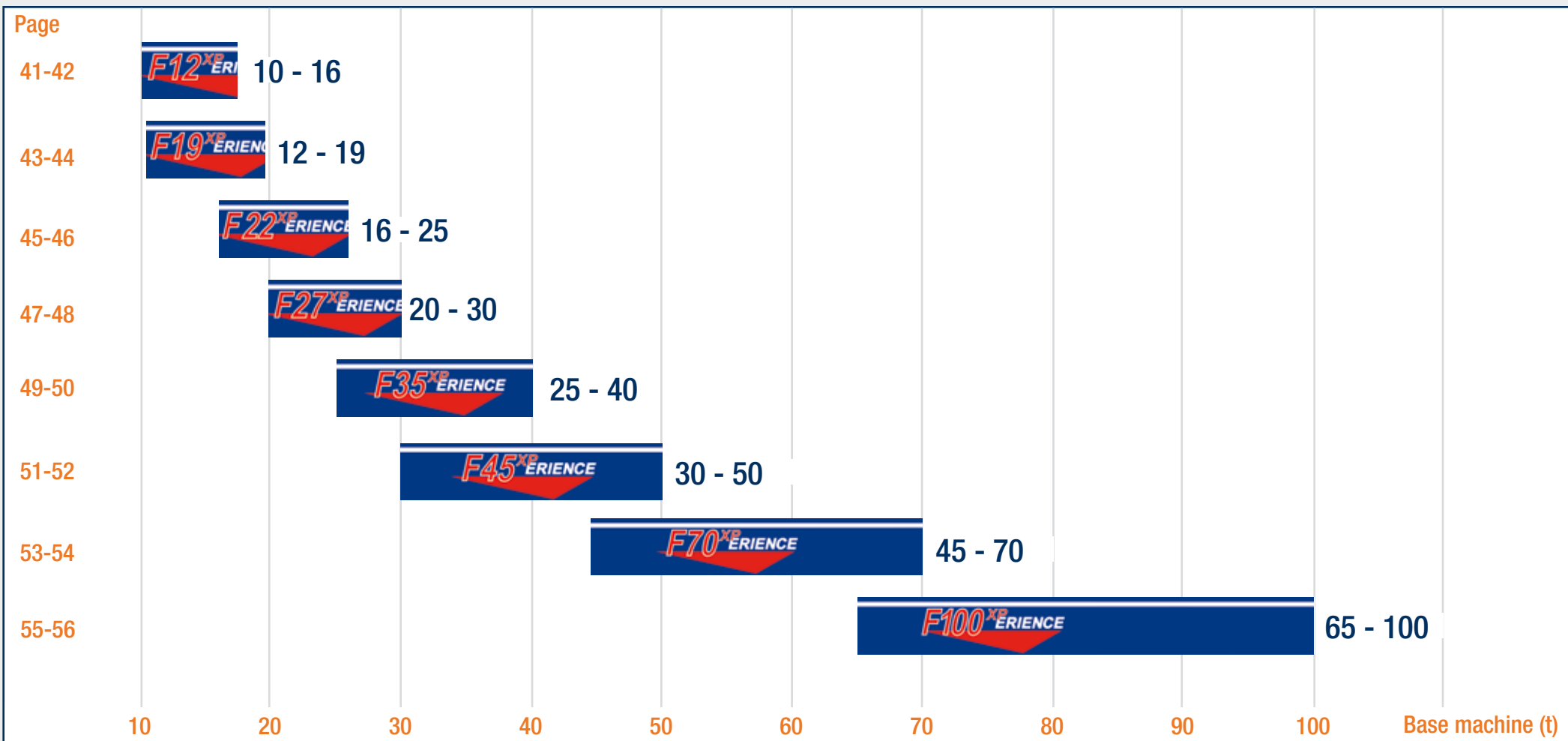

WHERE **EXPERIENCE COUNTS**

PERFORMANCE TABLE FRD HYDRAULIC BREAKERS

SMALL AND MEDIUM SERIES

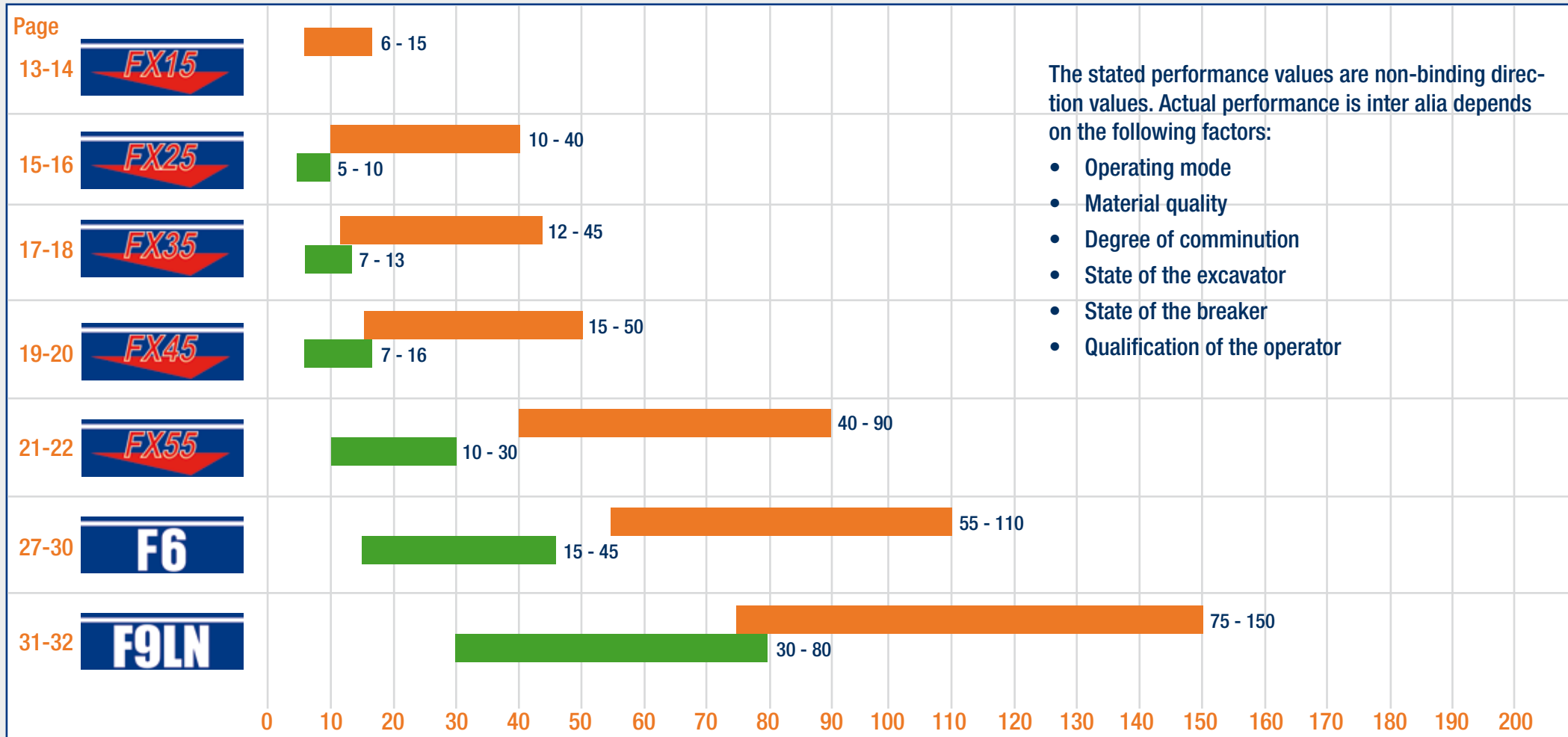

PERFORMANCE

LARGE SERIES

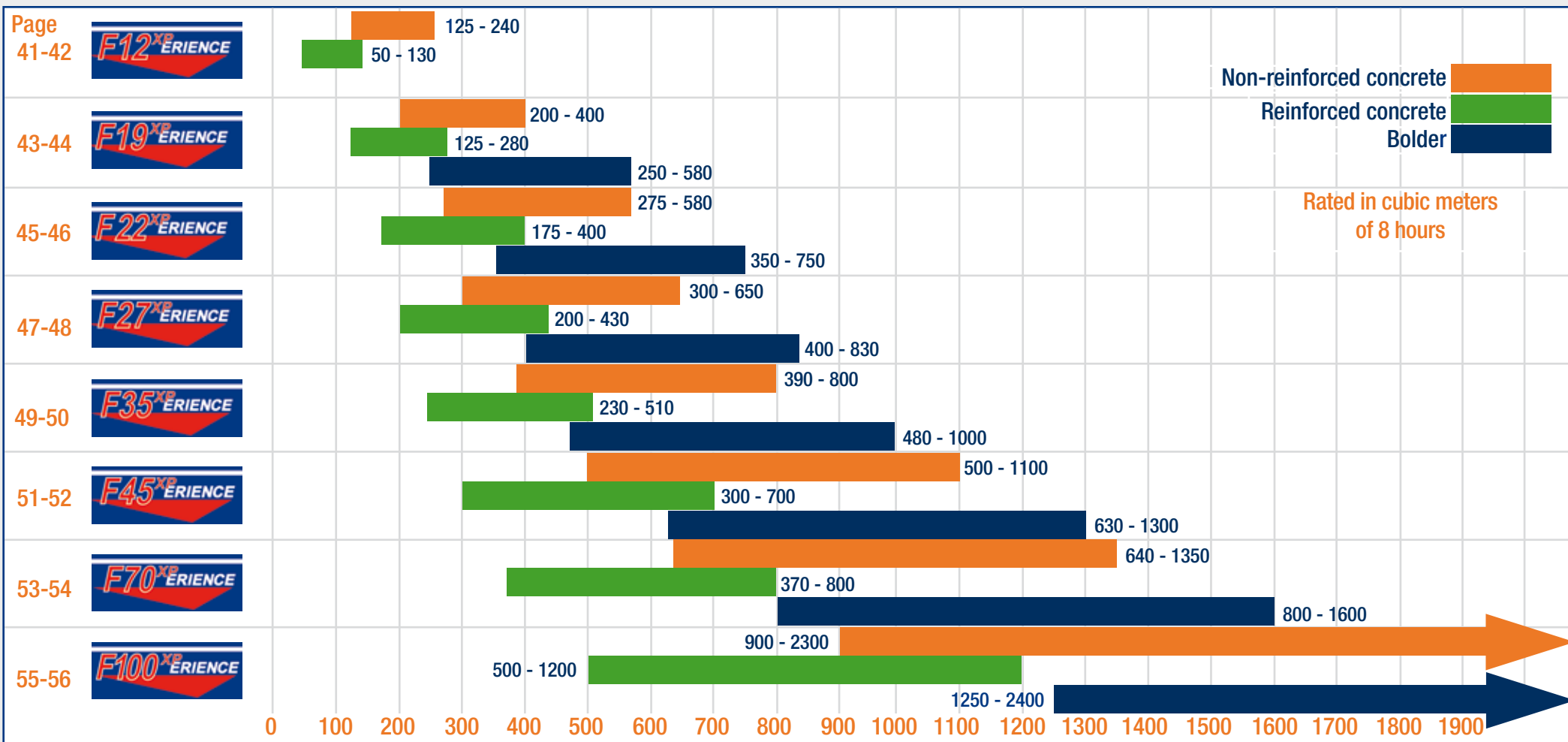

WHERE **EXPERIENCE COUNTS**

FIND THE FX SERIES BREAKER THAT SUITS YOU



SMALL HYDRAULIC BREAKERS



	Job	Specification	
Construction	Gardening & landscaping	Fencing, ground excavation, rock breaking	●
	Earthworks	Trenching, Pit building, Ground excavation	●
	Dredging	Canal deepening & extension Dock deepening & extension	●
	Tunnelling	Tunnel driving, Roof, face & rib scaling Floor levelling	●
Demolition & renovation	Masonry structures	Brickwork, Natural stone Autoclaved aerated concrete	●
	Concrete structures	Lightweight concrete Standard concrete	●
	Pavements	Asphalt, Concrete, Composite surfaces	●
	Composite steel & concrete structures	Steel-reinforced concrete, pre-stressed concrete, Fibre-reinforced concrete	●
Mining & quarrying	Preliminary works	Overburden removal, Bench, road & ramp levelling, Roof, face & rib scaling	●
	Secondary breaking	Boulder reduction in rock pile, Removing blockages at crushing systems	●
Metallurgical industry	Cleaning & de-bricking	Ladles, Converter mouths, Kilns	●
	Slag recycling	Boulder reduction in slag heap, Removing blockages at crushing systems	●

● Optimal ● Suitable

WHERE **EXPERIENCE COUNTS**

FX-THE REVOLUTION IN MINI EXCAVATOR BREAKERS

Newly designed Mono Bloc Cylinder without through bolts, easy exchangeable wear parts, more power at lower noise levels, all in the world famous FRD quality! As the first world producer of hydraulic hammers FRD follows the EU guidelines to drastically minimize noise and vibration at the working place. In cooperation with the Technical University of Tokyo, FRD could greatly reduce the new breakers noise levels. A complete new development of the impact mechanism minimizes the discharge of vibration to the excavator, as well reduces the operators vibration stress drastically. In relation with this new developed breaker body, the fully closed frame with rubber plugged service points and a new, worldwide patented, rod arrangement, a considerable reduction in sound levels of 7db could be achieved. Because FRD optimized the applied materials with a new hardness process, a higher efficiency at same operation weight is guaranteed. The five FX series hydraulic breakers are available with an operation weight of 66 to 300 kg and are designated for mini excavators from 0,5 to 7 tons. All breakers are equipped with an adjustable flow and pressure device, which secures the optimal interaction between the attachment and the excavator at any time. It's natural for FRD that the FX series are equipped with easy exchangeable wear parts. These high quality parts provide a long lifetime of the breakers for the professional users, like rental and demolition companies. On this FRD High Tech attachment easy maintenance for the operator and mechanic are guaranteed. The front bushing can be replaced easily. The easy access to the rod pin makes it simple and easy to replace the rod. As usual FRD has 3 different frame types for all models available:

- 1) FX 15 up to FX 55 Series in the standard frame version
- 2) FX 25 S up to FX 55 S Series in a silent version
- 3) FX 25 XS up to FX 55 XS Series in the extra silent version.

With the new FX Series, FRD provides their customers with the most suitable, silent and powerful attachment for the coming years.

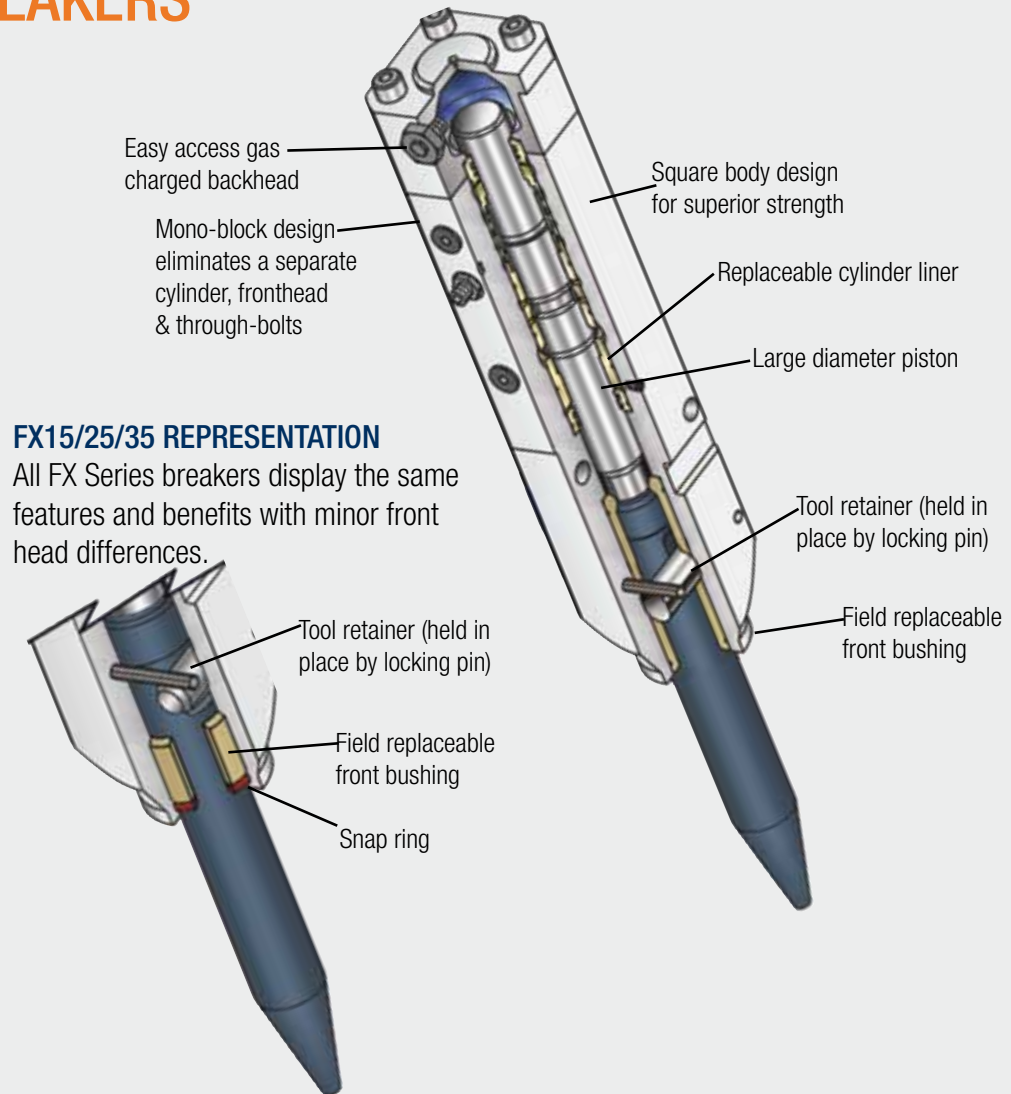

FX15/25/35 REPRESENTATION

All FX Series breakers display the same features and benefits with minor front head differences.

SMALL HYDRAULIC BREAKERS

FX15/25/35

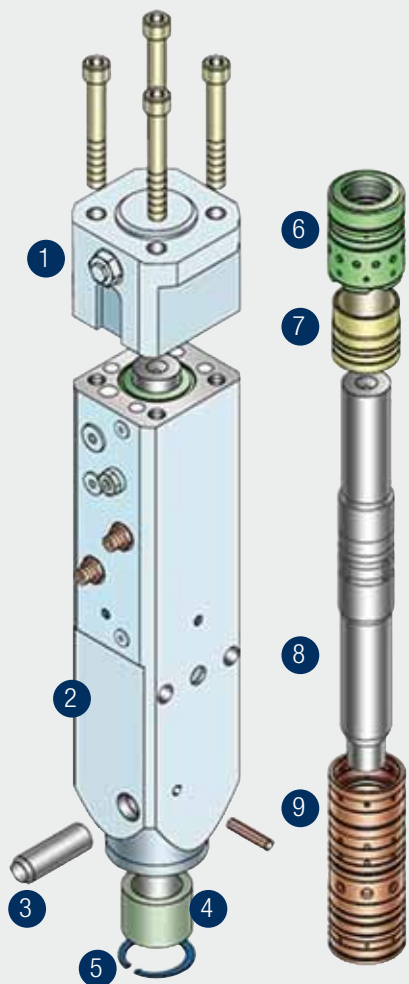

1. Back Head
2. Mono-Block Cylinder
3. Retainer Pin
4. Front Bushing
5. Snap Ring
6. Seal Retainer
7. Valve
8. Piston
9. Cylinder Liner

FX45/55

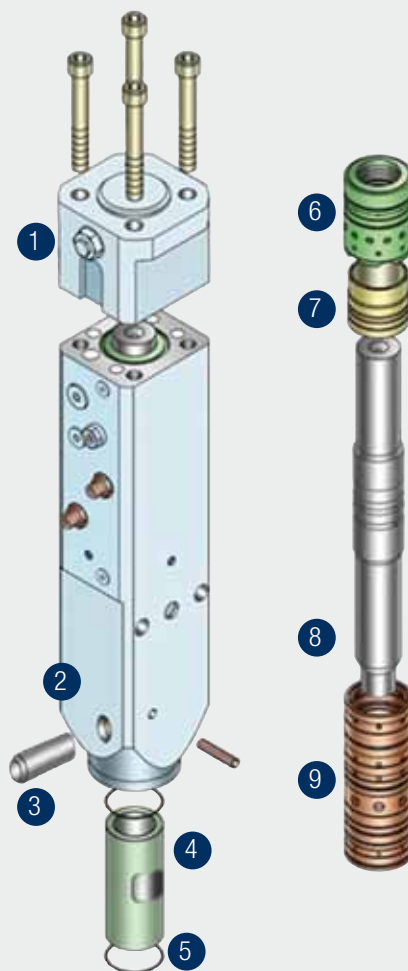

1. Back Head
2. Mono-Block Cylinder
3. Oval Retainer Pin
4. Front Bushing
5. Top & Bottom O-Rings
6. Seal Retainer
7. Valve
8. Piston
9. Cylinder Liner

FEATURES AND BENEFITS:

- Mono-block design with only two moving parts reduces maintenance
- No through bolts to maintain
- Designed with replaceable cylinder liners saving maintenance cost and downtime
- No diaphragm to replace
- Field replaceable front wear bushing keeps tools in peak performance
- Extended front head bushing keeps steel in proper alignment for maximum service life (Fx45/55)
- Wide oil flow range for fast, hard-hitting performance and more carrier options
- A wide variety of working steels
- Oval retaining pin for increased steel contact and double service life (Fx45/55)
- Two strategically located warehouse facilities with extensive tool inventories assuring on-time deliveries

THE BEST FRAME FOR YOUR REQUEST

FOR EACH REQUEST, THE OPTIMUM BREAKER FRAME.

PIN AND BUSH



The easiest way to fix a hydraulic breaker on an excavator. Order the appropriate pin & bushing set and you can fix your hydraulic breaker on an excavator arm.

FLATTOP



The cheapest solution is to attach the hydraulic breaker with different systems. With the FT frame, you can attach the breaker using base mounting plates for quick-change systems of all kinds

SILENCE



Noise reduction is required in the workplace, and you have the beginning of the Silence part of our offered possibilities. The frame is up to 6 Db(A) quieter than the standard frame

XTRA SILENCE



With the Xtra frame we currently offer the maximum in noise reduction. The optimal management of the hammer in the frame in conjunction with the patented design of the FRD rod gives up to 4 Db(A) noise reduction than the Silence version.

FX TYPE FRAME / NOISE-LEVEL

„SOUND POWER“ AND „SOUND PRESSURE“

These are two distinct and commonly confused characteristics of sound. Sound power is the acoustical energy emitted by the sound source, and is an absolute value. It is not affected by the environment. Sound power levels are connected to the sound source and are independent of distance. Sound power levels are indicated in decibels.

Sound power is measured as the total sound power emitted by a source in all directions in watts (joules per second).

Since sound measuring instruments respond to sound pressure the „decibel“ is generally associated with sound pressure level (SPL). Sound pressure levels quantify in decibels the intensity of given sound sources. Sound pressure levels vary substantially with distance from the source, and also diminish as a result of intervening obstacles and barriers, air absorption, wind and other factors. Sound pressure levels are indicated in decibels.

Sound pressure is a pressure disturbance in the air whose intensity is influenced not only by the strength of the source, but also by the surroundings and the distance from the source to the receiver. Sound pressure is what our ears hear and what sound pressure level meters (SPL meters) measure.

$$L_{wA,g} = L_{p'} - k_1 - k_2 + 10 \cdot \log(s/s_0) + K$$

SOUND POWER



SOUND PRESSURE

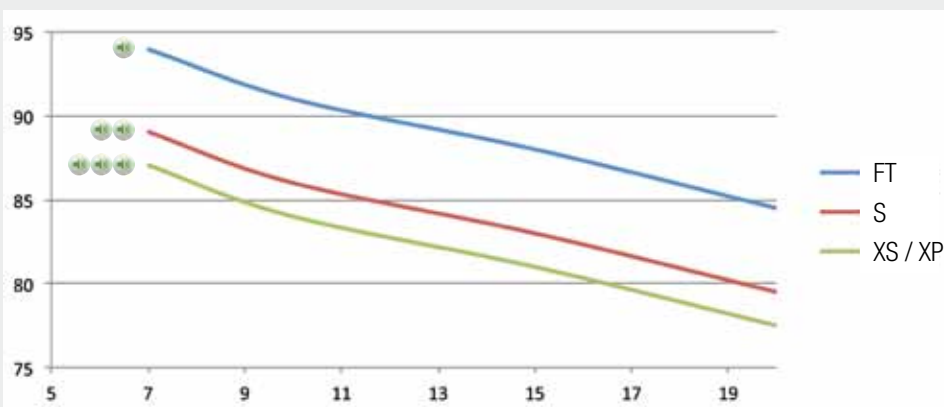

SOUND MEASURING STAND

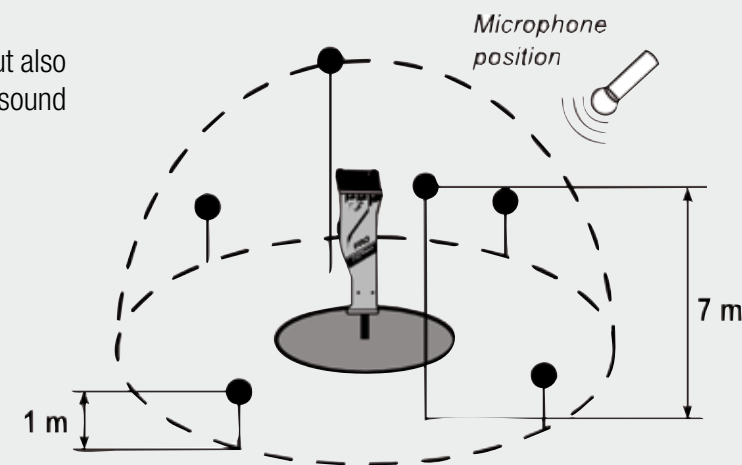
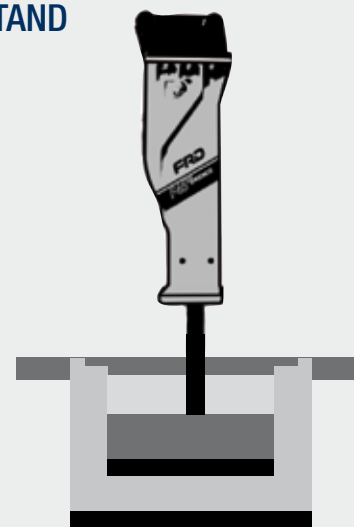

Half sphere measurement radius $r = 10\text{ m}$

$$L_{wA,g} = L_{p'} - k_1 - k_2 + 10 \cdot \log(s/s_0) + K$$

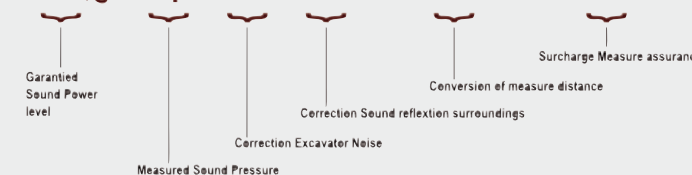

More mounting options - less maintenance

The unique mono-block design is a result of years of engineering refinement and field experience. Two moving parts simplifies the breaker operation and reduces the chance of downtime. The advanced hydraulic circuit provides increased flow to the valve and piston, resulting in faster cycle times, increased rod penetration and more productivity per hour than on previous models. There are no through bolts to constantly torque or replace and the front wear bushing is easily replaced so your breaker is always in perfect working condition. The wider oil flow range is an example of the breakers superior design, allowing for faster striking speeds and the ability to be used on a wider range of carriers. The nitrogen charged back head increases the impact energy maximizing breaker production.

In the rare event that maintenance is needed, the Fx Series has been designed with replaceable cylinder liners saving maintenance cost and downtime.

Due to a small footprint, these breakers are ideal for use in tight work envelopes, pavement, driveway removal or any other demolition task. The Fx15 is available for use on mini-excavators. Mounting options are endless and can accommodate any carrier, or a combination of carriers or specific applications.



FX15

		FX15	
Operating weight, pin and bush ¹⁾	kg	69	
Operating weight, FT ¹⁾	kg	69	
Height with rod, pin and bush	mm	924	
Height with rod, FT	mm	816	
Height with rod, S	mm		
Height with rod, XS	mm		
Operating pressure	min	MPa	10
	max		14
Oil flow	min	l/min	10
	max		22
Impact rate (frequency)	min	bpm	600
	max		1500
Rod diameter Ø	mm	36	
Effective rod length	mm	234	
Weight rod (standard)	kg	2,6	
Hose inner dia Ø Press, Return	mm	9	
Base machine weight	ton	0,5 - 1,5	

¹⁾ Operating weight with top bracket.

Specifications subject to change without notice

TYPE OF ROD

- Flat rod
- Moil point rod
- Wedge point rod
- Asphalt spad rod
- Wide rod
- Ball point rod



SOUND PRESSURE

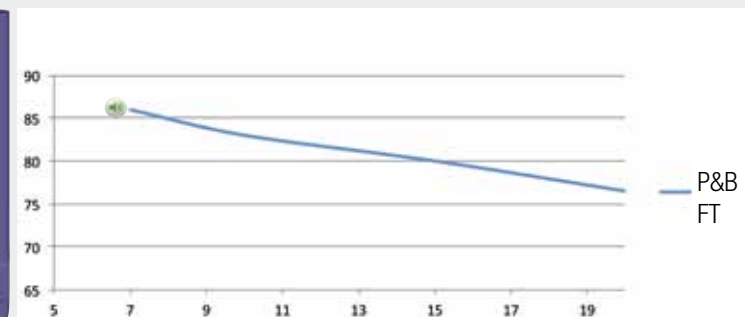

P&B



FT

CAPABILITIES

- Overburden removal. Bench, road & ramp levelling
- Brickwork, Natural stone, Autoclaved aerated concrete
- Lightweight concrete, Standard concrete
- Asphalt, Concrete, Composite surfaces
- Fencing, Ground excavation, Rock breaking
- Ladles, Converter mouths, Kilns

WHERE **EXPERIENCE COUNTS**

More mounting options - less maintenance

The unique mono-block design is a result of years of engineering refinement and field experience. Two moving parts simplifies the breaker operation and reduces the chance of downtime. The advanced hydraulic circuit provides increased flow to the valve and piston, resulting in faster cycle times, increased rod penetration and more productivity per hour than on previous models. There are no through bolts to constantly torque or replace and the front wear bushing is easily replaced so your breaker is always in perfect working condition. The wider oil flow range is an example of the breakers superior design, allowing for faster striking speeds and the ability to be used on a wider range of carriers. The nitrogen charged back head increases the impact energy maximizing breaker production.

In the rare event that maintenance is needed, the Fx Series has been designed with replaceable cylinder liners saving maintenance cost and downtime.

Due to a small footprint, these breakers are ideal for use in tight work envelopes, pavement, driveway removal or any other demolition task. The Fx25 is available for use on mini-excavators. Mounting options are endless and can accommodate any carrier, or a combination of carriers or specific applications.



FX25

		FX25
Operating weight, pin and bush ¹⁾	kg	101
Operating weight, ¹⁾ S and XS ²⁾	kg	112
Height with rod, pin and bush	mm	1030
Height with rod, FT	mm	939
Height with rod, S	mm	961
Height with rod, XS	mm	1015
Operating pressure	min	MPa 10
	max	14
Oil flow	min	l/min 18
	max	32
Impact rate (frequency)	min	bpm 600
	max	1500
Rod diameter Ø	mm	45
Effective rod length	mm	293
Weight rod (standard)	kg	5
Hose inner dia Ø Press. Return	mm	12
Base machine weight	ton	1,0 - 2,5

¹⁾ Operating weight with top bracket, ²⁾ S and XS Silent Version = Sound and vibration damping

Specifications subject to change without notice

CAPABILITIES

- Overburden removal Bench, road & ramp levelling
- Brickwork, Natural stone, Autoclaved aerated concrete
- Lightweight concrete, Standard concrete
- Asphalt, Concrete, Composite surfaces
- Fencing, Ground excavation, Rock breaking
- Ladles, Converter mouths, Kilns

TYPE OF ROD

- Flat rod
- Moil point rod
- Wedge point rod
- Asphalt spad rod
- Wide rod
- Ball point rod



SOUND PRESSURE

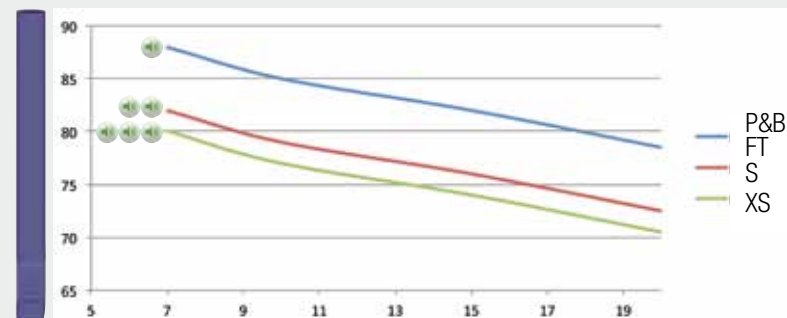

P&B



FT



S



XS

More mounting options - less maintenance

The unique mono-block design is a result of years of engineering refinement and field experience. Two moving parts simplifies the breaker operation and reduces the chance of downtime. The advanced hydraulic circuit provides increased flow to the valve and piston, resulting in faster cycle times, increased tool penetration and more productivity per hour than on previous models. There are no through bolts to constantly torque or replace and the front wear bushing is easily replaced so your breaker is always in perfect working condition. The wider oil flow range is an example of the hammers superior design, allowing for faster striking speeds and the ability to be used on a wider range of carriers. The nitrogen charged back head increases the impact energy maximizing breaker production.

In the rare event that maintenance is needed, the Fx Series has been designed with replaceable cylinder liners saving maintenance cost and downtime.

Due to a small footprint, these breakers are ideal for use in tight work envelopes, pavements, driveway removal or any other demolition task. The Fx35 is available for use on mini-excavators, compact utility loaders and skid steer loaders. Mounting options are endless and can accommodate any carrier, or a combination of carriers or specific applications.



FX35

		FX35	
Operating weight, pin and bush ¹⁾	kg	146	
Operating weight, ¹⁾ S and XS ²⁾	kg	157	
Height with rod, pin and bush	mm	1172	
Height with rod, FT	mm	1060	
Height with rod, S	mm	1062	
Height with rod, XS	mm	1116	
Operating pressure	min	MPa	12
	max		16
Oil flow	min	l/min	24
	max		42
Impact rate (frequency)	min	bpm	600
	max		1300
Rod diameter Ø	mm	52	
Effective rod length	mm	322	
Weight rod (standard)	kg	8	
Hose inner dia Ø Press. Return	mm	12	
Base machine weight	ton	1,5 - 4,0	

¹⁾ Operating weight with top bracket, ²⁾ S and XS Silent Version = Sound and vibration damping

Specifications subject to change without notice

CAPABILITIES

- Overburden removal Bench, road & ramp levelling
- Brickwork, Natural stone, Autoclaved aerated concrete
- Lightweight concrete, Standard concrete
- Asphalt, Concrete, Composite surfaces
- Fencing, Ground excavation, Rock breaking
- Ladles, Converter mouths, Kilns

TYPE OF ROD

- Flat rod
- Moil point rod
- Wedge point rod
- Asphalt spad rod
- Wide rod
- Ball point rod



SOUND PRESSURE

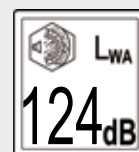
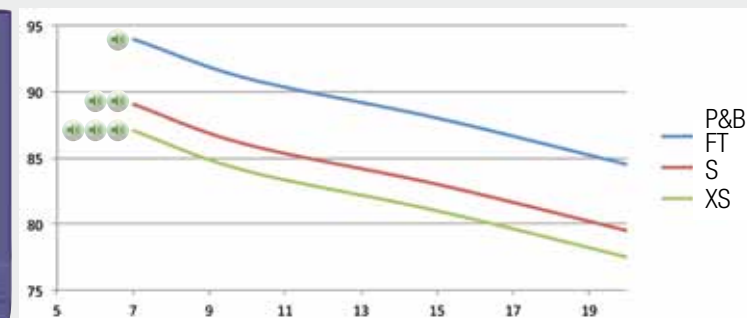

P&B

FT

S

XS

WHERE **EXPERIENCE COUNTS**

More mounting options - less maintenance

The unique mono-block design is a result of years of engineering refinement and field experience. Two moving parts simplifies the breaker operation and reduces the chance of downtime. The advanced hydraulic circuit provides increased flow to the valve and piston, resulting in faster cycle times, increased tool penetration and more productivity per hour than on previous models. There are no through bolts to constantly torque or replace and the front wear bushing is easily replaced so your breaker is always in perfect working condition. The wider oil flow range is an example of the hammers superior design, allowing for faster striking speeds and the ability to be used on a wider range of carriers. The nitrogen charged back head increases the impact energy maximizing breaker production.

In the rare event that maintenance is needed, the Fx Series has been designed with replaceable cylinder liners saving maintenance cost and downtime.

Due to a small footprint, these breakers are ideal for use in tight work envelopes, pavements, driveway removal or any other demolition task. The Fx45 is available for use on mini-excavators, compact utility loaders and skid steer loaders. Mounting options are endless and can accommodate any carrier, or a combination of carriers or specific applications.



FX45

		FX45	
Operating weight, pin and bush ¹⁾	kg	187	
Operating weight, ¹⁾ S and XS ²⁾	kg	208	
Height with rod, pin and bush	mm	1285	
Height with rod, FT	mm	1167	
Height with rod, S	mm	1173	
Height with rod, XS	mm	1227	
Operating pressure	min	MPa	12
	max		16
Oil flow	min	l/min	30
	max		56
Impact rate (frequency)	min	bpm	600
	max		1100
Rod diameter Ø	mm	60	
Effective rod length	mm	355	
Weight rod (standard)	kg	11	
Hose inner dia Ø Press. Return	mm	12	
Base machine weight	ton	2,5 - 5,5	

¹⁾ Operating weight with top bracket, ²⁾ S and XS Silent Version = Sound and vibration damping

Specifications subject to change without notice

CAPABILITIES

- Overburden removal Bench, road & ramp levelling
- Brickwork, Natural stone, Autoclaved aerated concrete
- Lightweight concrete, Standard concrete
- Asphalt, Concrete, Composite surfaces
- Fencing, Ground excavation, Rock breaking
- Ladles, Converter mouths, Kilns

TYPE OF ROD

- Flat rod
- Moil point rod
- Wedge point rod
- Asphalt spad rod
- Wide rod
- Ball point rod



SOUND PRESSURE

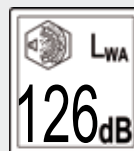
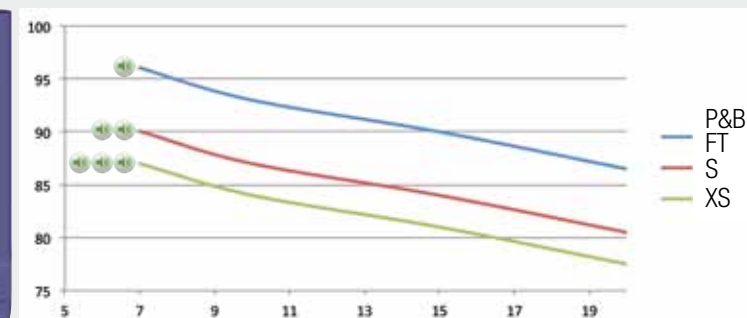

P&B



FT



S



XS

WHERE **EXPERIENCE COUNTS**

More mounting options - less maintenance

The unique mono-block design is a result of years of engineering refinement and field experience. Two moving parts simplifies the breaker operation and reduces the chance of downtime. The advanced hydraulic circuit provides increased flow to the valve and piston, resulting in faster cycle times, increased tool penetration and more productivity per hour than on previous models. There are no through bolts to constantly torque or replace and the front wear bushing is easily replaced so your breaker is always in perfect working condition. The wider oil flow range is an example of the hammers superior design, allowing for faster striking speeds and the ability to be used on a wider range of carriers. The nitrogen charged back head increases the impact energy maximizing breaker production.

In the rare event that maintenance is needed, the Fx Series has been designed with replaceable cylinder liners saving maintenance cost and downtime.

Due to a small footprint, these breakers are ideal for use in tight work envelopes, pavements, driveway removal or any other demolition task. The Fx55 is available for use on mini-excavators, compact utility loaders and skid steer loaders. Mounting options are endless and can accommodate any carrier, or a combination of carriers or specific applications.



FX55

		FX55
Operating weight, pin and bush ¹⁾	kg	245
Operating weight, ¹⁾ S and XS ²⁾	kg	280
Height with rod, pin and bush	mm	1388
Height with rod, FT	mm	1264
Height with rod, S	mm	1276
Height with rod, XS	mm	1330
Operating pressure	min	MPa 12
	max	16
Oil flow	min	l/min 40
	max	72
Impact rate (frequency)	min	bpm 500
	max	1000
Rod diameter Ø	mm	68
Effective rod length	mm	378
Weight rod (standard)	kg	15
Hose inner dia Ø Press. Return	mm	12
Base machine weight	ton	4,0 - 7,0

¹⁾ Operating weight with top bracket, ²⁾ S and XS Silent Version = Sound and vibration damping

Specifications subject to change without notice

CAPABILITIES

- Overburden removal Bench, road & ramp levelling
- Brickwork, Natural stone, Autoclaved aerated concrete
- Lightweight concrete, Standard concrete
- Asphalt, Concrete, Composite surfaces
- Fencing, Ground excavation, Rock breaking
- Ladles, Converter mouths, Kilns

TYPE OF ROD

- Flat rod
- Moil point rod
- Wedge point rod
- Asphalt spad rod
- Wide rod
- Ball point rod



SOUND PRESSURE

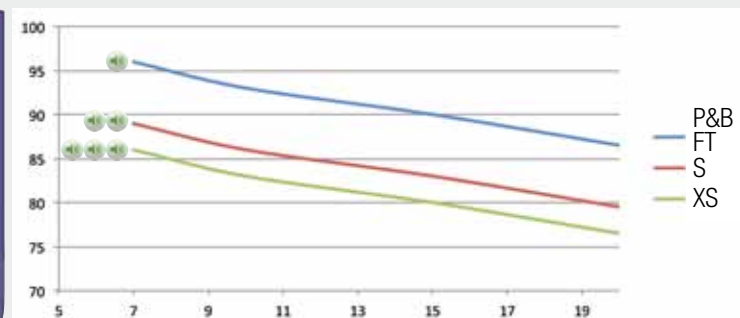

P&B



FT



S



XS

WHERE **EXPERIENCE COUNTS**

FIND THE MEDIUM SERIES BREAKER THAT SUITS YOU



MEDIUM HYDRAULIC BREAKERS



	Job	Specification	
Construction	Gardening & Landscaping	Fencing, ground excavation, rock breaking	●
	Earthworks	Trenching, Pit building, ground excavation	●
	Dredging	Canal deepening & extension Dock deepening & extension	●
	Tunnelling	Tunnel driving, roof, face & rib scaling Floor levelling	●
	Foundation works	Ground levelling	●
	Foundation	Foundation pile driving	●
Demolition & renovation	Masonry structures	Brickwork, Natural stone Autoclaved aerated concrete	●
	Concrete structures	Lightweight concrete, Standard concrete Heavyweight concrete	●
	Pavements	Asphalt, concrete, composite surfaces	●
	Composite steel & concrete structures	Steel reinforced concrete, pre-stressed concrete, Fibre-reinforced concrete	●
Mining & quarrying	Preliminary works	Overburden removal, bench, road & ramp levelling, roof, face & rib scaling	●
	Secondary breaking	Boulder reduction in rock piles, removing blockages at crushing systems	●
	Primary rock breaking	Selective rock breaking, blast-free mining	●
Metallurgical industry	Cleaning & de-bricking	Ladles, converter mouths, kilns	●
	Slag recycling	Boulder reduction in slag heaps, removing blockages at crushing systems	●

● Optimal ● Suitable

WHERE **EXPERIENCE COUNTS**

F6 F9-THE SPECIALISTS IN MIDI EXCAVATORS AND BACKHOE LOADERS

Behind their simple exterior FRD breakers hide many years' of experience, careful learning and intelligent design. There are hundreds of reasons to let FRD products do your work, here are just some of them.

HIGH POWER/WEIGHT RATIO

The use of high quality materials and highest quality production process results in a breaker body with less weight, with higher output/performance.

MINIMUM MOVING PARTS

The fewer parts move, the fewer parts that will wear. This reduces maintenance cost and downtime.

ADJUSTABLE STORKE VALVE

The breaker can be adjusted to any specification of the carrying excavator and to each required optimal working condition.

HIGH RELIABILITY

The use of the best quality materials and the highest quality standard in production securely creates a product that will work longer and is more efficient.

LOW MAINTENANCE

High quality materials give longer lifetime to each part, which drastically reduce the total maintenance cost.

LOWEST LIFETIME COST

Over long periods the advantages of less downtime and fewer parts to replace results in a cost per year which are the lowest in the market.

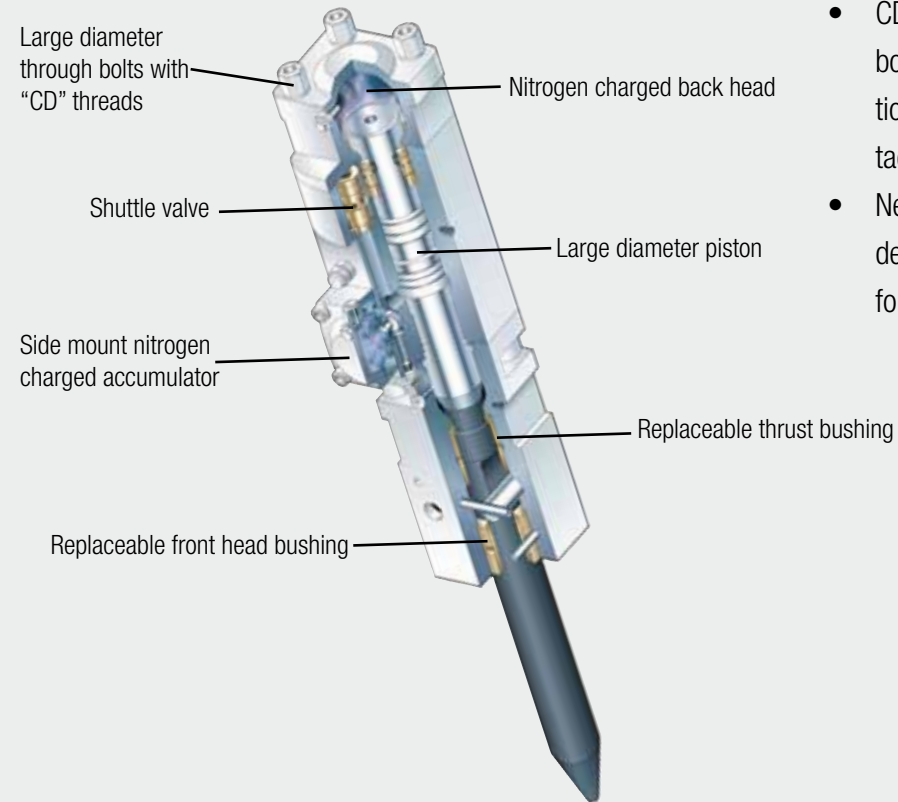

Features and Benefits:

- Nitrogen charged back head for superior energy transfer
- Large diameter piston for increase in impact energy
- CD designed threads on thru-bolt provide even load distribution and greater surface contact between the nut and bolt
- New front head design includes replaceable thrust bushing for added service life

MEDIUM HYDRAULIC BREAKERS

BHL**FLATTOP****SILENCE****SILENCE**

For each request, the optimum breaker frame.

FRD in the medium series offers up to three different breaker frames.

BHL

The easiest way to fix a hydraulic breaker on a backhoe loader. FRD has for each backhoe the right setting.

Flat top

The cheapest solution is to attach the breaker with different systems. With the FT framework easy to grow, you have the base mounting plates for quick-change systems of all kinds

Silence

Noise reduction is required in the workplace; you have the beginning of the Silence part of our offered possibilities. The frame is up to 6 DbA quieter than the standard frame

Features and Benefits:

- We provide for each backhoe the right frame

WHERE **EXPERIENCE COUNTS**

F6BHL THE SPECIALISTS IN BACKHOE LOADERS

Versatility and power are the benefits of the F6BHL. The F6 is available with a variation of BHL frames and pin and bushing kits that allow it to be fitted on any backhoe loader available on the market. This design ensures ideal breaker/arm positioning for optimal performance and also increases tucking under capabilities for on the road transport ensuring the backhoe loader conforms to relevant road regulations. These mid-size hammers are engineered with a higher back head pressure and larger pistons for an increase in impact energy of 20-30%.



F6 BHL

		F6BHL	
Operating weight, pin and bush ¹⁾	kg	365	
Operating weight, NL ²⁾	kg	350	
Height with rod, pin and bush	mm	1450	
Height with rod, LN	mm	1400	
Operating pressure	min	MPa	10
	max		16
Oil flow	min	l/min	50
	max		150
Impact rate (frequency)	min	bpm	650
	max		1600
Rod diameter Ø	mm	75	
Effective rod length	mm	450	
Weight rod (standard)	kg	21,5	
Hose inner dia Ø Press. Return	mm	12	
Base machine weight	ton	3,5 - 10	

TYPE OF ROD

- Flat rod
- Moil point rod
- Wedge point rod
- Asphalt spad rod
- Wide rod
- Ball point rod

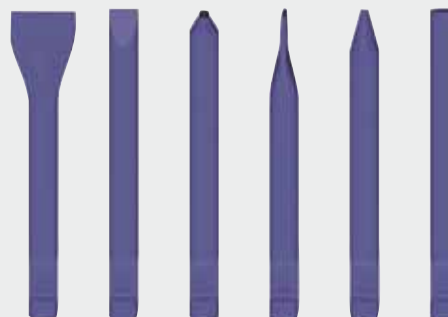

SOUND PRESSURE

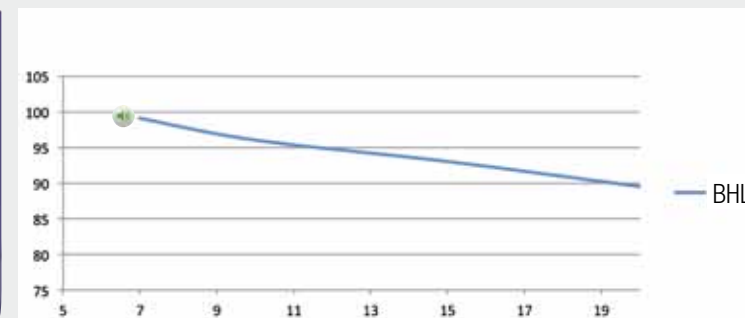

¹⁾ Operating weight with top bracket. ²⁾ LN Silent Version = Sound and vibration damping

Specifications subject to change without notice

CAPABILITIES

- Overburden removal Bench, road & ramp levelling
- Brickwork, Natural stone, Autoclaved aerated concrete
- Lightweight concrete, Standard concrete
- Asphalt, Concrete, Composite surfaces
- Fencing, Ground excavation, Rock breaking
- Ladles, Converter mouths, Kilns



BHL

F6 THE SPECIALISTS IN MIDI EXCAVATORS

Versatility and power are the benefits of the F6. These breakers are available with FRD's FT side plate mounting system and LN low noise frame for each mounting plates.

The F6 LN is the popular version to accommodate work environments that demand a reduced noise level. These midsize hammers are engineered with a higher back head pressure and larger pistons for an increase in impact energy of 20-30%.



F6

		F6	
Operating weight, FT ¹⁾	kg	365	
Operating weight, LN ²⁾	kg	350	
Height with rod, FT	mm	1450	
Height with rod, LN	mm	1400	
Operating pressure	min	MPa	10
	max		16
Oil flow	min	l/min	50
	max		150
Impact rate	min	bpm	650
	max		1600
Impact energy	max	joules	884
Rod diameter Ø	mm	75	
Effective length rod	mm	450	
Weight rod	kg	21,5	
Hose inner dia Ø Press. Return	mm	12	
Base machine weight	ton	5,0 - 9,0	

¹⁾ Operating weight with top bracket. ²⁾ LN Silent Version = Sound and vibration damping

Specifications subject to change without notice.

TYPE OF ROD

- Flat rod
- Moil point rod
- Wedge point rod
- Asphalt spad rod
- Wide rod
- Ball point rod

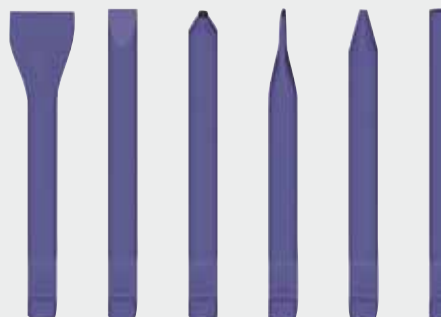

SOUND PRESSURE

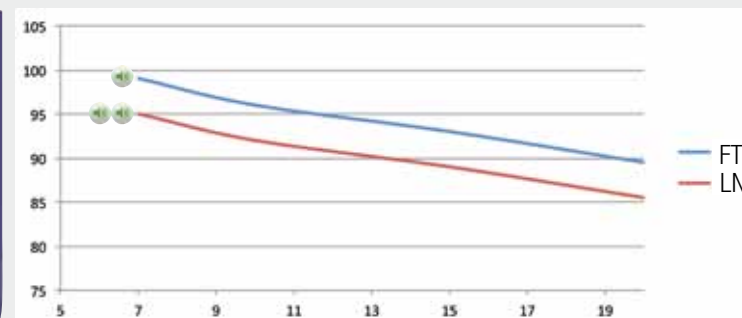

FT



LN

CAPABILITIES

- Overburden removal Bench, road & ramp levelling
- Brickwork, Natural stone, Autoclaved aerated concrete
- Lightweight concrete, Standard concrete
- Asphalt, Concrete, Composite surfaces
- Fencing, Ground excavation, Rock breaking
- Ladles, Converter mouths, Kilns

WHERE **EXPERIENCE COUNTS**

F9LN THE SPECIALISTS IN MIDI EXCAVATORS

Versatility and power are the benefits of the F9. These breakers are available with FRD's LN low noise frame for each mounting plates. The F9 LN is the popular version to accommodate work environments that demand a reduced noise level. These midsize hammers are engineered with a higher back head pressure and larger pistons for an increase in impact energy of 20-30%.



F9 LN

		F9	
Operating weight, FT ¹⁾	kg		
Operating weight, ¹⁾ LN ²⁾	kg	535	
Height with rod, FT	mm		
Height with rod, LN	mm	1595	
Operating pressure	min	MPa	12
	max		17
Oil flow	min	l/min	45
	max		150
Impact rate	min	bpm	400
	max		1400
Impact energy	max	joules	1305
Rod diameter Ø	mm	90	
Effective length rod	mm	500	
Weight rod	kg	35,5	
Hose inner dia Ø Press. Return	mm	19	
Base machine weight	ton	6 - 12	

¹⁾ Operating weight with top bracket. ²⁾ LN Silent Version = Sound and vibration damping

Specifications subject to change without notice.

TYPE OF ROD

- Flat rod
- Moil point rod
- Wedge point rod
- Asyphalt spad rod
- Wide rod
- Ball point rod



SOUND PRESSURE

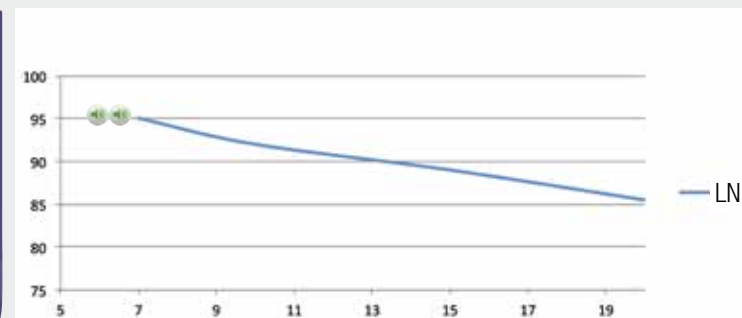

CAPABILITIES

- Overburden removal Bench, road & ramp levelling
- Brickwork, Natural stone, Autoclaved aerated concrete
- Lightweight concrete, Standard concrete
- Asphalt, Concrete, Composite surfaces
- Fencing, Ground excavation, Rock breaking
- Ladles, Converter mouths, Kilns

WHERE **EXPERIENCE COUNTS**

FIND THE LARGE SERIES BREAKER THAT SUITS YOU

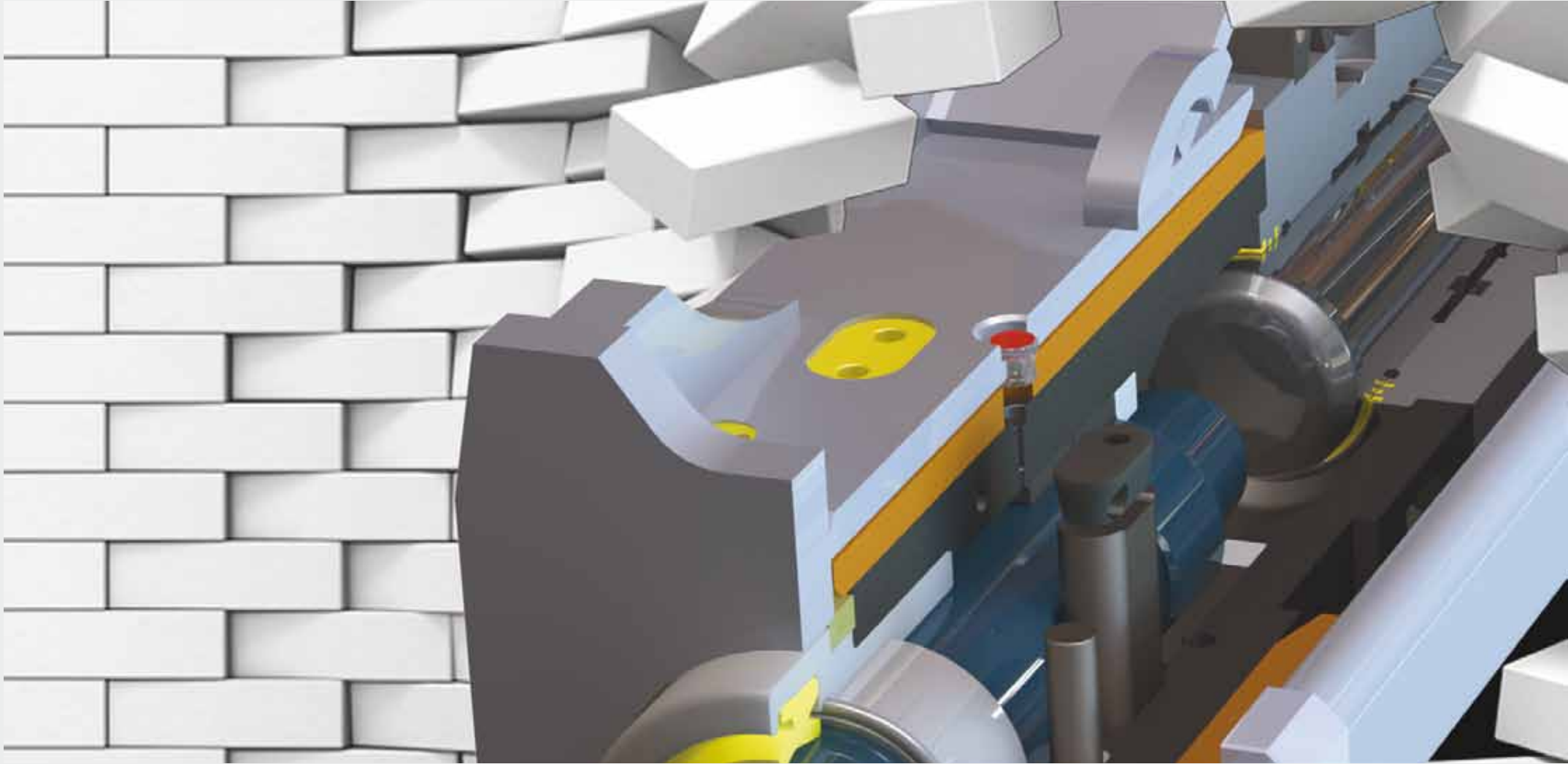

LARGE HYDRAULIC BREAKERS



	Job	Specification	
Construction	Gardening & Landscaping	Fencing, Ground excavation, Rock breaking	–
	Earthworks	Trenching, Pit building, Ground excavation	●
	Dredging	Canal deepening & extension Dock deepening & extension	●
	Tunnelling	Tunnel driving, Roof, face & rib scaling Floor levelling	●
	Foundation works	Ground levelling	●
	Foundation	Foundation pile driving	●
Demolition & renovation	Masonry structures	Brickwork, Natural stone Autoclaved aerated concrete	–
	Concrete structures	Lightweight concrete, Standard concrete Heavyweight concrete	●
	Pavements	Asphalt, Concrete, Composite surfaces	●
	Composite steel & concrete structures	Steel-reinforced concrete, Prestressed concrete, Fibre-reinforced concrete	●
Mining & quarrying	Preliminary works	Overburden removal, Bench, road & ramp levelling, Roof, face & rib scaling	●
	Secondary breaking	Boulder reduction in rock pile, Removing blockages at crushing systems	●
	Primary rock breaking	Selective rock breaking, Blast-free mining	●
Metallurgical industry	Cleaning & debricking	Ladles, Converter mouths, Kilns	–
	Slag recycling	Boulder reduction in slag heap, Removing blockages at crushing systems	●

● Optimal ● Suitable

WHERE **EXPERIENCE COUNTS**

F12 F100-The specialists in excavation

Today Furukawa Rock Drill is a worldwide specialist in demolition and rock excavation with a wide range of carefully designed and robust breakers, attachments and crawler drills. Since its founding in 1875 Furukawa Rock Drill has specialized in the demolition and rock excavation field. Their over one hundred and thirty years experience has assured the company of an excellent reputation. All products are manufactured in the company's own plants using only the best materials under the highest quality control.

Features and Benefits:

- Dust intake prevention system for trouble-free operation in severe environments
- Innovative power control center for centralized operation of the grease ports, stroke adjuster, remote control, valve adjustment and safety valve
- CD designed threads on the through bolt provide even load distribution and greater surface contact between the nut and bolt
- Two years warranty on the front head, back head, piston & cylinder on all large series breakers

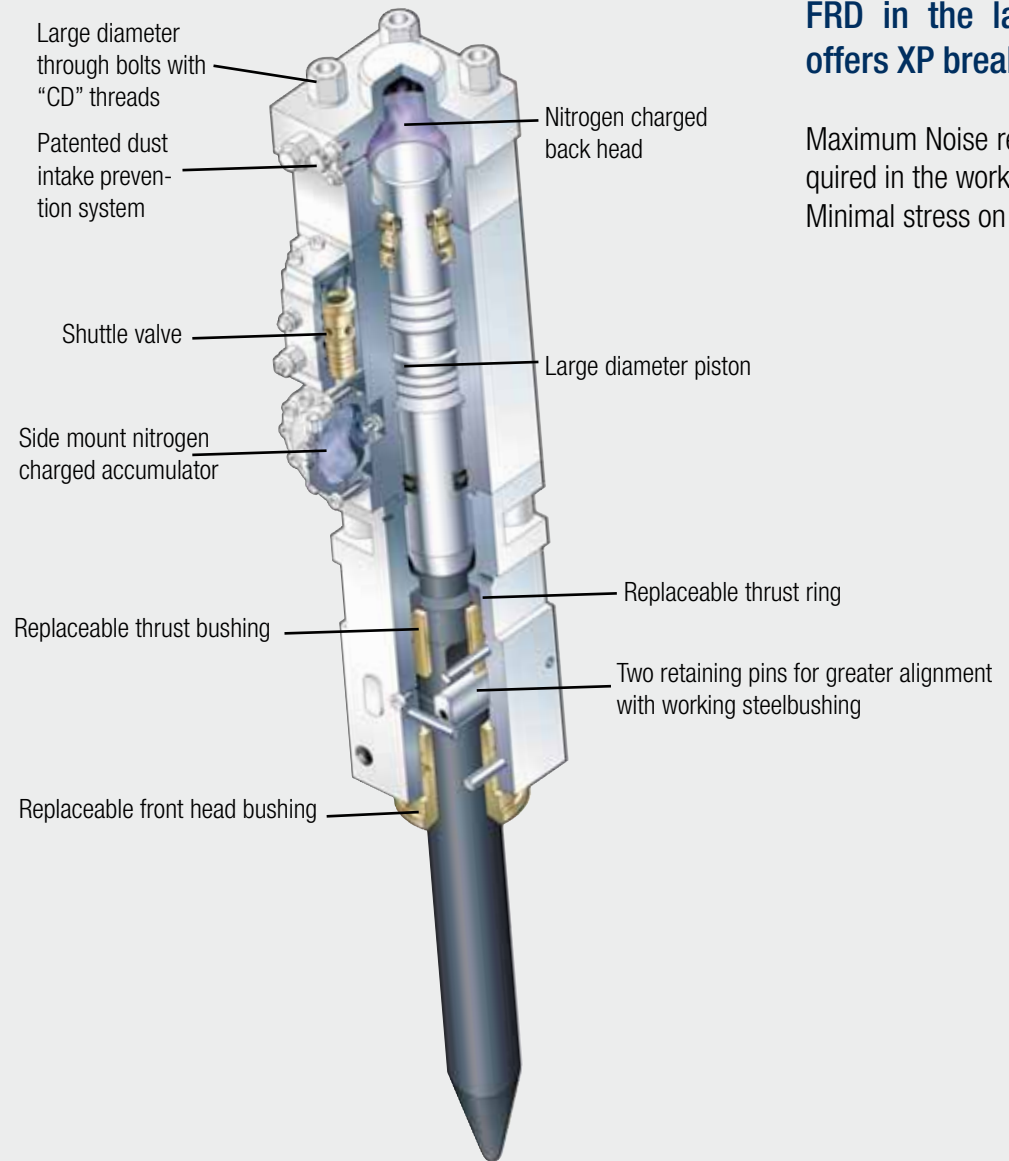

FRD in the large series offers XP breaker frames.

Maximum Noise reduction is required in the workplace.
Minimal stress on the excavator.

LARGE HYDRAULIC BREAKERS



XP breaker power control center.

For each work, the best performance. The power control center regulates all operating situations:

- Operating Pressure
- Impact energy
- Impact rate
- Central lubrication point
- Remote control system

Safety devices:

- Safety valve for pressure spikes
- Anti idle bow

FRD guarantee:

Maximum power with any excavator.

Customizable for the toughest jobs.

Maximum protection of all wearing parts.

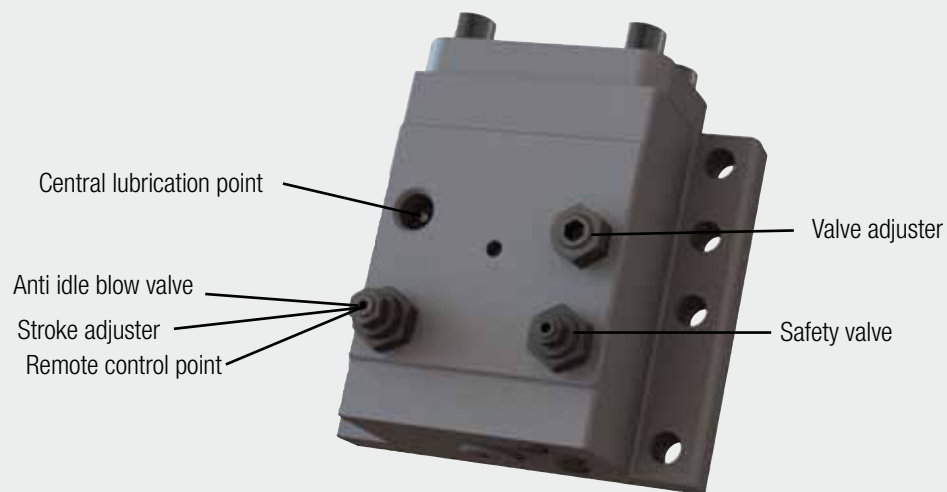

HIGH POWER/WEIGHT RATIO

The use of high quality materials and the highest quality production process results in a breaker body with less weight, with higher output/performance.

MINIMUM MOVING PARTS

The fewer parts move, the fewer parts will wear. This reduces maintenance cost and downtime.

ADJUSTABLE VALVE

The breaker can be adjusted to any specification of the carrying excavator and to each required optimal working condition.

HIGH RELIABILITY

The use of the best quality materials and the highest quality standard in production creates a product that will work longer and is more efficient.

LOW MAINTENANCE

High quality materials give a longer lifetime to each part, which drastically reduce the total maintenance cost.

LOWEST LIFETIME COST

Over long periods the advantages of less downtime and fewer parts to replace results in a cost per year, which are the lowest in the market.

FRD SENCIO THE NEW LUBRICATION CONCEPT

Sencio Lubrico large

The Central lubrication eliminates the regular manual greasing intervals during operation and provides an optimum level of lubrication. This FRD designed automatic lubrication system is on the excavator mounted and provides continuous adjustable greasing of the working tool guiding area. The filling level of the transparent container can be easily monitored from the excavator cabin and if required refilled within minutes.

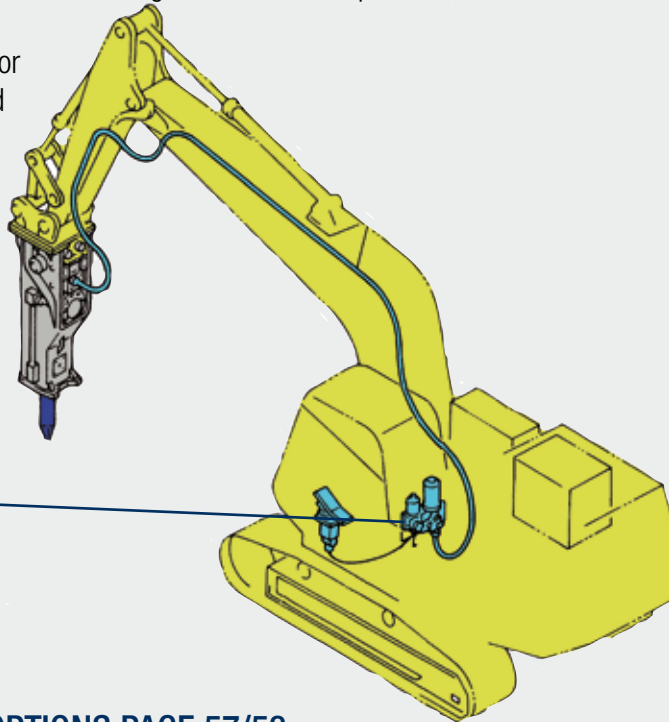

Sencio Lubrico motion

The new Central lubrication concept eliminates the regular manual greasing intervals during operation and provides an optimum level of lubrication. This FRD designed automatic lubrication system is directly breaker frame mounted without external hose guiding and provides continuous adjustable greasing of the working tool guiding area. The filling level of the transparent screw cartridge can be easily monitored from the excavator cabin and if required exchanged within minutes.

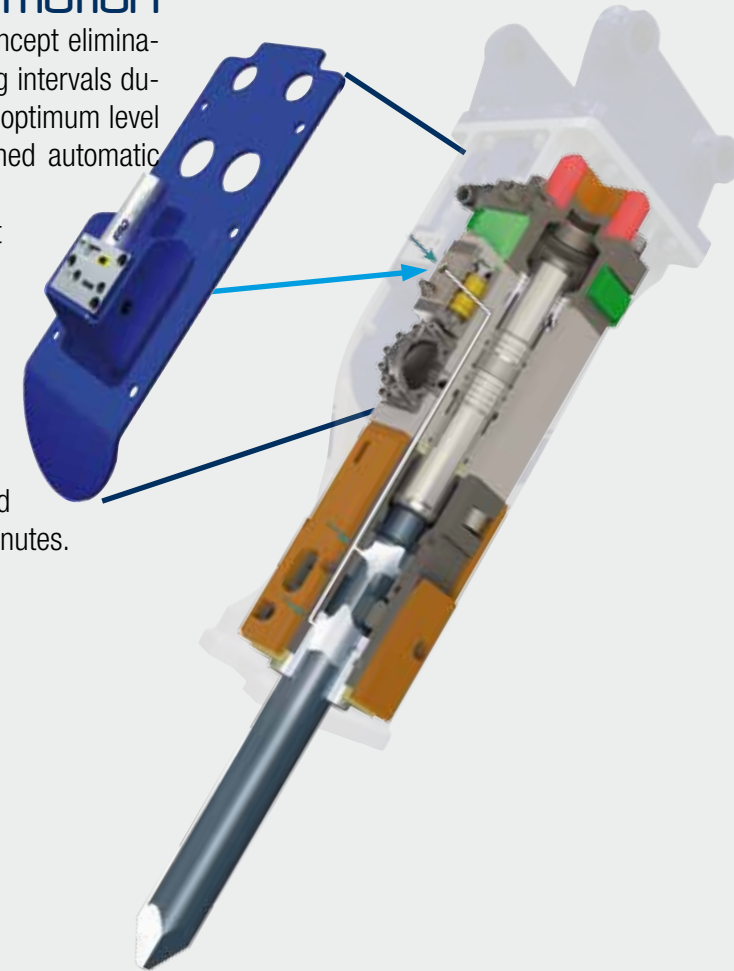

ATTACHMENTS AND OPTIONS PAGE 57/58

SENCIO REDUCING MAINTENANCE COSTS

World first In environmental protection

Sencio Blue

Sencio Blue-Rod grease is a lithium-complex soap grease based on mineral oil. It contains a solid lubricant combination of copper / graphite and molybdenum disulphide (MoS₂). It has good separation efficiency and reduces wear at high surface loads and temperatures up to 1100 °C



Sencio-Rodgrease is characterized by:

- High load carrying capacity
- Good corrosion protection
- Good water resistance
- Good separation efficiency
- Wear reduction
- Oxidation resistance

Sencio White

Sencio White-BIO-Rod grease based on selected, rapidly biodegradable, synthetic esters, which give a very stable lithium saponified grease. By the addition of selected white solid lubricants, a high value and a high VKA four ball wear load, a high load carrying capacity was achieved. Sencio-BIO-Rodgrease has been awarded the European Ecolabel, registration no. DE/027/089.



DE/027/089



„If a drop of oil makes 25 liters of water unusable, what will happen with grease in the ground?“

F12 - F70 XP MULTI- AND SELF CLEANING SYSTEM

The FRD MULTI- AND SELF CLEANING SYSTEM which comes as a standard in the XP series is the smartest way to operate your hydraulic breaker in various jobsite situations. The FRD MULTI- AND SELF CLEANING SYSTEM makes it possible to protect the vital parts of the breaker body and to extend their life.

The XP series gives you the unified system without big modifications.

Features and Benefits:

- Dust protection for the Piston, Rod and wear-bushings
- Compressed Air Connection for underwater operation
- Compressed Air Connection for Tunnel and Scaling operations
- Cooling air connection for hot environment operations.

ATTACHMENTS AND OPTIONS PAGE 57/58

XP CLEANING SYSTEMS

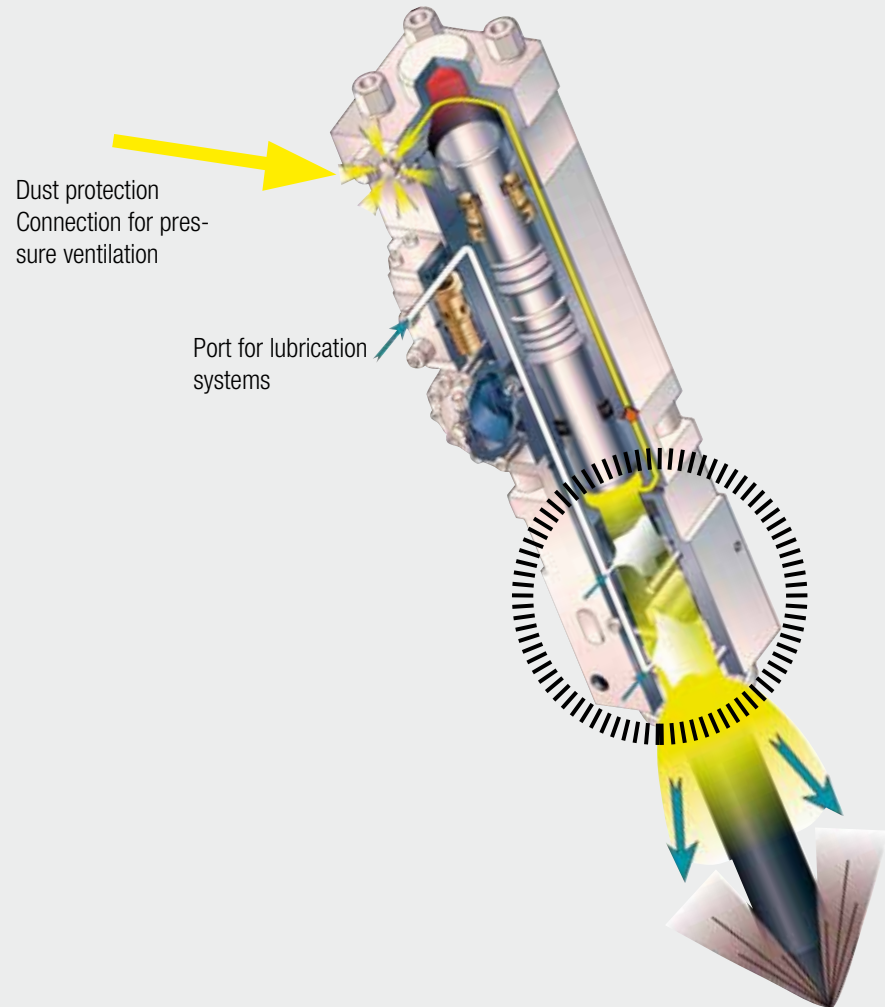



WHERE **EXPERIENCE COUNTS**

F12XP THE SPECIALISTS IN WHEEL AND MID-SIZE EXCAVATORS

The F12XP is a mid-size hammer designed for use on excavators and pedestal booms. Operators appreciate performance features such as a stroke control, which lengthens or shortens the stroke and adapts the impact energy to the material being broken. Internal maintenance is greatly reduced due to the patented dust intake prevention system. This system prevents dust from being drawn into the front head on the upstroke of the piston protecting critical wear Components. The F12XP is also designed to accommodate automatic lubrication systems for quick daily maintenance.

CAPABILITIES

- Overburden removal, bench, road & ramp levelling
 - Boulder reduction in rock piles
 - Lightweight concrete, standard concrete
 - Steel-reinforced concrete, pre-stressed concrete, fibre-reinforced concrete
 - Asphalt, concrete, composite surfaces
 - Trenching, pit building, ground excavation
 - Tunnel driving, roof, face & rib scaling, floor levelling
 - Boulder reduction in slag heaps
- Only with FRD special equipment
- Roof clearing
 - Bench levelling
 - Removing encrustations
 - Breaking out ladles and molds

ATTACHMENTS AND OPTIONS PAGE 57/58

F12XP



SOUND PRESSURE

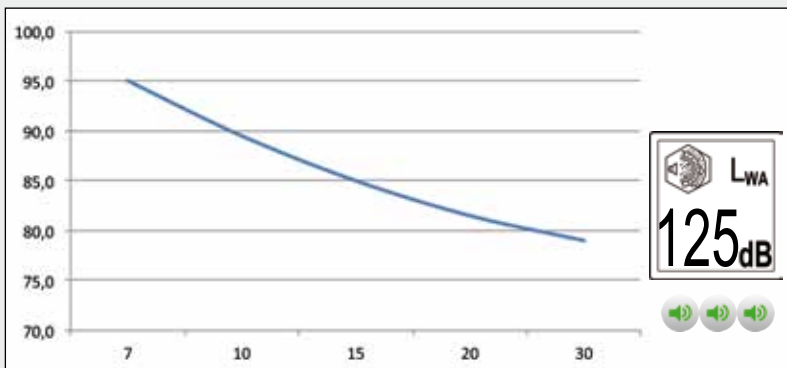

PRODUCTIVITY

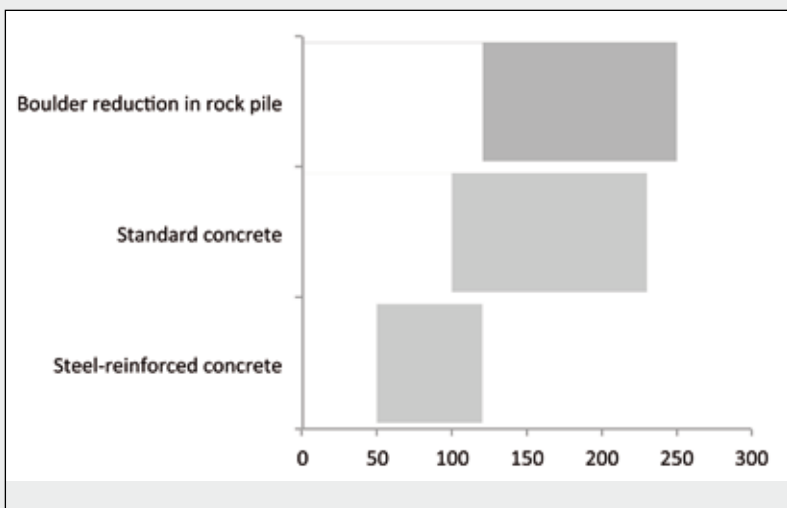

TYPE OF ROD

- Flat rod
- Moil point rod
- Wedge point rod
- Ball point rod



Specifications	F12XP	
Operating weight, ¹⁾ XP	kg	880
Height with rod,	mm	2100
Operating pressure	min MPa	16
	max	18
Oil flow	min l/min	100
	max	130
Impact rate	min bpm	450
	max	900
Impact energy	max joules	2320
Rod diameter Ø	mm	105
Effective length rod	mm	650
Weight rod	kg	68
Hose inner dia Ø Press. Return	mm	19
Base machine weight	ton	10 - 16

¹⁾ Operating weight with top bracket. XP Silent Version = Sound and vibration damping

Specifications subject to change without notice



WHERE **EXPERIENCE** COUNTS

F19XP THE SPECIALISTS IN WHEEL AND MID-SIZE EXCAVATORS

The F19XP is a mid-size hammer designed for use on excavators and pedestal booms. Operators appreciate performance features such as a stroke control, which lengthens or shortens the stroke and adapts the impact energy to the material being broken. Internal maintenance is greatly reduced due to the patented dust intake prevention system. This system prevents dust from being drawn into the front head on the upstroke of the piston protecting critical wear Components. The F19XP is also designed to accommodate automatic lubrication systems for quick daily maintenance.

CAPABILITIES

- Overburden removal, bench, road & ramp levelling
- Boulder reduction in rock piles
- Lightweight concrete, standard concrete
- Steel-reinforced concrete, pre-stressed concrete, fibre-reinforced concrete
- Asphalt, concrete, composite surfaces
- Trenching, pit building, ground excavation
- Tunnel driving, roof, face & rib scaling, floor levelling
- Boulder reduction in slag heaps

Only with FRD special equipment

- Roof clearing
- Bench levelling
- Removing encrustations
- Breaking out ladles and molds
- Underwater Demolition, Deepening shipping channels

ATTACHMENTS AND OPTIONS PAGE 57/58

F19XP



SOUND PRESSURE

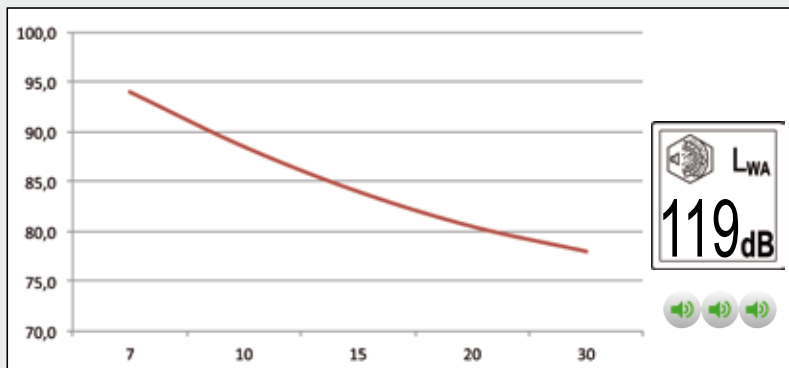

PRODUCTIVITY

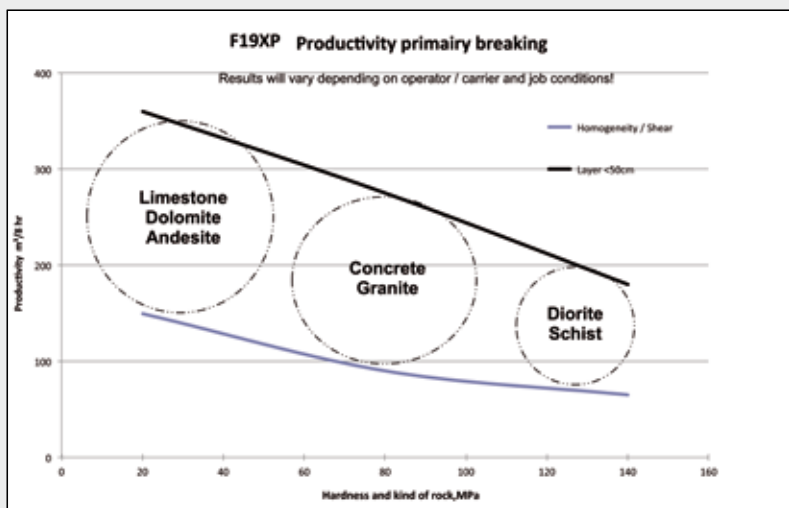

TYPE OF ROD

- Flat rod
- Moil point rod
- Wedge point rod
- Ball point rod



Specifications	F19XP	
Operating weight, ¹⁾ XP	kg	1260
Height with rod,	mm	2270
Operating pressure	min Mpa	16
	max	18
Oil flow	min l/min	120
	max	155
Impact rate	min bpm	400
	max	750
Impact energy	max joules	35792
Rod diameter Ø	mm	120
Effective length rod	mm	700
Weight rod	kg	100
Hose inner dia Ø Press. Return	mm	25
Base machine weight	ton	12 - 19

¹⁾ Operating weight with top bracket. XP Silent Version = Sound and vibration damping

Specifications subject to change without notice



WHERE **EXPERIENCE COUNTS**

F22XP THE SPECIALISTS IN WHEEL AND MID-SIZE EXCAVATORS

The F22XP is the most popular in the F-Series line-up. Built to take the punishment operators demand, the F22XP is a breaker that can handle road removal, foundation demolition, and the extremes of quarry applications. And the one-piece enclosure reduces noise levels making it a perfect choice for reduced noise applications. A built-in hydraulic safety valve actuates when the carrier pressure exceeds the maximum limit. This eliminates the need for a costly relief valve in the hydraulic system of the carrier. A higher back head pressure and large piston diameter increase the impact energy by up to 20-30% over previous models.

CAPABILITIES

- Overburden removal, bench, road & ramp levelling
 - Boulder reduction in rock piles
 - Lightweight concrete, standard concrete
 - Steel-reinforced concrete, pre-stressed concrete, fibre-reinforced concrete
 - Asphalt, concrete, composite surfaces
 - Trenching, pit building, ground excavation
 - Tunnel driving, roof, face & rib scaling, floor levelling
 - Boulder reduction in slag heaps
- Only with FRD special equipment
 - Roof clearing
 - Bench levelling
 - Tunnel driving
 - Breaking up slag
 - Underwater Demolition, Deepening shipping channels

ATTACHMENTS AND OPTIONS PAGE 57/58

F22XP



SOUND PRESSURE

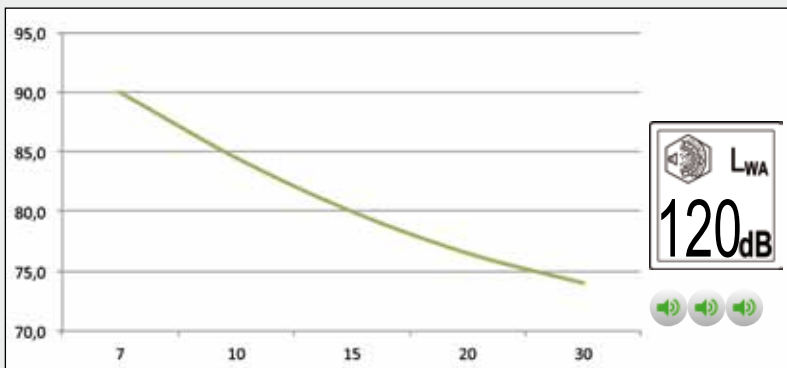

PRODUCTIVITY

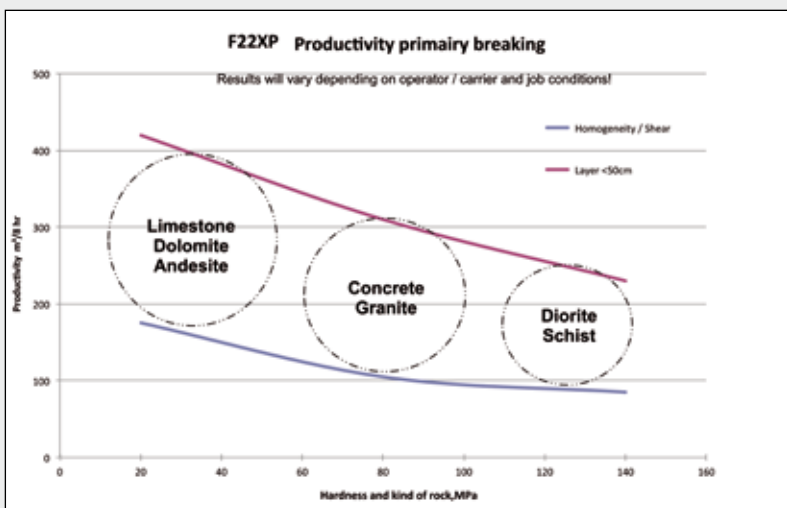

TYPE OF ROD

- Flat rod
- Moil point rod
- Wedge point rod
- Ball point rod



Specifications	F22XP	
Operating weight, ¹⁾ XP	kg	1650
Height with rod,	mm	2348
Operating pressure	min MPa	16
	max	18
Oil flow	min l/min	145
	max	180
Impact rate	min bpm	360
	max	700
Impact energy	max joules	4572
Rod diameter Ø	mm	135
Effective length rod	mm	725
Weight rod	kg	128
Hose inner dia Ø Press. Return	mm	25
Base machine weight	ton	16 - 25

¹⁾ Operating weight with top bracket. XP Silent Version = Sound and vibration damping

Specifications subject to change without notice



WHERE **EXPERIENCE COUNTS**

F27XP THE SPECIALISTS IN MID-SIZE EXCAVATORS

A mid-size breaker in the large F-series line-up, the F27XP is a brute among hammers. No job is too demanding, from the rigours of runway removal to the reduction of bridge pylons, the F27XP is at home, performing with reliable ease on a daily basis. All the features of the F-series are present in this breaker; a dust intake prevention system, unique greasing system for lubrication of the front head, increased back head pressure and large piston diameter for greater impact energy.

CAPABILITIES

- | | |
|---|--|
| <ul style="list-style-type: none"> • Overburden removal, bench, road & ramp levelling • Boulder reduction in rock piles, • Lightweight concrete, standard concrete • Steel-reinforced concrete, pre-stressed concrete, fibre-reinforced concrete • Asphalt, concrete, composite surfaces • Trenching, pit building, ground excavation • Tunnel driving, roof, face & rib scaling, floor levelling • Boulder reduction in slag heaps | <p>Only with FRD special equipment</p> <ul style="list-style-type: none"> • Roof clearing • Bench levelling • Removing encrustations • Breaking out ladles and molds • Underwater Demolition, Deepening shipping channels |
|---|--|

ATTACHMENTS AND OPTIONS PAGE 57/58

F27XP



SOUND PRESSURE

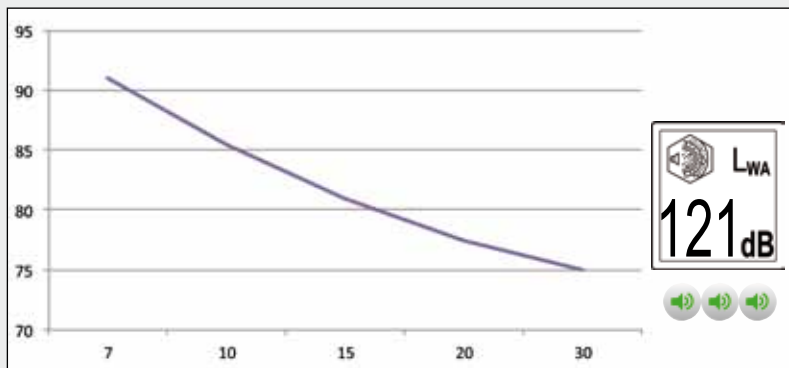

PRODUCTIVITY

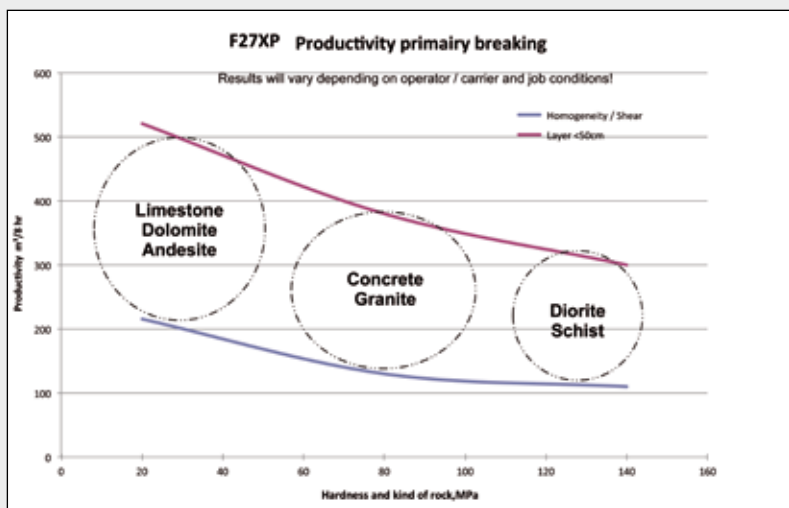

TYPE OF ROD

- Flat rod
- Moil point rod
- Wedge point rod
- Ball point rod



Specifications	F27XP	
Operating weight, ¹⁾ XP	kg	1805
Height with rod,	mm	2455
Operating pressure	min	MPa 16
	max	18
Oil flow	min	l/min 155
	max	190
Impact rate	min	bpm 340
	max	650
Impact energy	max	joules 5118
Rod diameter Ø	mm	140
Effective length rod	mm	750
Weight rod	kg	145
Hose inner dia Ø Press. Return	mm	25
Base machine weight	ton	20 - 30

¹⁾ Operating weight with top bracket. XP Silent Version = Sound and vibration damping

Specifications subject to change without notice



WHERE **EXPERIENCE** COUNTS

F35XP THE SPECIALISTS IN LARGE-SIZE EXCAVATORS

Designed for excavators in the 25 to 40 ton range, the F35XP is a hard hitting breaker that has no rivals. With years of research behind each hammer, it's no accident the F-series outperforms the competition. It starts from the inside out with a patented dust intake prevention system that keeps critical internal parts free from the damage dirt can cause, and continues with the hydraulic safety valve that actuates when the maximum hydraulic pressure is exceeded. We don't stop there, a larger piston diameter and increase in the back head pressure improves the breaker impact performance. An optional hi-lo speed control actuated from the cab matches the breaker and excavator to the application.

CAPABILITIES

- Secondary breaking
- Primary rock breaking
- Heavyweight concrete
- Steel-reinforced concrete
- Pre-stressed concrete
- Fibre-reinforced concrete
- Trenching
- Pit building
- Ground excavation
- Tunnel driving
- Roof, face & rib scaling
- Floor levelling
- Canal deepening & extension
- Dock deepening & extension
- Ground levelling
- Foundation pile driving

ATTACHMENTS AND OPTIONS PAGE 57/58

F35XP



SOUND PRESSURE

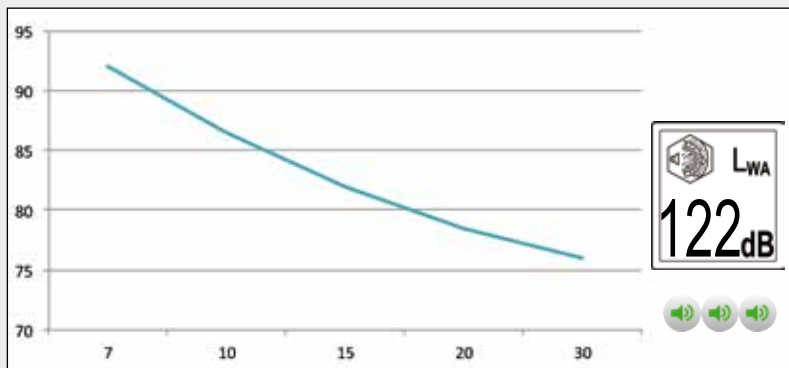

PRODUCTIVITY

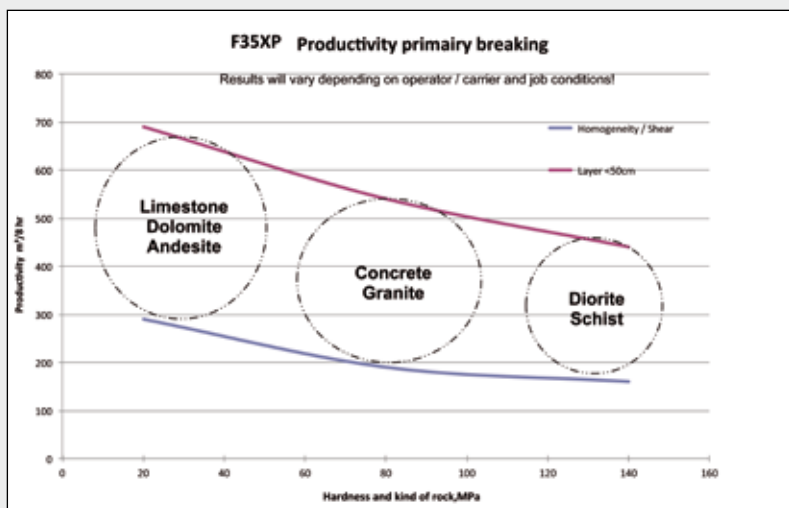

TYPE OF ROD

- Flat rod
- Moil point rod
- Wedge point rod
- Ball point rod



Specifications	F35XP	
Operating weight, ¹⁾ XP	kg	2385
Height with rod,	mm	2648
Operating pressure	min MPa	16
	max	18
Oil flow	min l/min	175
	max	220
Impact rate	min bpm	320
	max	600
Impact energy	max joules	6883
Rod diameter \varnothing	mm	150
Effective length rod	mm	775
Weight rod	kg	150
Hose inner dia \varnothing Press.Return	mm	25
Base machine weight	ton	25 - 40

¹⁾ Operating weight with top bracket. XP Silent Version = Sound and vibration damping

Specifications subject to change without notice



WHERE **EXPERIENCE** COUNTS

F45XP THE SPECIALISTS IN LARGE-SIZE EXCAVATORS

Excavators in the 30-50 ton class are the perfect match for this demolition machine. Whether you're breaking blue granite in Scandinavia or reducing oversize in quarries, the F45XP performs its job quietly and with ease. The unique one-piece enclosure and damper system reduces noise levels for use in noise sensitive environments. A higher back head pressure and larger piston diameter increases impact performance by 20% over previous models. We made greasing easy with a unique lubrication system for the front head and front bushings which improves service of the head and rod. -

CAPABILITIES

- Secondary breaking
- Primary rock breaking
- Heavyweight concrete
- Steel-reinforced concrete
- Prestressed concrete
- Fibre-reinforced concrete
- Trenching
- Pit building
- Ground excavation
- Tunnel driving
- Roof, face & rib scaling
- Floor levelling
- Canal deepening & extension
- Dock deepening & extension
- Ground levelling
- Foundation pile driving

ATTACHMENTS AND OPTIONS PAGE 57/58



F45XP

SOUND PRESSURE

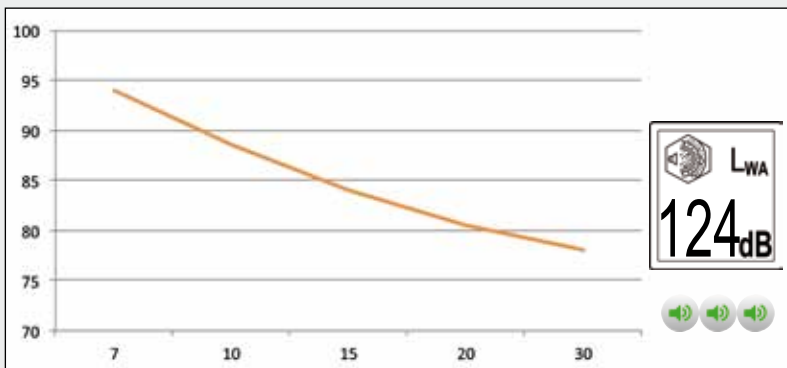

PRODUCTIVITY

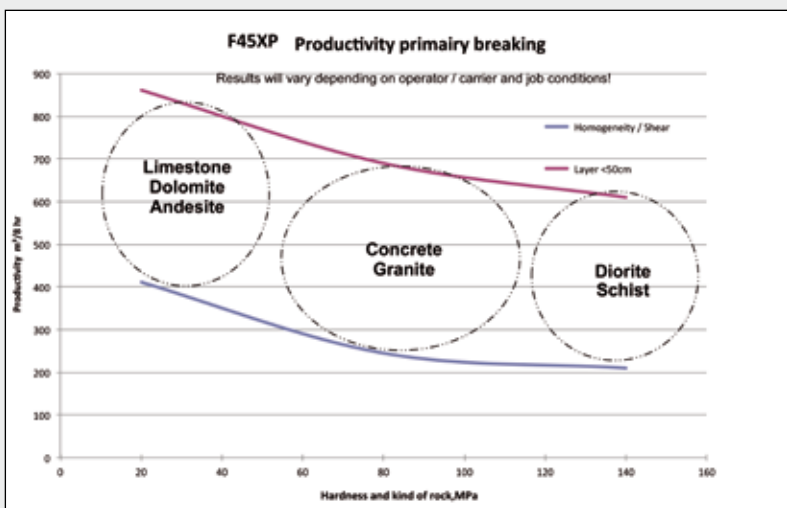

TYPE OF ROD

- Flat rod
- Moil point rod
- Wedge point rod
- Ball point rod



Specifications	F45XP	
Operating weight, ¹⁾ XP	kg	2985
Height with rod,	mm	2850
Operating pressure	min MPa	16
	max	18
Oil flow	min l/min	200
	max	250
Impact rate	min bpm	300
	max	500
Impact energy	max joules	8829
Rod diameter Ø	mm	165
Effective length rod	mm	800
Weight rod	kg	215
Hose inner dia Ø Press. Return	mm	32
Base machine weight	ton	30 - 50

¹⁾ Operating weight with top bracket. XP Silent Version = Sound and vibration damping

Specifications subject to change without notice



WHERE **EXPERIENCE** COUNTS

F70XP THE SPECIALISTS IN LARGE-SIZE EXCAVATORS

One of the largest of the F-Series, the F70XP is truly designed for use on excavators in the 45-70 ton class. Our patented dust intake prevention system keeps the internal parts of the breaker clean for improved service life. A unique greasing system lubricates both the front head and front bushings for improved service life. Considered the “quiet giant”, the F70XP’s one-piece enclosure reduces noise levels making this breaker a perfect choice for use in noise sensitive environments.

CAPABILITIES

- Secondary breaking
- Primary rock breaking
- Heavyweight concrete
- Steel-reinforced concrete
- Pre-stressed concrete
- Fibre-reinforced concrete
- Trenching
- Pit building
- Ground excavation
- Tunnel driving
- Roof, face & rib scaling
- Floor levelling
- Canal deepening & extension
- Dock deepening & extension
- Ground levelling
- Foundation pile driving

ATTACHMENTS AND OPTIONS PAGE 57/58

F70XP



SOUND PRESSURE

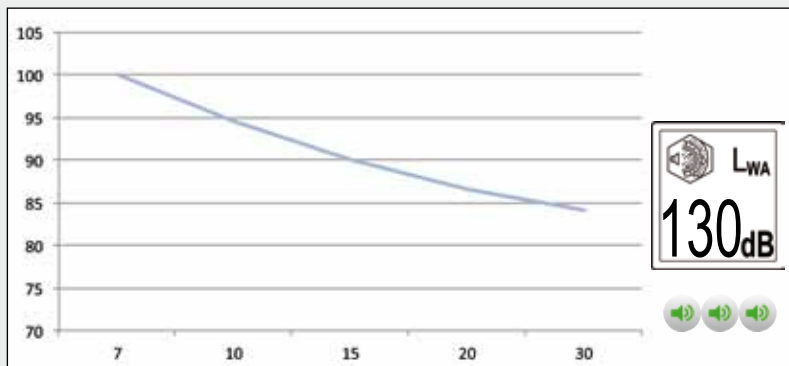

PRODUCTIVITY

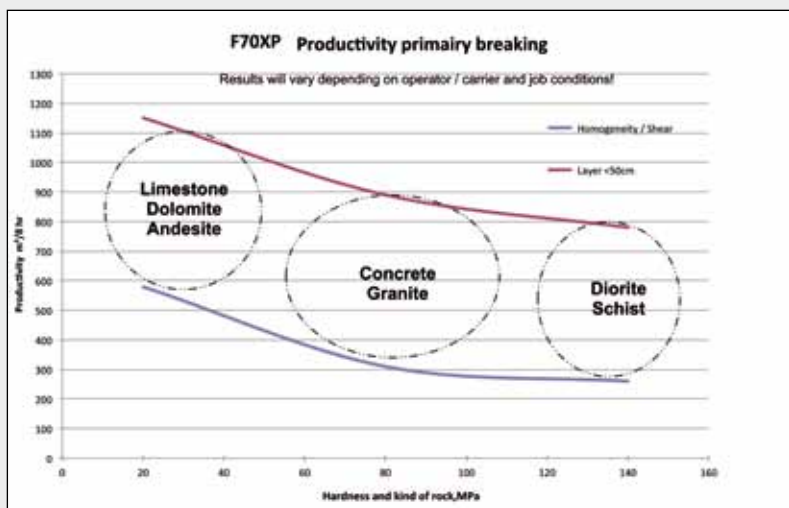

TYPE OF ROD

- Flat rod
- Moil point rod
- Wedge point rod
- Ball point rod



Specifications	F70XP	
Operating weight, ¹⁾ XP	kg	4315
Height with rod,	mm	3235
Operating pressure	min MPa	16
	max	18
Oil flow	min l/min	250
	max	340
Impact rate	min bpm	250
	max	500
Impact energy	max joules	13667
Rod diameter Ø	mm	180
Effective length rod	mm	860
Weight rod	kg	270
Hose inner dia Ø Press. Return	mm	32
Base machine weight	ton	45 - 70

¹⁾ Operating weight with top bracket. XP Silent Version = Sound and vibration damping

Specifications subject to change without notice



WHERE **EXPERIENCE** COUNTS

F100XP THE SPECIALISTS IN LARGE-SIZE EXCAVATORS

When you need to move mountains call on the F100XP. This hammer is the largest in the F Series built for use on excavators in the 65 – 100 ton class. As large as this hammer is, we still build in the quiet technology you have become accustomed to. Our blow frequency adjuster tailors the carrier and breaker to your workload improving overall efficiency. Upper and lower seal retainers protect against cylinder failure due to contamination. Retainer pins are reversible to double their life and reduce parts maintenance.

CAPABILITIES

- Secondary breaking
- Primary rock breaking
- Heavyweight concrete
- Steel-reinforced concrete
- Pre-stressed concrete
- Fibre-reinforced concrete
- Trenching
- Pit building
- Ground excavation
- Tunnel driving
- Roof, face & rib scaling
- Floor levelling
- Canal deepening & extension
- Dock deepening & extension
- Ground levelling
- Foundation pile driving

ATTACHMENTS AND OPTIONS PAGE 57/58

F100XP



SOUND PRESSURE

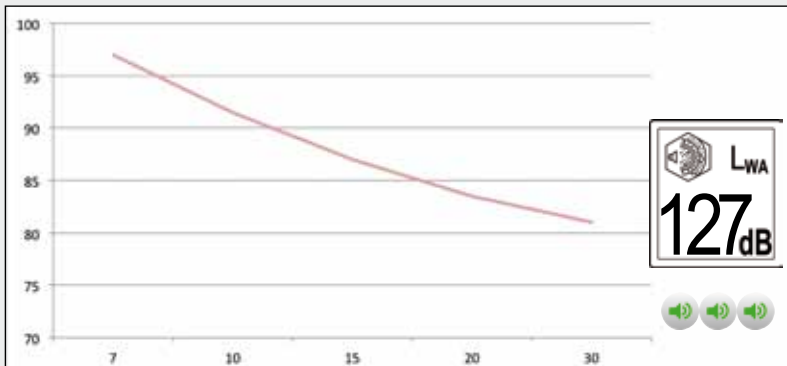

PRODUCTIVITY

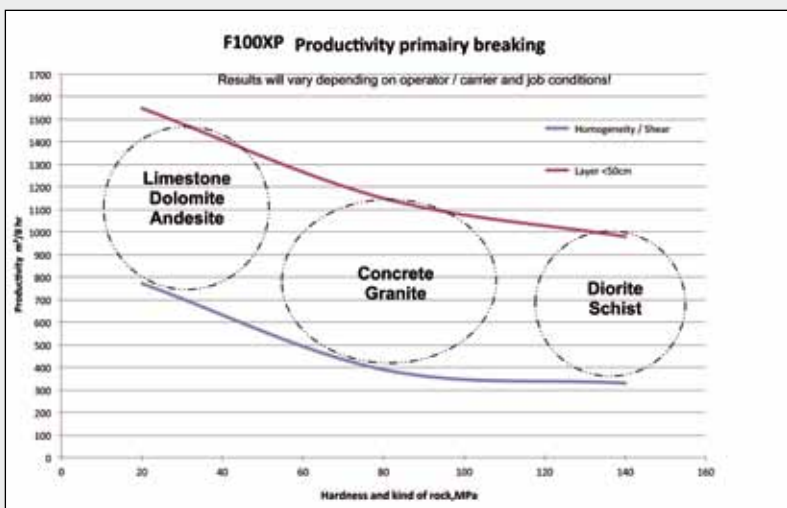

TYPE OF ROD

- Flat rod
- Moil point rod
- Wedge point rod
- Ball point rod



Specifications	F100XP	
Operating weight, ¹⁾ XP	kg	6500
Height with rod,	mm	3800
Operating pressure	min MPa	16
	max	18
Oil flow	min l/min	280
	max	390
Impact rate	min bpm	200
	max	350
Impact energy	max joules	15690
Rod diameter Ø	mm	210
Effective length rod	mm	990
Weight rod	kg	480
Hose inner dia Ø Press. Return	mm	32
Base machine weight	ton	65 - 100
<small>¹⁾ Operating weight with top bracket. XP Silent Version = Sound and vibration damping</small>		
<small>Specifications subject to change without notice</small>		



WHERE **EXPERIENCE** COUNTS

Option	FX15	FX25	FX35	FX45	FX55	F6	F9	F12XP	F19XP	F22XP	F27XP	F35XP	F45XP	F70XP	F100XP
Sencio Lubrico large	-	-	-	-	-	✓	✓	✓	✓	✓	✓	✓	✓	✓	✓
Sencio Lubrico motion	-	-	-	-	-	-	-	✓	✓	✓	✓	✓	✓	✓	✓
Remote control	-	-	-	-	-	-	-	✓	✓	✓	✓	✓	✓	✓	✓
Scaling version	-	✓	✓	✓	✓	-	-	-	-	-	-	-	-	-	-
Tunnelling version	-	-	-	-	-	-	-	✓	✓	✓	✓	✓	✓	-	-
Water spray system	-	✓	✓	✓	✓	✓	✓	✓	✓	✓	✓	✓	✓	✓	✓
Dust protection (XS Frame)	✓	✓	✓	✓	✓	-	-	series	series	series	series	series	series	series	series
Working under water (Kit)	-	-	-	-	-	✓	✓	✓	✓	✓	✓	✓	✓	✓	-
Backhoe loader frame	-	-	-	-	-	✓	-	-	-	-	-	-	-	-	-
Metallurgical (Kit)	-	✓	✓	✓	✓	✓	✓	✓	✓	✓	✓	✓	✓	✓	-
Fixed Sideport adapter	-	-	-	-	-	-	-	-	✓	✓	✓	✓	✓	✓	✓
Swivel	-	-	-	-	-	-	-	-	✓	✓	✓	✓	✓	✓	✓

✓ = option, - not available

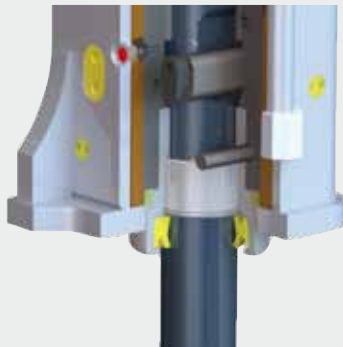

Tunnelling version F-Series

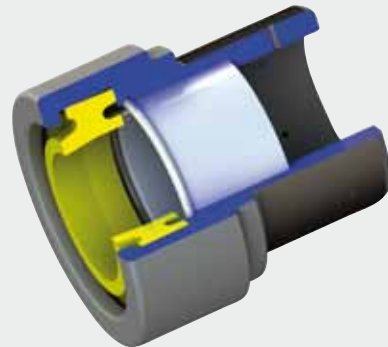

Tunnelling frontcover F-Series

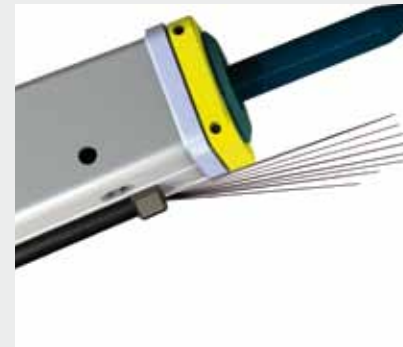

Water spray system



Compressor

OPTIONS



Remote control



Sencio Lubrico motion



Sencio Lubrico large



Swivel



Fixed Sideport adapter

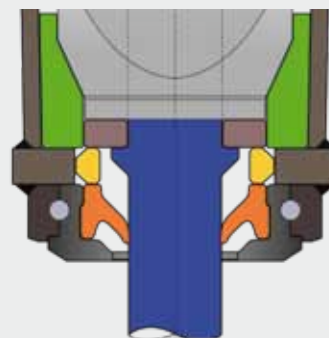

Dust protection (XS Frame)



Working under water (Kit)



Backhoe loader frame



Metallurgical (Kit)

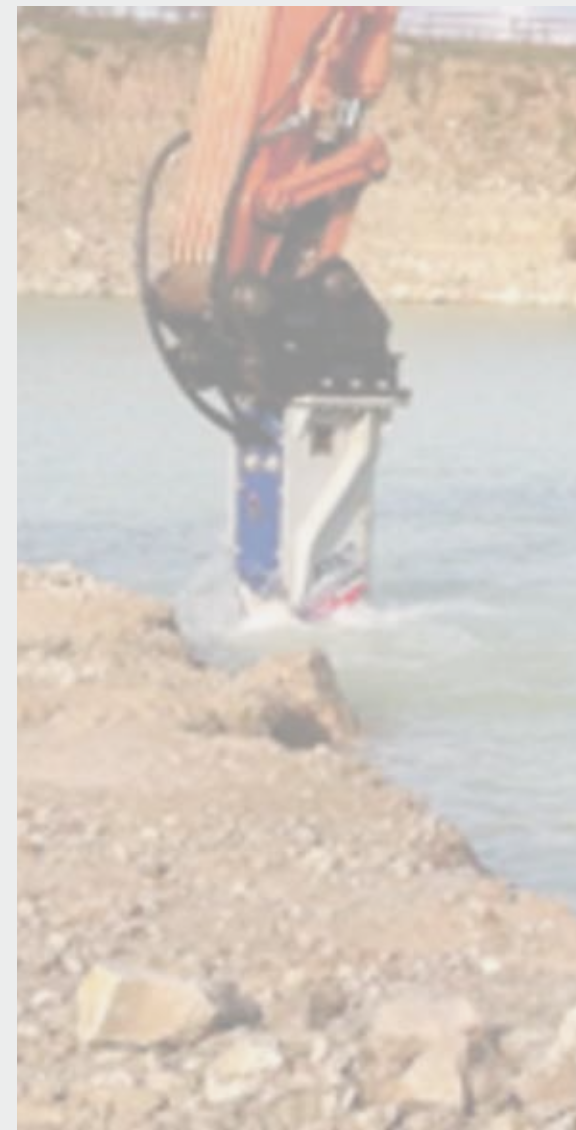

WHERE **EXPERIENCE COUNTS**

Type of rod and major applications

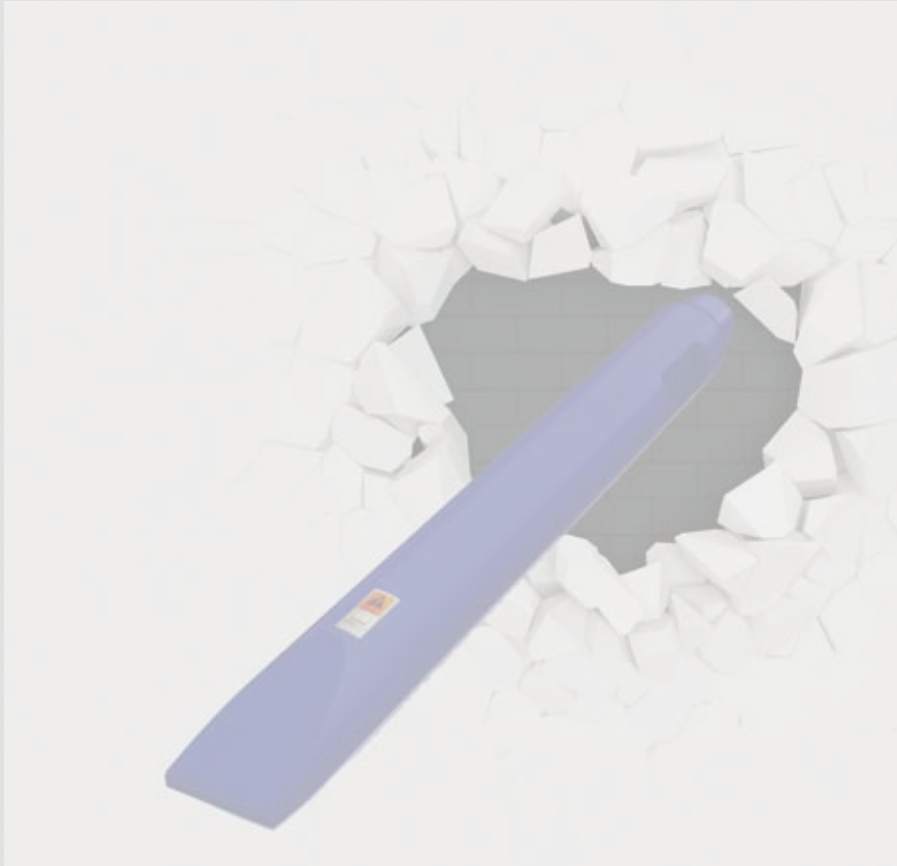

Material	Occurrence	Specification	Rod
Asphalt	Parking, Roads	soft structures	Wedge point / spade rod
Concrete	Thin floors, walls	Reinforced	Wedge point
		not reinforced	Moil point
	Thick floors, walls	Reinforced	Wedge point
		not reinforced	Moil point
Foundations	Reinforced	Wedge point	
	not reinforced	Moil point	
	Recycling		Flat rod
Sedimentary rock (limestone, sandstone, greywacke, calcareous sediment)	Trenching, foundation work, primary quarry breaking	heavily fissured	Wedge point
		lightly fissured	Moil point
	monolithic	Moil point	
	Breaking oversized		Wedge point
Crystalline rock (magma, greenstone, gabbro, granite etc.)	Trenching, foundation work, primary quarry breaking	heavily fissured	Wedge point
		lightly fissured	Flat rod
	monolithic	Flat rod	
	Breaking oversized		Flat rod

TYPE OF ROD

Type of rods	Shape		Major applications
--------------	-------	--	--------------------

Flat rod

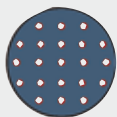

Secondary breaking in quarries, boulder breaking, concrete breaking, and slab breaking

Moil point

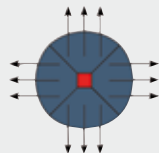
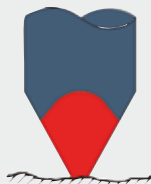

Multipurpose applications, including breaking of extra hard rock, hard rock, hard stone, and reinforced concrete, as well as excavation of bedrock

Wedge point

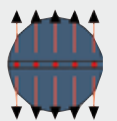
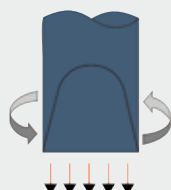

Concrete breaking, excavation of bedrock, operations on the face of slopes, excavation of ditches, etc.

Core rod
(Ball Point Rod)

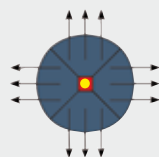

Breaking metal ores, as well as quartzite and other highly abrasive objects

Asphalt cutter /
Spade rod

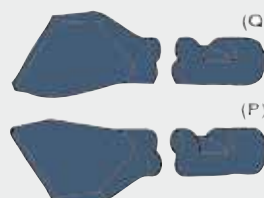
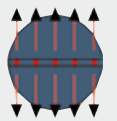
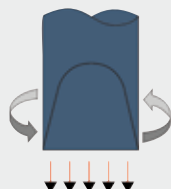

Asphalt cutter:
Cutting of asphalt or soft material
Spade rod:
Breaking of asphalt in road building, knocking out of ladles, demolition of concrete or reinforced concrete

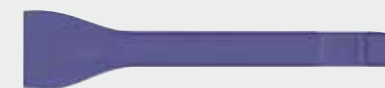
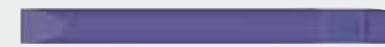
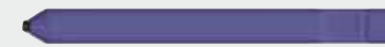
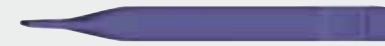

STANDARD ROD FRD HYDRAULIC BREAKERS

SMALL AND MEDIUM SERIES

Typ		FX15	FX25	FX25XS	FX35	FX35XS	FX45	FX45XS	FX55	FX55XS	F6	F9	
Spade rod	Diameter	mm	36	45	45	52	52	60	60	68	68	75	90
	Part	No.	F1-25114	HB2G-25114	002306-250040	F3-25114	002307-250040	F4-25114	002308-250040	F5-25114	002309-250040	F6-25114	F9-25114
	Length	mm	370	460	515	510	565	560	615	600	655	730	840
	Effective Length	mm	234	293	293	322	322	355	355	378	378	450	500
	Weight	kg	2,8	5	5,8	8	8,5	11	12,1	15	16,4	21,5	35,5
Cone rod	Part	No.	F1-25115	HB2G-25115	002306-250060	F3-25115	002307-250060	F4-25115	002308-250060	F5-25115	002309-250060	-	-
	Length	mm	370	460	515	510	565	560	615	600	655	-	-
	Effective Length	mm	234	293	293	322	322	355	355	378	378	-	-
	Weight	kg	2,8	5	5,8	8	8,5	11	12,1	15	16,4	-	-
	Moil point	Part	No.	-	-	-	-	-	-	-	-	-	F6-25113
Length		mm	-	-	-	-	-	-	-	-	-	730	840
Effective Length		mm	-	-	-	-	-	-	-	-	-	450	500
Weight		kg	-	-	-	-	-	-	-	-	-	21,5	35,5
Core rod (Ball Point Rod)		Part	No.	-	HB2G-25116	002306-250030	F3-25116	002307-250030	F4-25116	002308-250030	F5-25116	002309-250030	F6-25116
	Length	mm	-	460	460	510	510	560	560	600	600	730	840
	Effective Length	mm	-	293	293	322	322	355	355	378	378	450	500
	Weight	kg	-	5	5	8	8	11	11	15	15	21,5	35,5
	Flat rod	Part	No.	F1-25111	HB2G-25111	023606-250010	F3-25111	002307-250010	F4-25111	002308-250010	F5-25111	002309-250010	F6-25111
Length		mm	370	460	515	510	565	560	615	600	655	730	840
Effective Length		mm	234	293	293	322	322	355	355	378	378	450	500
Weight		kg	2,8	5	5,8	8	8,5	11	12,1	15	16,4	21,5	35,5
Wide rod		Part	No.	F1-25110	HB2G-25110	on request	F3-25110	on request	F4-25110	on request	F5-25110	on request	F6-25110
	Length	mm	440	440		500		500		560		670	740
	Effective Length	mm	115	120		140		150		150		150	180
	Weight	kg	3,7	5		8,5		9		16,5		20	33
	Asphalt cutter	Part	No.	F1-25117	HB2G-25117	on request	F3-25117	on request	F4-25117	on request	F5-25117	on request	F6-25117
Length		mm	440	450		510		520		590		700	780
Effective Length		mm	125	100		115		130		150		150	200
Weight		kg	3,7	5		8,5		9		16,5		20	33

TYPE OF ROD

LARGE SERIES

Typ		F12XP	F19XP	F22XP	F27XP	F35XP	F45XP	F70XP	F100XP	
Spade rod	Diameter	mm	105	120	135	140	150	165	180	210
	Part No.		F12-25214	F19-25224	F22-25224	F27-25324	F35-25224	F45-25214	F70-25204	HB100G-22204
	Length	mm	1090	1180	1250	1310	1405	1510	1600	1850
	Effective Length	mm	650	700	725	750	775	800	860	967
	Weight	kg	68	100	128	145	150	215	270	480
Moil point	Part No.		F12-25213	F19-25223	F22-25223	F27-25323	F35-25223	F45-25213	F70-25203	HB100G-22203
	Length	mm	1090	1180	1250	1310	1405	1510	1600	1850
	Effective Length	mm	650	700	725	750	775	800	860	967
	Weight	kg	68	100	128	145	150	215	270	480
	Core rod (Ball Point Rod)	Part No.		F12-25216	F19-25216	F22-25316	F27-25316	F35-25216	F45-25216	F70-25206
Length		mm	1090	1180	1250	1310	1405	1510	1600	-
Effective Length		mm	650	700	725	750	775	800	860	-
Weight		kg	68	100	128	145	150	215	270	-
Flat rod		Part No.		F12-25211	F19-25221	F22-25221	F27-25321	F35-25221	F45-25211	F70-25201
	Length	mm	1090	1180	1250	1310	1405	1510	1600	1850
	Effective Length	mm	650	700	725	750	775	800	860	967
	Weight	kg	68	100	128	145	150	215	270	480

WHERE **EXPERIENCE COUNTS**



MORE FRD PRODUCTS

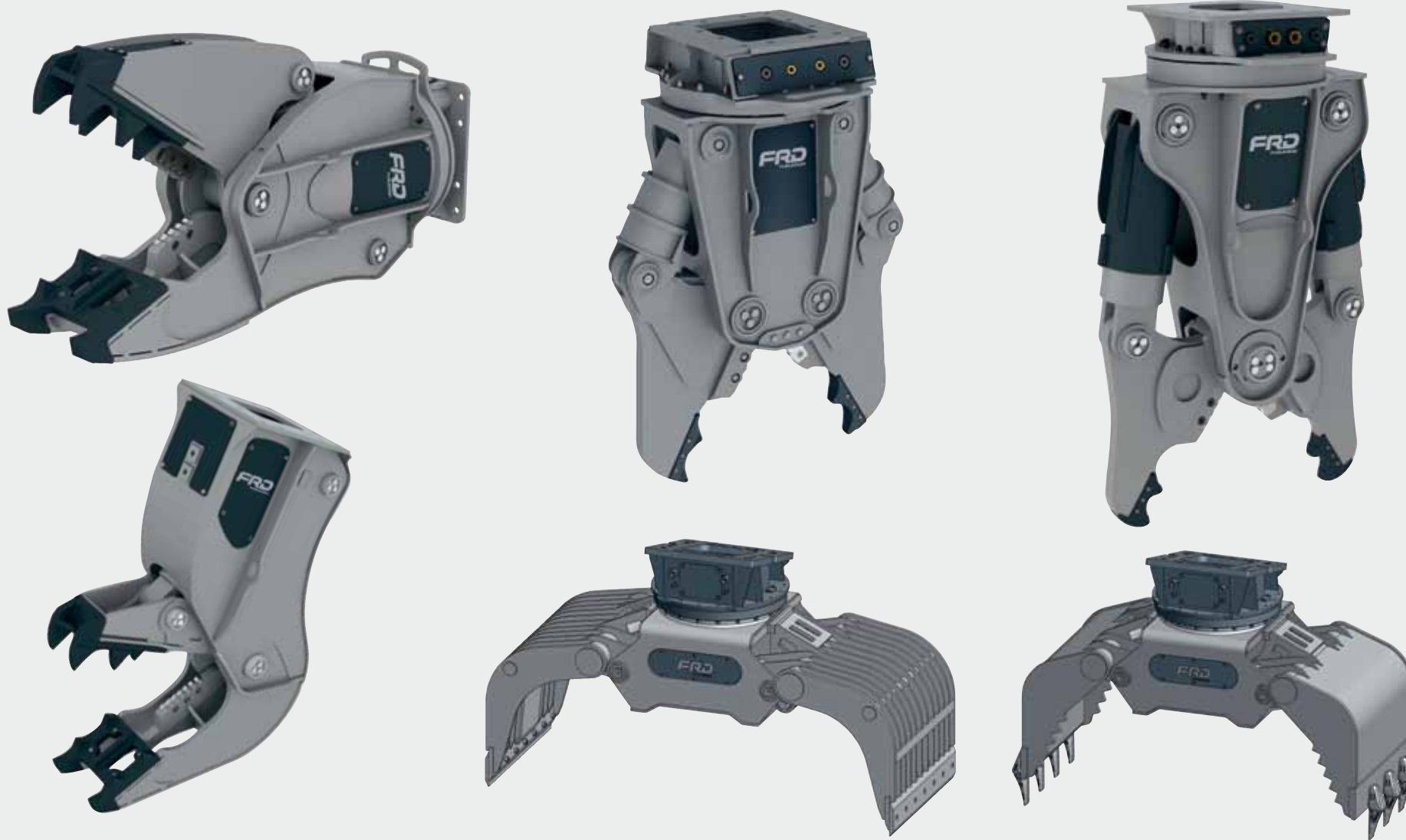

WHERE **EXPERIENCE COUNTS**

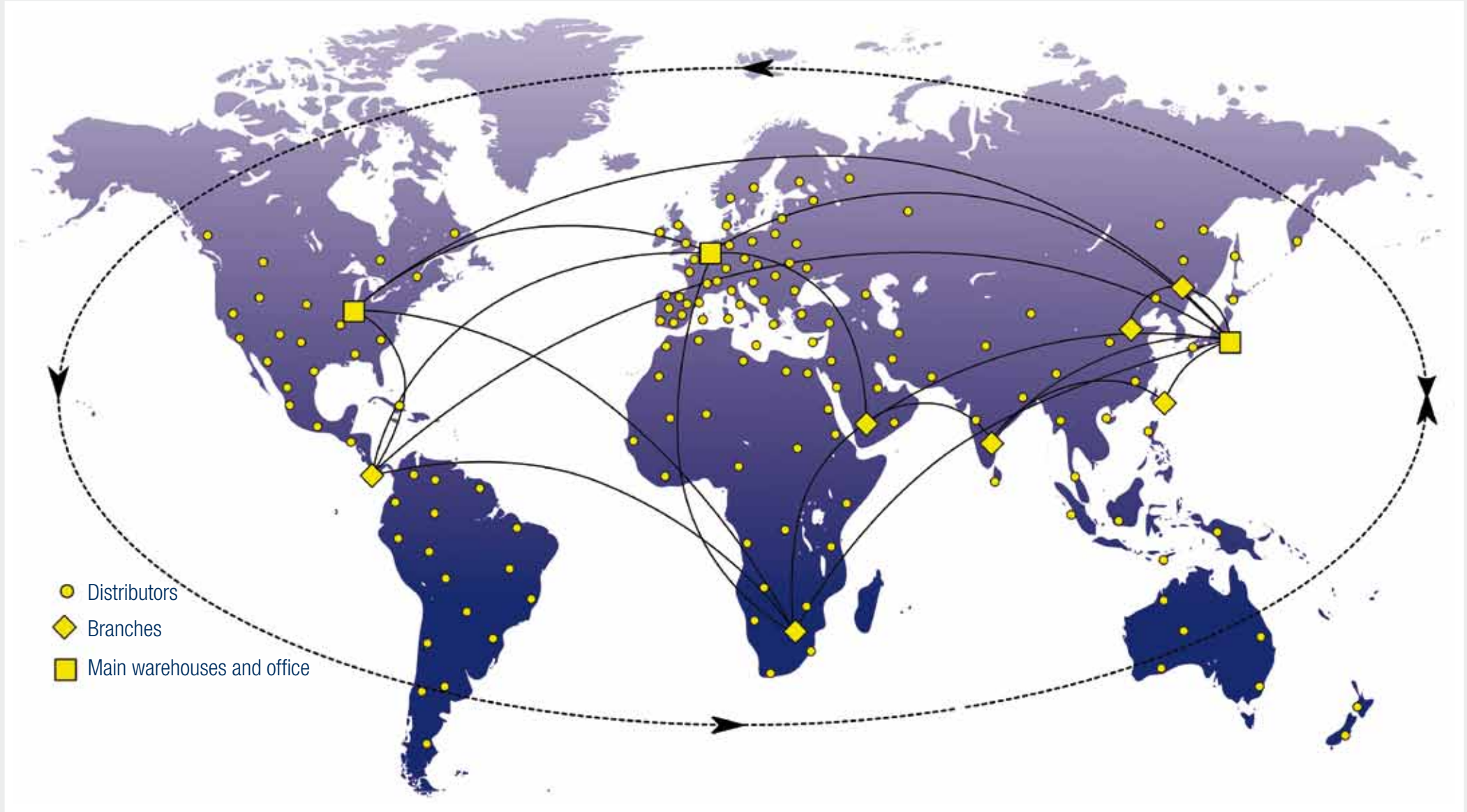

GLOBAL DISTRIBUTOR NETWORK

LOCAL SERVICE AND SUPPORT

FRD seeks firstly to supply a product of undoubted integrity. Then back this up with a support network of dedicated Distributors to ensure whatever support, wherever and whenever needed. The FRD-Distributor combination has been made unbeatable.

FRD Distributors have been selected for their professional competence, their market coverage, their dedication to quality and their willingness to work. They receive intense training on all machines and systems and every support that a committed manufacturer can give them. They actively exchange experience between each other to ensure their clients get the latest lessons from the market. They are a skilled and fast team of professionals.

VALUE FOR MONEY

Buying FRD products is a smart investment. A reasonable price for top quality, long lifetime, low maintenance and low breakdown time products in the long term makes financially good sense.

Next steps? FRD Europe and its Distributors have a vast resource of information beyond what can be mentioned here. Do not hesitate to get in touch for more detail and an unbeatable quote.



WHERE **EXPERIENCE COUNTS**



WHERE EXPERIENCE COUNTS

DISTRIBUTOR:

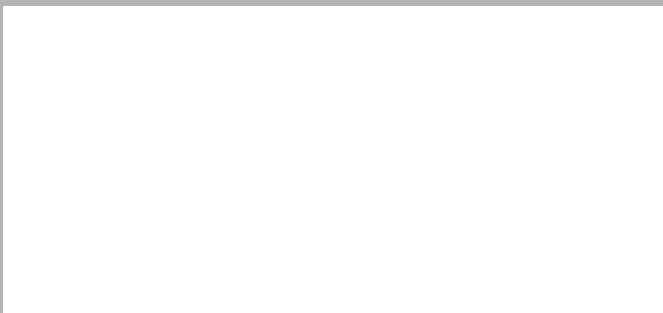

Furukawa Rock Drill Europe BV

Proostwetering 29, 3543 AB Utrecht, The Netherlands
Phone +31-(0)30-2412277, Fax +31-(0)30-2412305
www.frd.eu