

# KOMATSU

**D**  
**65**



Crawler Dozer

## **D65EX/WX/PX-17**

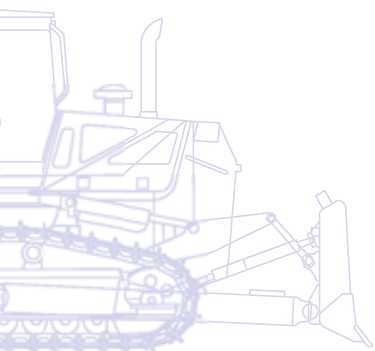

**ENGINE POWER**

164 kW / 219 HP @ 1.950 rpm

**OPERATING WEIGHT**

D65EX-17: 22.620 kg

D65WX-17: 23.520 kg

D65PX-17: 22.990 kg

# Walk-Around

The D65-17 dozer integrates well proven Komatsu technology with a powerful and fuel efficient power train, the revolutionary Sigmadozer® blade and a highly efficient automatic transmission with torque converter lock-up. The new EU Stage IIIB/EPA Tier 4 interim engine platform provides it with increased net horsepower and lowers fuel consumption and emissions. An advanced electronic control system manages airflow rate, fuel injection and combustion parameters to optimize performance and to further reduce emissions. Remarkably efficient both for ripping and for dozing, the D65-17 is a productive and reliable Komatsu dozer that will quickly become a trusted working partner.

## High productivity & low fuel consumption

- Unique torque converter with auto lock-up
- Automatic transmission
- Clean, powerful engine
- EU Stage IIIB/EPA Tier 4 interim
- Selectable working modes

## Optimized work equipment

- Sigmadozer® blade with hydraulic pitch
- INPAT blade
- Multishank parallelogram ripper
- Komatsu-Topcon machine control systems



# D65-17

**ENGINE POWER**  
164 kW / 219 HP @ 1.950 rpm

**OPERATING WEIGHT**  
D65EX-17: 22.620 kg  
D65WX-17: 23.520 kg  
D65PX-17: 22.990 kg

## First-Class Operator Comfort

- Quiet and comfortable cab
- Fully adjustable air suspension seat
- Superior visibility on blade and ripper
- Less noise and vibrations
- Integrated rear view camera system



## State of the art controls

- Hydrostatic steering system
- Gearshift preset function
- Easy and precise
- Remote safety lock levers
- Large TFT colour multi monitor



## Tough and reliable

- Low-drive "PLUS" undercarriage
- Self-adjusting idler support
- Sturdy, rugged design
- Stable in any configuration (EX/WX/PX)

**KOMTRAX**

Komatsu wireless  
Monitoring System

# High Productivity & Low Fuel Consumption

## New Komatsu engine technology

The powerful and fuel-efficient Komatsu SAA6D114E-5 engine in the D65-17 delivers 164 kW/219 HP at 1.950 rpm and is EU Stage IIIB/ EPA Tier 4 interim certified. To maximise power, fuel efficiency and emission compliance, it is turbo charged and features direct fuel injection, air-to-air after cooling and cooled EGR.

## Torque converter with auto lock-up

Combined with the automatic transmission, the exclusive Komatsu automatic lock-up torque converter reduces fuel consumption by up to 10% by eliminating unnecessary power loss. When required, the power train control system engages the torque converter, or locks it up to send full engine power directly to the transmission during less torque demanding applications.

## Automatic transmission

Set by default, the D65-17's highly efficient transmission automatically matches the best gear mode for all dozing and ripping operations and includes a travel speed preset function to reduce work time and operator's efforts. Thanks to Komatsu's ECMV (Electronic Controlled Modulation Valves), gear changes are smoothly timed to always keep the power transfer at maximum efficiency.

**KDPF - Komatsu Diesel Particulate Filter**  
Komatsu's high efficiency DPF captures more than 90% of particulate matter. It includes a special oxidation catalyst with fuel injection system that can incinerate trapped particulates by either active or passive regeneration with no need to interrupt machine operations.

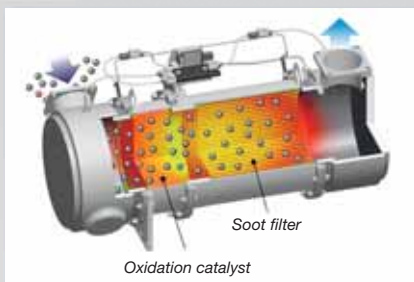

**EGR - Exhaust Gas Recirculation**  
Cooled EGR is a technology well-proven in current Komatsu engines. The increased capacity of the EGR cooler now ensures very low NOx emissions and a better engine performance.

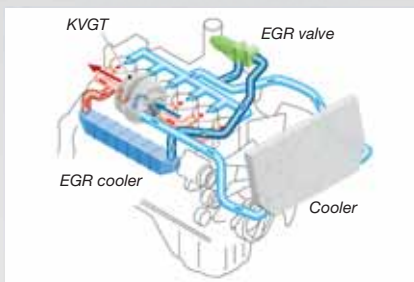

**KVGT - Komatsu Variable Geometry Turbocharger**  
The KVGT provides optimal air flow to the engine combustion chamber under all speed and load conditions. Exhaust gas is cleaner, fuel economy is improved while machine power and performance are maintained.

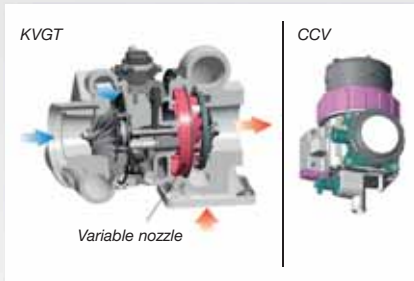

**CCV - Closed Crankcase Ventilation**  
Crankcase emissions (blow-by gas) are passed through a CCV filter. The oil mist trapped in the filter is returned back to the crankcase while the filtered gas is returned to the air intake.

**HPCR - High-Pressure Common Rail**  
To achieve complete fuel burn and lower exhaust emissions, the heavy duty High-Pressure Common Rail fuel injection system is computer controlled to deliver a precise quantity of pressurised fuel into the redesigned engine combustion chamber by multiple injections.

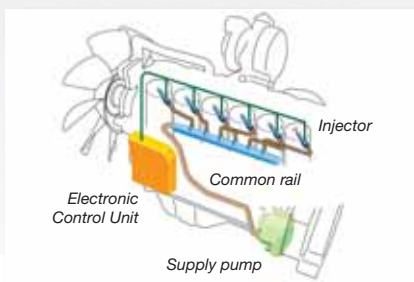



## Selectable working modes

Working mode can be set to either “Power” for maximum power or to “Economy” for energy saving operations. Combined with a choice between automatic or manual working mode, this lets the operator select the optimum machine power configuration for the work at hand.



# Optimized Work Equipment

## Sigmodozer® blade (EX/WX)

The middle section of Komatsu's Sigmodozer® blade acts like a V-shaped bucket with aggressive ground penetration. Its lateral blade edges help to push the rolling material continuously towards the centre. Combined with the blade's deep curve this largely increases effective capacity and reduces spillage and fuel consumption. The blade's flat cutting edge and the standard pitch function also offer top grading performance. Overall, the Sigmodozer® blade increases dozing productivity by more than 15% compared to a conventional Semi-U blade.

## INPAT blade

Perfectly sized to maximize blade versatility, a new straight INPAT dozer blade with a highly durable box structure is available for all models (EX/WX/PX) and makes the D65-17 a perfect tool for a wide range of applications. A fold-up version of the INPAT blade for the WX and PX machines guarantees a transport width of 3 metres and easy transportation between job-sites.

## Multishank parallelogram ripper (EX/WX) (option)

The multishank parallelogram ripper has 3 ripper shanks as standard, but can be easily converted to a giant or two-shank ripper, depending on job conditions. The strong parallelogram design offers straight shank movement, adapted for tough applications.

## Komatsu-Topcon machine control systems (option)

Automatic blade movements on a dozer greatly improve dozing productivity and grading accuracy. They also allow operators to work faster and more safely with a reduced workload. Komatsu-Topcon machine control systems are the best way to automate blade movements. Depending on the control system used, blade movement can be monitored or fully automated. As a result, even inexperienced operators work much faster and deliver a high-quality final graded area. All the information from the laser or GPS systems is constantly available on an in-cab display, clearly showing the slope and elevation.



The Sigmodozer® blade offers highest material holding capacity

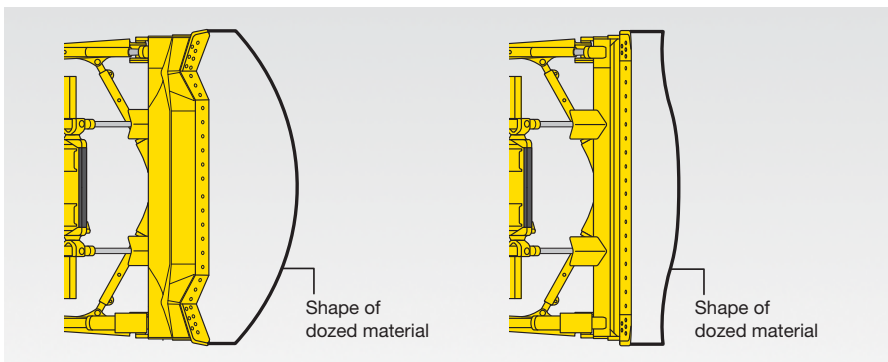

Up to 15% higher production with the improved Sigmodozer® blade (left), compared to conventional Semi-U blade (right).



Hydraulically adjustable tilt: 870 mm



# First-Class Operator Comfort

## Quiet and comfortable cab

Operator comfort is essential for safe and productive work. The D65-17 provides a quieter and comfortable cab, the ideal environment to concentrate on the job at hand. The cab's hexagonal design and large tinted glass windows offer excellent panoramic visibility. The high capacity and fully automatic climate control system pressurizes the cab to keep dust out. A high quality sound absorbent lining covers the interior to minimize operator ear noise levels.

## Fully adjustable suspension seat and travel control console

A comfortable, heavy-duty and fully adjustable heated air suspension seat is at the centre of the operator's safe and cosy work space. For dozing operations, the seat faces straight forward, with a perfect view of both sides of the blade. For ripping, it can be turned 15° to the right, significantly improving rear visibility and reducing neck strain. The position of the travel control console can also be independently adjusted fore, aft and in height to fit each operator's preference.

## Superior visibility on blade and ripper

The redesigned ROPS/FOPS integrated cab and the well-located operator seat give optimal blade visibility to the left and right and make both dozing and grading easy, safe and fast. To further improve safety and ripping efficiency the special shape of the fuel tank gives the operator a clear view of the ripper point and of the dozer's back side.

## Less noise and vibrations

The D65-17 cab mounts use a cab damper that provides excellent shock and vibration absorption with its long stroke and exclusive design. Cab damper mounts significantly soften shocks and vibrations that conventional mounting systems are unable to absorb.



Rear view camera system







# State of the Art Controls

## Hydrostatic steering system

The hydrostatic steering system (HSS) offers fast response and more precise turning. Both tracks are powered without interruption allowing smooth, continuous turns and powerful and productive dozing even on soft ground or on slopes.

## Gearshift preset function

To reduce the frequency of gear shifting and for comfortable machine operation, a shift preset mode is provided as standard equipment. The preset switch located on the steering lever reduces repetitive gear shifting by the operator and increases operation efficiency.

## Easy and precise

The ergonomic Palm Command Control System (PCCS) provides efficient and comfortable steering. The blade control joystick uses Proportional Pressure Control (PPC) for precise operations, excellent and easy grading jobs - and better productivity. When backing up over shot rock or other rough surfaces, travel speed can be reduced with the "slow reverse" function to improve ride quality and decrease vibrations and fuel consumption.

## Remote safety lock levers

For extra operator comfort and convenience, remote safety lock levers were added to engage or release the work equipment and travel shut-off bars.





## Large TFT colour multi monitor

A large user-friendly colour monitor with simple and easy to operate switches enables safe, accurate and smooth work. It displays the status of the diesel particle filter and provides other on-hand data to continuously improve productivity and fuel consumption.



# Tough and Reliable

## Low-drive "PLUS" undercarriage

Komatsu's new low-drive Parallel Link Undercarriage System (PLUS) is extraordinarily tough, with excellent grading performance and stability. It features PLUS link assemblies, a highly reliable floating bushing concept, substantial track link height, superior oil seals and track guards that maximise undercarriage durability. For easier servicing, the equalizer bar's centre pin is remotely greased. The segmented sprockets are notched to considerably improve the evacuation of mud and further increase the PLUS undercarriage lifetime.

## Sturdy, rugged design

A high-rigidity hull structure main frame improves durability and reduces stress concentration at critical areas. The track frame with a large cross section utilizes pivot shaft mounting for greater reliability. All hydraulic piping is robustly protected by cover and inner route to ensure damage protection from materials.

## Stable in any configuration (EX/WX/PX)

For complete stability in any working condition the D65-17 is available in 3 different PLUS undercarriage configurations. On rocky ground, the EX undercarriage, with small-width shoes, ensures maximum contact area between the machine and the ground. The PX version has the widest undercarriage shoes and is ideal for soft surfaces. Finally, the WX machine is perfectly suited for most jobs with medium width undercarriage shoes and the same length of track on ground as an EX model machine.

## Self-adjusting idler support

The self-adjusting idler support provides constant and even tension on idler guide plates. It reduces noise levels and vibrations and increases undercarriage life while improving grading performance.



*Self-adjusting idler support*



*Hydraulic lines are embedded into the structures whenever possible*



*Komatsu PLUS undercarriage: When conventional undercarriages are long gone, the PLUS undercarriage keeps going strong.*

# Komatsu Wireless Monitoring System

## The easy way to higher productivity

KOMTRAX™ is the latest in wireless monitoring technology. It delivers insightful and cost saving information about your fleet and equipment and offers you a wealth of information to facilitate peak machine performance. By creating a tightly integrated web of support it allows pro active and preventive maintenance and helps you to efficiently run a business.

## Knowledge

You get quick answers to basic and critical questions about your machines - what they're doing, when they did it, where they're located, how they can be used more efficiently, and when they need to be serviced. Performance data is relayed by satellite from your machine to your computer and to your local Komatsu distributor - who's readily available for expert analysis and feedback.

## Convenience

KOMTRAX™ helps to conveniently manage your fleet on the web, wherever you are. Data is analysed and packaged specifically for easy and intuitive viewing in maps, lists, graphs and charts. You can anticipate the type of service and parts your machines could require, or troubleshoot problems before Komatsu technicians arrive on site.





## Power

The detailed information that KOMTRAX™ puts at your fingertips 24 hours a day, 7 days a week gives you the power to make better daily and long-term strategic decisions. You can anticipate problems, customize maintenance schedules, minimize downtime and keep your machines where they belong – working on the job site.

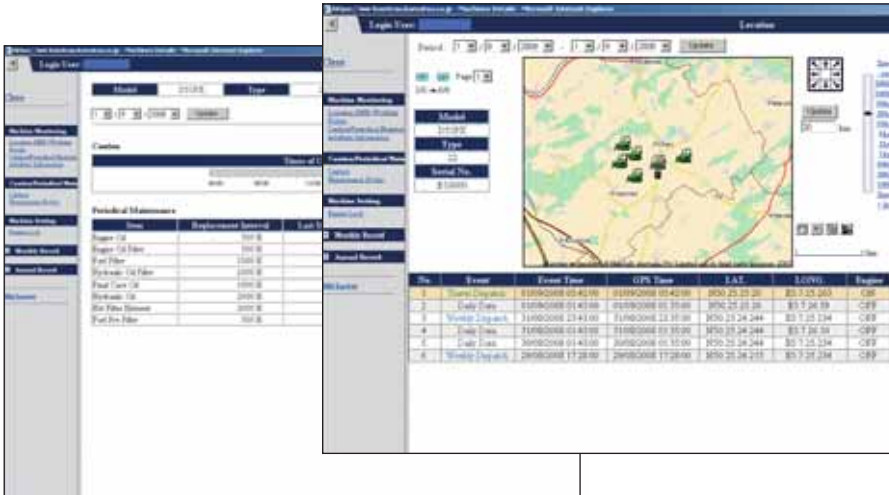

Through the web application, a variety of search parameters are available to quickly find information about specific machines based on key factors such as utilization rates, age, various notification messages, and more.

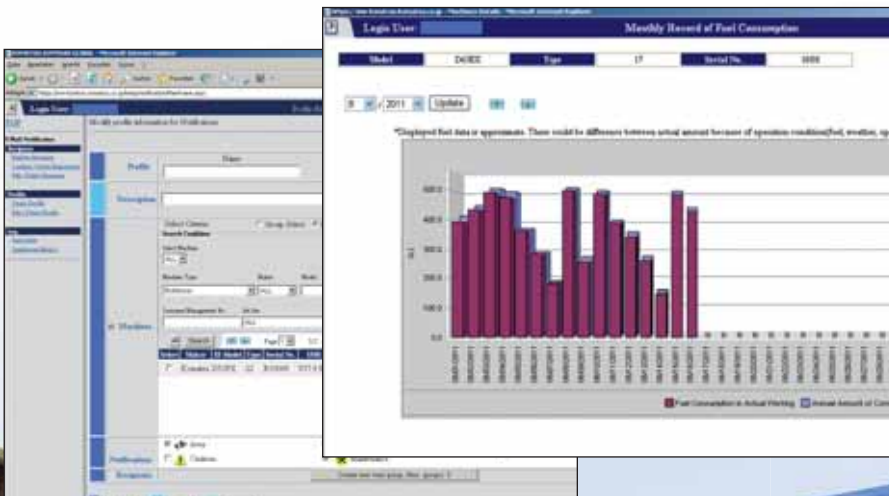

A simple chart shows the machine's fuel consumption and helps you to calculate total costs for a job site and conveniently schedule fuel deliveries.

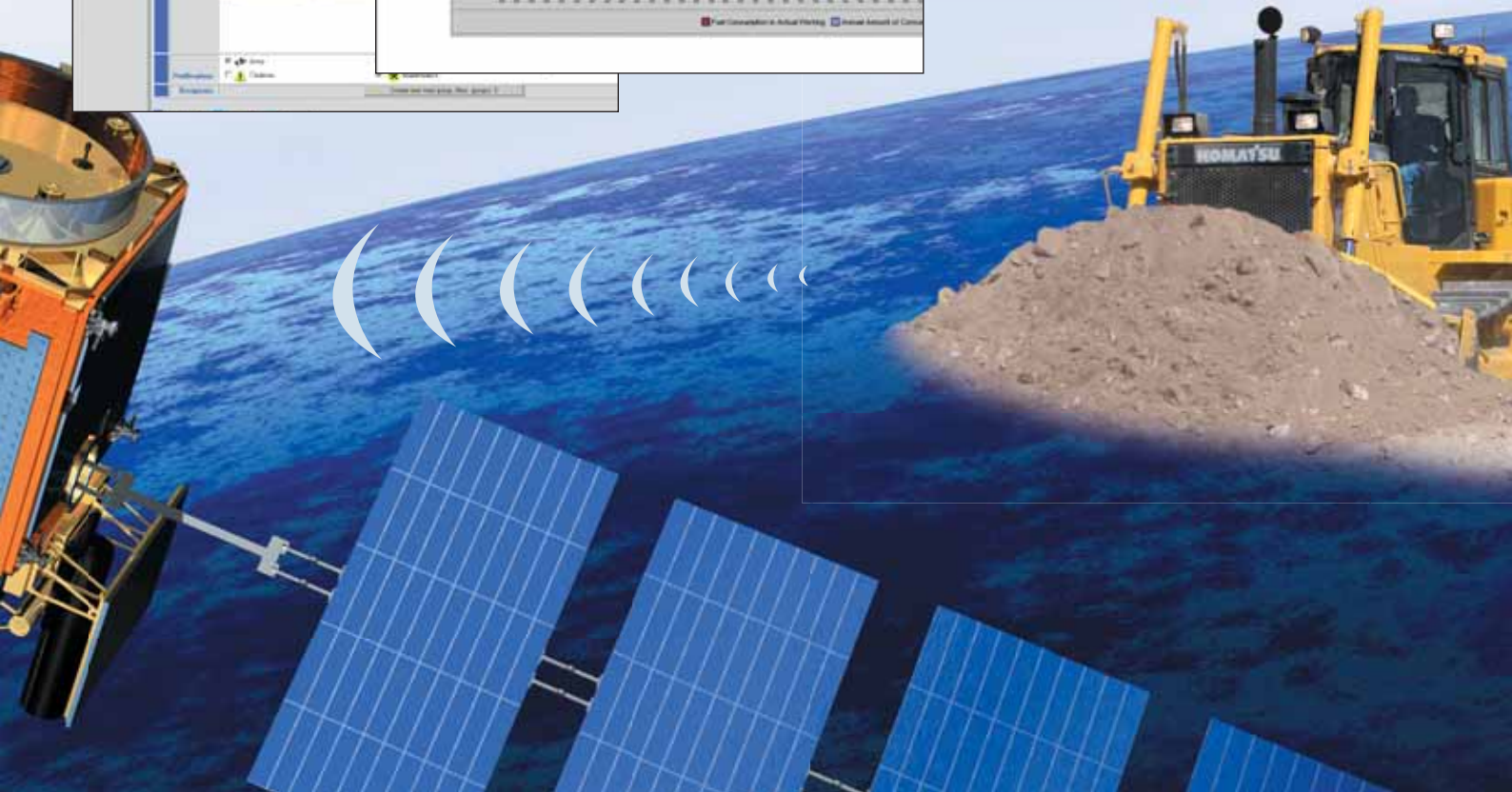

# Easy Maintenance

## Centralised service station

Preventative maintenance is essential to ensure the long life of your equipment. Komatsu designed the D65-17 with centralised and conveniently located service points to make necessary inspections and maintenance quick and easy.

## Reversible radiator fan

The radiator can be easily cleaned by utilization of the reversible, hydraulically driven cooling fan from a touch on the monitor panel. This cleaning reduces fuel consumption and increases overall machine performance.

## Modular power train

All the power train components are enclosed in a sealed module. This eliminates oil spills during mounting and dismounting, and prevents dust and dirt polluting individual components. Servicing is much cleaner, smoother and easier.

## Self-diagnostic monitor

Simple warning functions, service interval announcements and key operational functions are displayed on the new centralised monitor panel. At a glance, any operator can select the best options to get the best out of the D65-17. In addition, when required, countermeasures are clearly indicated on the screen to enable the operator or service people to quickly take correct and safe action, and keep the machine free of costly major problems and downtime.

## Diesel particulate filter (DPF) cleaning

If needed, the Komatsu DPF system is easy to maintain by simply replacing one complete used cartridge with a new one. A replacement cartridge is made available as Reman exchange module, offering a cost effective solution with minimum downtime.





## ENGINE

Model ..... Komatsu SAA6D114E-5  
 Type ..... Common rail direct injection, water-cooled, emissionised, turbocharged, after-cooled diesel

Engine power  
 at rated engine speed ..... 1.950 rpm  
 ISO 14396 ..... 164 kW / 219 HP  
 ISO 9249 (net engine power) ..... 153 kW / 205 HP

No. of cylinders ..... 6  
 Bore x stroke ..... 114 x 144,5 mm  
 Displacement ..... 8,85 ltr  
 Governor ..... All-speed, electronic

Lubrication system  
 Method ..... Gear pump, force lubrication  
 Filter ..... Full flow

## TORQFLOW TRANSMISSION

Type ..... Komatsu TORQFLOW  
 Torque converter ..... 3-element, 1-stage, 2-phase, water-cooled, with automatic lock-up function  
 Transmission ..... Planetary gear, multiple-disc clutch, hydraulically actuated, force-lubricated  
 Gearshift lock lever and neutral safety switch prevent accidental starts.

## MAX. TRAVEL SPEEDS

	Forward	Reverse
1st	3,6 km/h	4,5 km/h
2nd	5,6 km/h	6,7 km/h
3rdL	7,3 km/h	8,7 km/h
3rd	11,3 km/h	13,6 km/h

## STEERING SYSTEM

Type ..... Hydrostatic Steering System (HSS)  
 Steering control ..... PCCS-lever  
 Service brakes ..... Wet, multiple-disc, pedal-controlled, spring-actuated and hydraulically released

### Minimum turning radius (counter-rotation)

D65EX-17 with Sigmadozer® blade	1,9 m
D65EX-17 with INPAT blade	2,0 m
D65WX-17 with Sigmadozer® blade	2,1 m
D65WX-17 with INPAT blade	2,0 m
D65PX-17 with straight tilt blade	2,2 m
D65PX-17 with INPAT blade	2,2 m

## FINAL DRIVE

Type ..... Spur gear, planetary gear, double-reduction  
 Sprocket ..... Segmented sprocket teeth are bolt-on for easy replacement

## SERVICE REFILL CAPACITIES

Fuel tank	415 ltr
Radiator	54 ltr
Engine oil	30 ltr
Torque converter, transmission, bevel gear, and steering system	53 ltr
Final drive (each side)	
D65EX-17	21 ltr
D65EX-17 with INPAT blade	27 ltr
D65WX-17	25 ltr
D65PX-17	25 ltr
Work equipment hydraulics	55 ltr

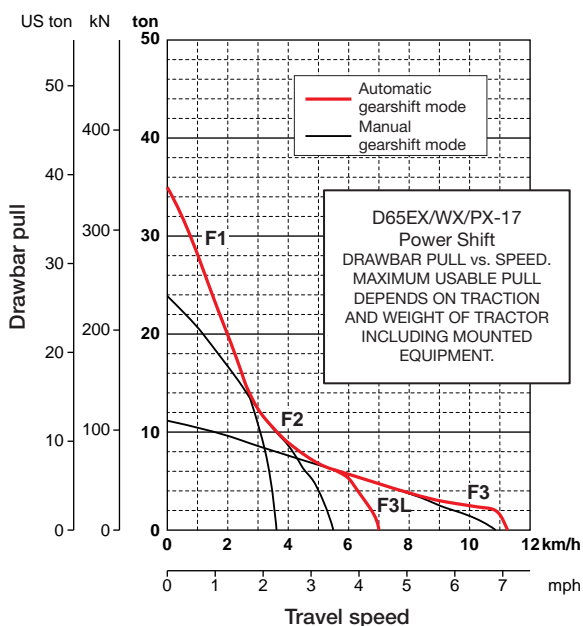

## ENVIRONMENT

Engine emissions ..... Fully complies with EU Stage IIIB and EPA Tier 4 interim exhaust emission regulations

### Noise levels

LwA external	108 dB(A) (2000/14/EC)
LpA operator ear	78 dB(A) (ISO 6396 dynamic test)

### Vibration levels (EN 12096:1997)\*

Hand/arm	≤ 2,5 m/s <sup>2</sup> (uncertainty K = 0,7 m/s <sup>2</sup> )
Body	≤ 0,5 m/s <sup>2</sup> (uncertainty K = 0,3 m/s <sup>2</sup> )

\* for the purpose of risk assessment under directive 2002/44/EC, please refer to ISO/TR 25398:2006.

# Specifications

## UNDERCARRIAGE

Suspension.....	Oscillating equaliser bar and pivot shaft
Track roller frame.....	Monocoque, large section, durable construction
Rollers and idlers.....	Lubricated track rollers
Tracks .....	PLUS link assembly
Track tension .....	Combined spring and hydraulic unit

### D65EX-17

Type of blade	Sigmodozer®	INPAT
Number of track rollers (each side)	7	7
Number of shoes (each side)	42	42
Shoe width (standard)	610 mm	560 mm
Ground contact area*	36.234 cm <sup>2</sup>	33.264 cm <sup>2</sup>
Ground pressure	0,61 kg/cm <sup>2</sup>	0,68 kg/cm <sup>2</sup>
Track gauge	1.880 mm	2.050 mm
Length of track on ground	2.970 mm	2.970 mm

### D65WX-17

Type of blade	Sigmodozer®	INPAT
Number of track rollers (each side)	7	7
Number of shoes (each side)	42	42
Shoe width (standard)	760 mm	760 mm
Ground contact area*	45.144 cm <sup>2</sup>	45.144 cm <sup>2</sup>
Ground pressure	0,50 kg/cm <sup>2</sup>	0,52 kg/cm <sup>2</sup>
Track gauge	2.050 mm	2.230 mm
Length of track on ground	2.970 mm	2.970 mm

### D65PX-17

Type of blade	Straight tilt	INPAT
Number of track rollers (each side)	8	8
Number of shoes (each side)	45	45
Shoe width (standard)	915 mm	760 mm
Ground contact area*	59.932 cm <sup>2</sup>	49.780 cm <sup>2</sup>
Ground pressure	0,37 kg/cm <sup>2</sup>	0,46 kg/cm <sup>2</sup>
Track gauge	2.050 mm	2.230 mm
Length of track on ground	3.275 mm	3.275 mm

\* Including blade and ripper (EX/WX), steel cab, ROPS, hydraulic control unit, operator, standard equipment, rated capacity of lubricant, coolant, and full fuel tank.

## MULTISHANK RIPPER DIMENSIONS

A	1.900 mm
B	2.170 mm
C	1.230 mm
D	528 mm
E	640 mm
F	65 mm
G	590 mm

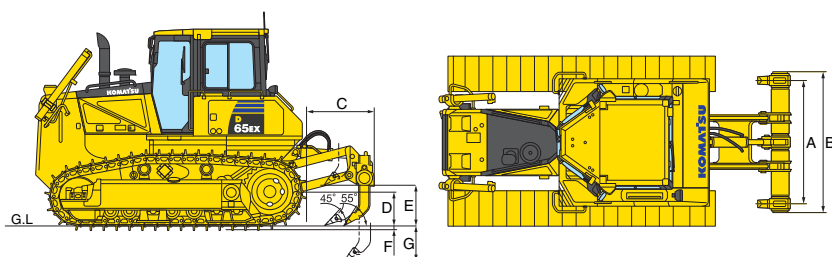

## OPERATING WEIGHT (APPR.)

Including blade and ripper (EX/WX), steel cab, ROPS, hydraulic control unit, operator, standard equipment, rated capacity of lubricant, coolant, and full fuel tank.

D65EX-17 with Sigmodozer®.....	22.070 kg
D65EX-17 with INPAT .....	22.620 kg
D65WX-17 with Sigmodozer®.....	22.660 kg
D65WX-17 with INPAT .....	23.520 kg
D65PX-17 with straight tilt.....	21.480 kg
D65PX-17 with INPAT .....	22.990 kg

## HYDRAULIC SYSTEM

Type .....CLSS (closed-centre load sensing system)  
 All spool valves externally mounted beside the hydraulic tank.  
 Main pump ..... Variable displacement piston pump  
 Maximum pump flow.....248 ltr/min  
 Relief valve setting .....285 kg/cm<sup>2</sup>

## NUMBER OF CYLINDERS x BORE

Type of blade	Sigmodozer®	Straight tilt	INPAT
Blade lift	2 x 85 mm	2 x 85 mm	2 x 90 mm
Blade tilt	-	1 x 125 mm	1 x 130 mm
Blade tilt/pitch	2 x 125 mm	-	-
Blade angle	-	-	2 x 110 mm

## RIPPER EQUIPMENT

Multishank ripper

Type ..... Hydraulically controlled parallelogram ripper  
 No. of shanks .....3  
 Weight (including hydraulic control unit) ..... 1.770 kg  
 Beam length .....2.170 mm  
 Maximum lift above ground.....640 mm  
 Maximum digging depth .....595 mm  
 Ripper cylinder .....1 x 125 mm

## DIMENSIONS

	D65EX-17 Sigmadozer®	D65WX-17 Sigmadozer®	D65PX-17 Straight tilt
A	5.490 mm	5.500 mm	5.680 mm
B	1.880 mm	2.050 mm	2.050 mm
C	3.155 mm	3.155 mm	3.155 mm
D	3.080 mm	3.080 mm	3.080 mm
E	2.970 mm	2.970 mm	3.275 mm
F	610 mm	760 mm	915 mm
G	65 mm	65 mm	65 mm
H	3.410 mm	3.580 mm	3.970 mm

Ground clearance 415 mm (+ 65 mm grouser height)

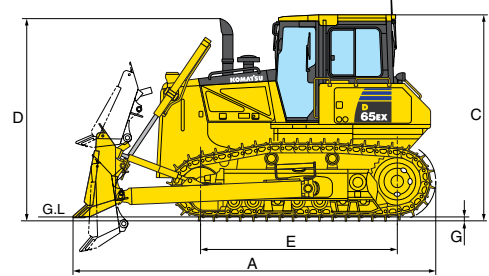
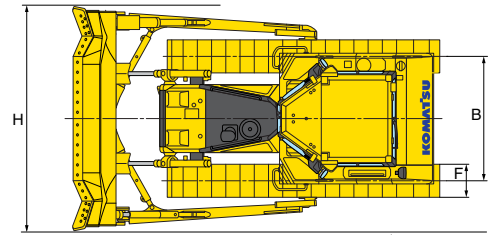
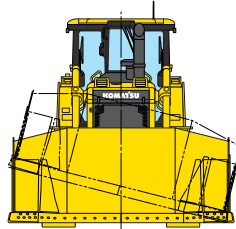

## DIMENSIONS

	D65EX-17 INPAT	D65WX-17 INPAT	D65PX-17 INPAT
A	5.790 mm	5.790 mm	5.790 mm
B	2.050 mm	2.230 mm	2.230 mm
C	3.155 mm	3.155 mm	3.155 mm
D	3.080 mm	3.080 mm	3.080 mm
E	2.970 mm	2.970 mm	3.275 mm
F	560 mm	760 mm	760 mm
G	65 mm	65 mm	65 mm
H	3.545 mm	3.670 mm	3.670 mm
H*	–	3.000 mm	3.000 mm

Ground clearance 415 mm (+ 65 mm grouser height)

\* Transport width with foldable INPAT blade

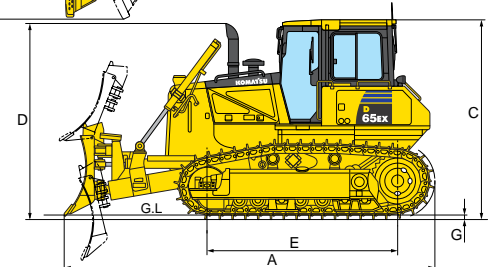
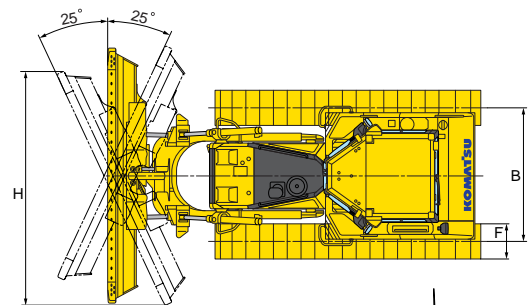
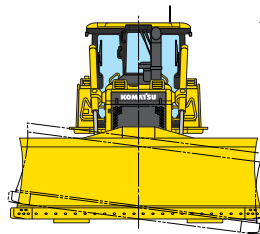

## DOZER EQUIPMENT

	Overall length with blade	Blade capacity	Blade width × height	Max. lift above ground	Max. drop below ground	Max. tilt adjustment	Additional weight
D65EX-17 Sigmadozer®	5.490 mm	5,61 m³	3.410 × 1.425 mm	1.135 mm	500 mm	870 mm	2.440 kg
D65EX-17 INPAT	5.790 mm	4,25 m³	3.870 × 1.235 mm	1.170 mm	695 mm	500 mm	2.960 kg
D65WX-17 Sigmadozer®	5.500 mm	5,90 m³	3.580 × 1.425 mm	1.135 mm	500 mm	770 mm	2.550 kg
D65WX-17 INPAT	5.790 mm	4,42 m³	4.010 × 1.235 mm	1.170 mm	695 mm	520 mm	* 2.990 kg
D65PX-17 Straight tilt	5.680 mm	3,69 m³	3.970 × 1.100 mm	1.130 mm	535 mm	890 mm	2.100 kg
D65PX-17 INPAT	5.790 mm	4,42 m³	4.010 × 1.235 mm	1.170 mm	695 mm	520 mm	* 2.990 kg

Blade capacities are based on the SAE recommended practice J1265.

\* Foldable INPAT blade (WX/PX): additional weight + 330 kg

# Crawler Dozer

## D65EX/WX/PX-17

### Standard and Optional Equipment

#### ENGINE AND RELATED PARTS

Komatsu SAA6D114E-5 Common rail direct injection diesel engine	●
EU Stage IIIB/EPA Tier 4 interim compliant	
Locks, filter caps and covers	●
Intake pipe with precleaner	●
Radiator reserve tank	●
Heavy-duty radiator mask	●
Fuel tank inlet strainer	●
Starter motor 24 V/7,5 kW	●
Alternator 24 V/60 A	●
Batteries 2 × 12 V/200 Ah	●
Gull wing engine side covers	●
Cooling fan, hydrostatic driven	●
Starter motor 24 V/11 kW	○
Alternator 24 V/90 A	○

#### HYDRAULIC SYSTEM

Hydraulics for dozing blades	●
Hydraulics for ripper (EX/WX)	●
Mono lever blade control	●
Hydraulics for ripper (field installation kit)	○

#### TRANSMISSION AND BRAKES

Palm lever steering control (PCCS)	●
HSS hydrostatic steering system	●
Decelerator pedal	●
Automatic transmission	●
Torque converter with automatic lock-up function	●
Damper	●

#### SERVICE AND MAINTENANCE

Dry type air cleaner, double element with dust indicator and evacuator	●
Large TFT colour monitor panel	●
Water separator	●
KOMTRAX™ - Komatsu wireless monitoring system	●
Tool kit	●

#### CABIN

Heated air suspension seat: fabric, reclining, high backrest, turnable	●
2 point seat belt with visible reminder	●
Headrest	●
High mount footrest	●
Automatic climate control system	●
Radio	●
Fenders	●
Sun visor, rear side	●
Cup holder	●
Lunch box holder	●
Wiper front and rear window	●
Wipers doors	●
Heated rear window (hot air)	●

#### SAFETY EQUIPMENT

Back-up alarm	●
Warning horn	●
Steel cab, meets ISO 3449 FOPS and ISO 3471, SAE J1040, APR88 ROPS standards	●
Rear-view mirror (inside cab)	●
Rear view camera system	●
Fire extinguisher	○

#### ATTACHMENTS

Shovel holder	●
Rear counterweight with hitch (EX/WX with INPAT blade) (not with ripper)	●
Hitch (EX/WX with Sigmadozer® blade)	●
Front pull hook	●
Rigid drawbar	○

#### LIGHTING SYSTEM

Working lights: 4 front and 2 rear lights	●
Additional working light, rear	●
Ripper working light	○

#### UNDERCARRIAGE

PLUS link assembly	●
Single grouser heavy-duty shoes:	
Sigmadozer® blade (EX): 610 mm	
Sigmadozer® blade (WX): 760 mm	
Straight tilt blade (PX): 915 mm	●
INPAT blade (EX): 560 mm	
INPAT blade (WX): 760 mm	
INPAT blade (PX): 760 mm	
Track roller guard, centre and end sections	●
Segmented sprockets	●
Fixed track rollers	●
Hydraulic track adjusters	●
Underguards, oil pan and transmission	●
Single grouser heavy-duty shoes:	
Sigmadozer® blade (EX): 510 mm, 560 mm, 660 mm	○
INPAT blade (EX): 510 mm	
Full length track roller guard (EX/WX)	○

#### DOZER EQUIPMENT

Straight tilt blade 3,69 m³ (PX)	○
Sigmadozer® blade, with pitch function, single tilt 5,61 m³ (EX)	○
Sigmadozer® blade, with pitch function, single tilt 5,9 m³ (WX)	○
INPAT blade 4,25 m³ with mechanical pitch (EX)	○
INPAT blade 4,42 m³ with mechanical pitch (WX)	○
INPAT blade 4,42 m³ with mechanical pitch (PX)	○
Foldable INPAT blade 4,42 m³ with mechanical pitch (WX/PX) (WX with ripper only)	○
Multishank ripper (EX/WX)	○

Further equipment on request

- standard equipment
- optional equipment

Your Komatsu partner:

# KOMATSU

**Komatsu Europe  
International NV**

Mechelsesteenweg 586  
B-1800 VILVOORDE (BELGIUM)  
Tel. +32-2-255 24 11  
Fax +32-2-252 19 81  
[www.komatsu.eu](http://www.komatsu.eu)

EESS019900 09/2011

Materials and specifications are subject to change without notice.

**KOMATSU** is a trademark of Komatsu Ltd. Japan.