

KOMATSU

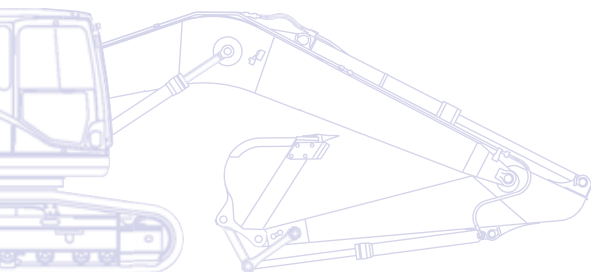

Hydraulic Excavator **PC700LC-8**



ENGINE POWER
323 kW / 433 HP @ 1.800 rpm

OPERATING WEIGHT
65.640 - 67.100 kg

BUCKET CAPACITY
max. 5,58 m³

Walk-Around

The Komatsu Dash 8 crawler excavators set new worldwide standards for quarry & mining equipment. Operator safety and comfort is a focal point in their design, and their outstanding performance and specifications will contribute directly to the success of your business. These powerful and robust machines are designed to stand up to the hardest working conditions while still maintaining maximum productivity. Safely rely on Komatsu's 80 years of experience and commitment to quality and durability: your Dash 8 crawler excavator will quickly become your number one business partner.

Powerful and environmentally friendly

- Low consumption ecot3 engine
- Hydraulic drive radiator cooling fan
- Less ambient noise
- Eco-gauge and idle caution
- Selectable working modes

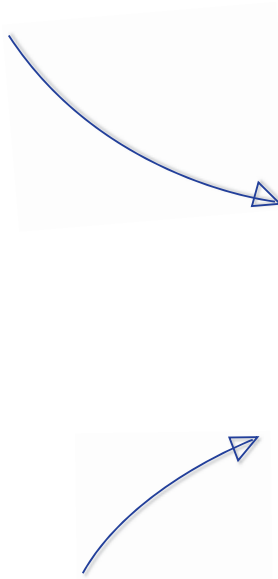

Maximum productivity

- Powerful digging force
- PowerMax
- Lifting mode
- Two-mode boom control
- Swing priority mode



PC700-8

ENGINE POWER
323 kW / 433 HP @ 1.800 rpm

OPERATING WEIGHT
65.640 - 67.100 kg

BUCKET CAPACITY
max. 5,58 m³

Highest safety standards

- Safe SpaceCab™
- Rear view camera
- Optimal jobsite safety
- Safe access, easy maintenance
- Laminated front screen

First-class operator comfort

- Wide, spacious cab
- Low noise design
- Low vibration levels
- Pressurised cab
- Large, widescreen TFT monitor panel

KOMTRAX

Komatsu wireless
monitoring system

Quality you can rely on

- Reliable and efficient
- High strength booms and arms
- High pressure in-line filtration
- Komatsu-quality components
- Rugged design



Maximum Productivity

Powerful digging force

Thanks to the high engine output and an optimised hydraulic system, the PC700-8 delivers a powerful bucket digging force of up to 362 kN (37 tonnes) at PowerMax and an arm crowd force of up to 293 kN (30 tonnes) at PowerMax.

PowerMax

The PC700-8 is now equipped with the one-touch PowerMax function that gives you maximum digging force when you need it most. It increases standard digging force by almost 10% and automatically switches off after 8 seconds to conserve fuel.

Swing priority mode

A twin swing motor system provides excellent swing performance, with high speed and strong braking power. The swing priority setting allows using the same smooth motion for either 180° or 90° loading operations. By altering the oil flow, the operator selects either boom or swing as the priority for increased production.

Lifting mode

For fine control work or for heavy lifting applications, the operator can select the lifting mode to gain 17% more lifting force on the boom.

Two-mode boom control

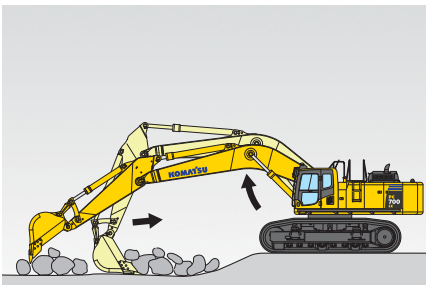

Smooth mode
Boom floats upward, reducing lifting of machine front. This facilitates gathering blasted rock and scraping down operations.

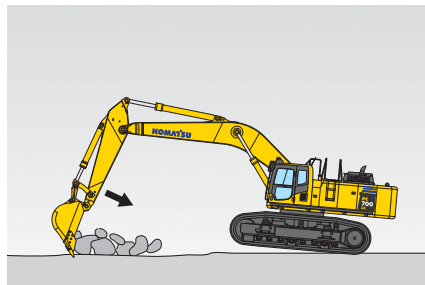

Power mode
Boom pushing force is increased, ditch digging and box digging operation on hard ground are improved.





Powerful and Environmentally Friendly

Low consumption ecot3 engine

Designed and manufactured by Komatsu, the SAA6D140E-5 engine provides high torque, a better performance at low speed, and low fuel consumption. With direct fuel injection, turbocharger, common rail air-to-air aftercooler and cooled EGR system, productivity and fuel efficiency are maximized. The Komatsu SAA6D140E-5 engine is certified for EU Stage IIIA and EPA Tier III emission regulations.

Exceptional drawbar pull and steering force

Regardless of the selected travel speed, the final drives automatically compensate for the load and give maximum driving force whenever needed. As a result, the PC700-8 generates exceptional drawbar pull and steering force, giving smooth, confident and safe machine movement.

Eco-gauge and idle caution

The unique ECO-gauge helps the operator reduce emissions and fuel consumption for environmentally friendly and energy saving operations. And to further avoid wasting fuel when the machine is not actually working, a standard-fit idle caution is displayed if the engine idles for 5 minutes or more.

Hydraulic drive radiator cooling fan

The engine cooling fan rotation speed is electronically controlled and depends on the engine coolant and the hydraulic oil temperatures: the higher the temperature, the faster the fan will turn. This system increases fuel efficiency, reduces the operating noise levels and requires less horsepower than belt driven fans.

Less ambient noise

The PC700-8 is an exceptionally powerful machine that maintains low operating noise levels. In addition to the electronically-controlled variable-speed fan drive, external noise levels are further reduced to meet EU Stage 2 noise regulations by a low-noise glass wool furnished muffler with cover, a hybrid fan, and low-noise components.



Komatsu SAA6D140E-5



Variable speed fan



Eco-gauge





Selectable working modes

The selectable “Power” or “Economy” modes are designed to match the engine speed, pump speed and system pressure to the current application. They give the operator the flexibility to match the equipment performance to the job at hand. The Economy mode has 4 stages, for an optimum combination of economy and production, while Power Modes can be switched to reduce fuel consumption where maximum breakout force is not needed.



First-Class Operator Comfort

Wide spacious cab

The wide and spacious cab includes a newly designed heated air suspension seat with a high backrest. The seat height and longitudinal inclination are easily adjusted with a pull-up lever. You can also set the operational posture of the armrest and the position of the console or recline the seat all the way and place it into a fully flat state with the headrest attached.

Pressurised cab

An automatic air conditioner, an air filter and a positive internal air pressure (60 Pa) combine to prevent external dust from entering the cab.

Low noise design

Komatsu Dash 8 crawler excavators feature the lowest in-class external noise levels and are especially well-suited for work in confined spaces or urban areas. Reduced fan speed, a large capacity radiator, and the optimal usage of sound insulation and of sound absorbing materials help to make noise levels inside Dash 8 excavators comparable to those inside an executive car.

Cab damper mounting

The built-in stability of the Komatsu PC700-8, combined with a highly rigid deck and a sprung multi-layer viscous mount system, drastically reduces vibration levels for the operator.



Automatic air conditioner



Storage compartment



3 button lever





Large, widescreen TFT monitor

To enable safe, accurate and smooth work, the user friendly monitor is the highly intuitive user interface for the machine's Equipment Management and Monitoring System (EMMS). Multilingual and with all essential information available at a glance, it features simple and easy to operate switches and multifunction keys that provide the operator with fingertip access to a wide range of functions and operating information.



Highest Safety Standards

Safe SpaceCab™

Specifically designed for Komatsu excavators, the Dash 8 cab has a tubular steel frame. It provides very high shock absorbency, impact resistance and durability. The seat belt is designed to keep the operator in the safety zone of the cab in the event of a roll-over. At your request, the Komatsu PC700-8 can also be fitted with an ISO 10262 Level 2 Falling Object Protective System (FOPS).

Safe and easy maintenance

Thermal guards are placed around high temperature parts of the engine. The fan belt and pulleys are well protected and in case of damage, fire risk is reduced by a pump/engine partition that prevents hydraulic oil from spraying onto the engine.

Safe access

A wide catwalk and large handrails give safe and easy access to the cab and to maintenance check points. Very durable anti-slip plates – with additional high friction covering – maintain long term traction performance.

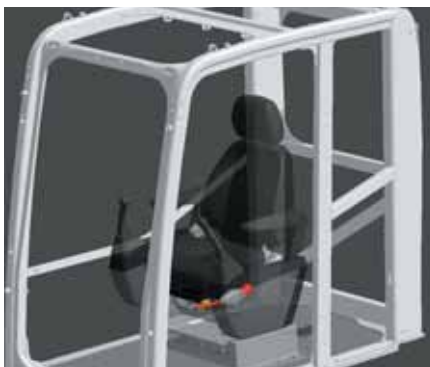

Safe SpaceCab™

Excellent visibility

The PC700-8's large capacity cab and increased glass area provide superb front visibility. Large mirrors on both sides ensure that machine visibility meets the latest ISO standards. Additional work lamps and a rotating beacon are fitted as standard, further enhancing safety.

Laminated front screen

The front screen of the PC700-8 is made of laminated glass, for enhanced protection against chips produced by rock breaking work. The single-piece design offers an uninterrupted view of the working area.



Step light with timer



Standard rear view camera





Quality You Can Rely On

Rugged design

The undercarriage of the PC700-8 is specifically designed to cope with the heavy forces to be found in hard quarry operations. With a wide range of heavy duty double grouser track shoes and a number of different roller guard options, the moving parts of the undercarriage are strongly shielded against damage from rocks, while traction force and ground pressure may be optimized for your particular site.

High strength boom and arm

Thanks to the large cross-sectional structure made with high tensile strength steel and a thick plate and partition wall, the boom and arm provide excellent durability and are highly resistant to bending and twisting. Highly durable rubbing strips on the underside of the arm protect the structure from any material that might fall from the bucket. The reinforced short boom and arm specification allows to increase the bucket capacity.

Reliable and efficient

Productivity is the key to success – all major components of the PC700-8 are designed and manufactured by Komatsu. All essential functions are perfectly matched for a highly reliable and productive machine.

Komatsu-quality components

With the latest computer design techniques and a thorough test programme, Komatsu's global know-how produces machines that are designed, manufactured and tested to meet your highest standards.

High pressure in-line filtration

The PC700-8 has the most extensive filtration system available, providing in-line filters as standard equipment. An in-line filter in the outlet port of each main hydraulic pump reduces failure caused by contamination.



Sturdy travel motor guards



Komatsu bucket with Kmax teeth



Full length track roller guards (optional)



Komatsu Wireless Monitoring System

The easy way to higher productivity

KOMTRAX™ is the latest in wireless monitoring technology. It delivers insightful and cost saving information about your fleet and equipment and offers you a wealth of information to facilitate peak machine performance. By creating a tightly integrated web of support it allows pro active and preventive maintenance and helps you to efficiently run a business.

Knowledge

You get quick answers to basic and critical questions about your machines - what they're doing, when they did it, where they're located, how they can be used more efficiently, and when they need to be serviced. Performance data is relayed by satellite from your machine to your computer and to your local Komatsu distributor - who's readily available for expert analysis and feedback.

Convenience

KOMTRAX™ helps to conveniently manage your fleet on the web, wherever you are. Data is analysed and packaged specifically for easy and intuitive viewing in maps, lists, graphs and charts. You can anticipate the type of service and parts your machines could require, or troubleshoot problems before Komatsu technicians arrive on site.



Power

The detailed information that KOMTRAX™ puts at your fingertips 24 hours a day, 7 days a week gives you the power to make better daily and long-term strategic decisions. You can anticipate problems, customize maintenance schedules, minimize downtime and keep your machines where they belong – working on the job site.

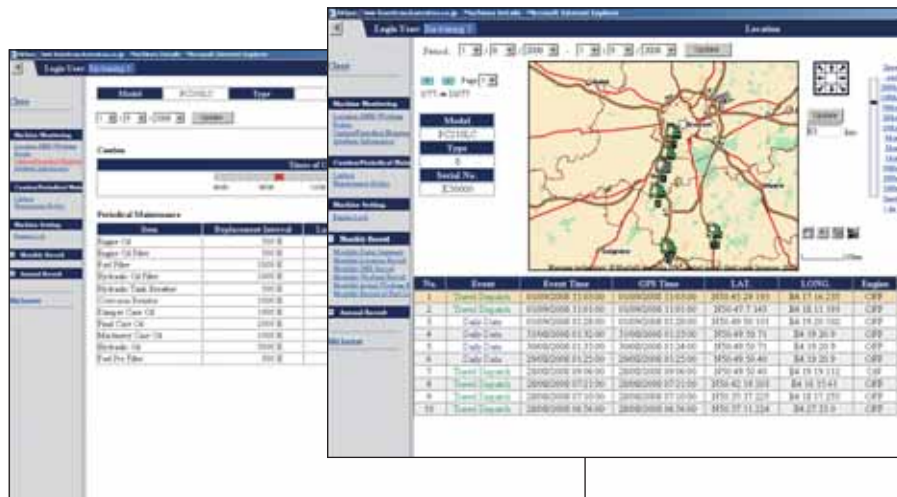

Through the web application, a variety of search parameters are available to quickly find information about specific machines based on key factors such as utilization rates, age, various notification messages, and more.

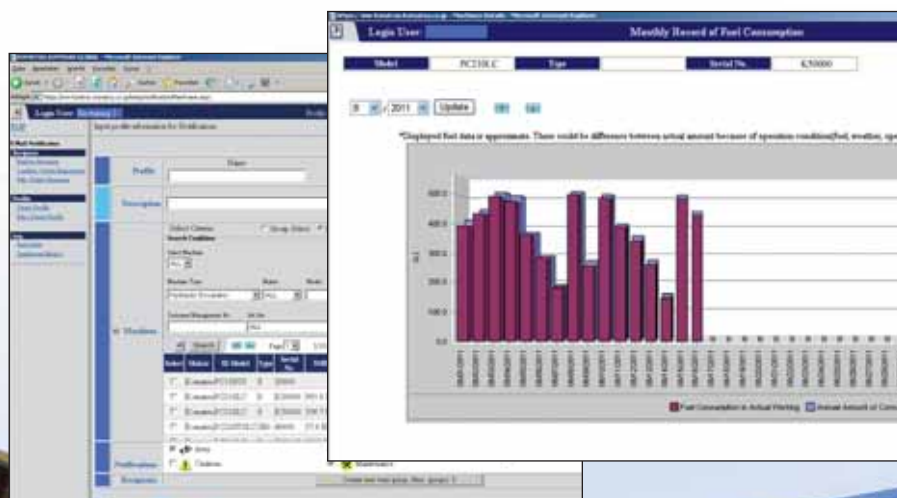

A simple chart shows the machine's fuel consumption and helps you to calculate total costs for a job site and conveniently schedule fuel deliveries.

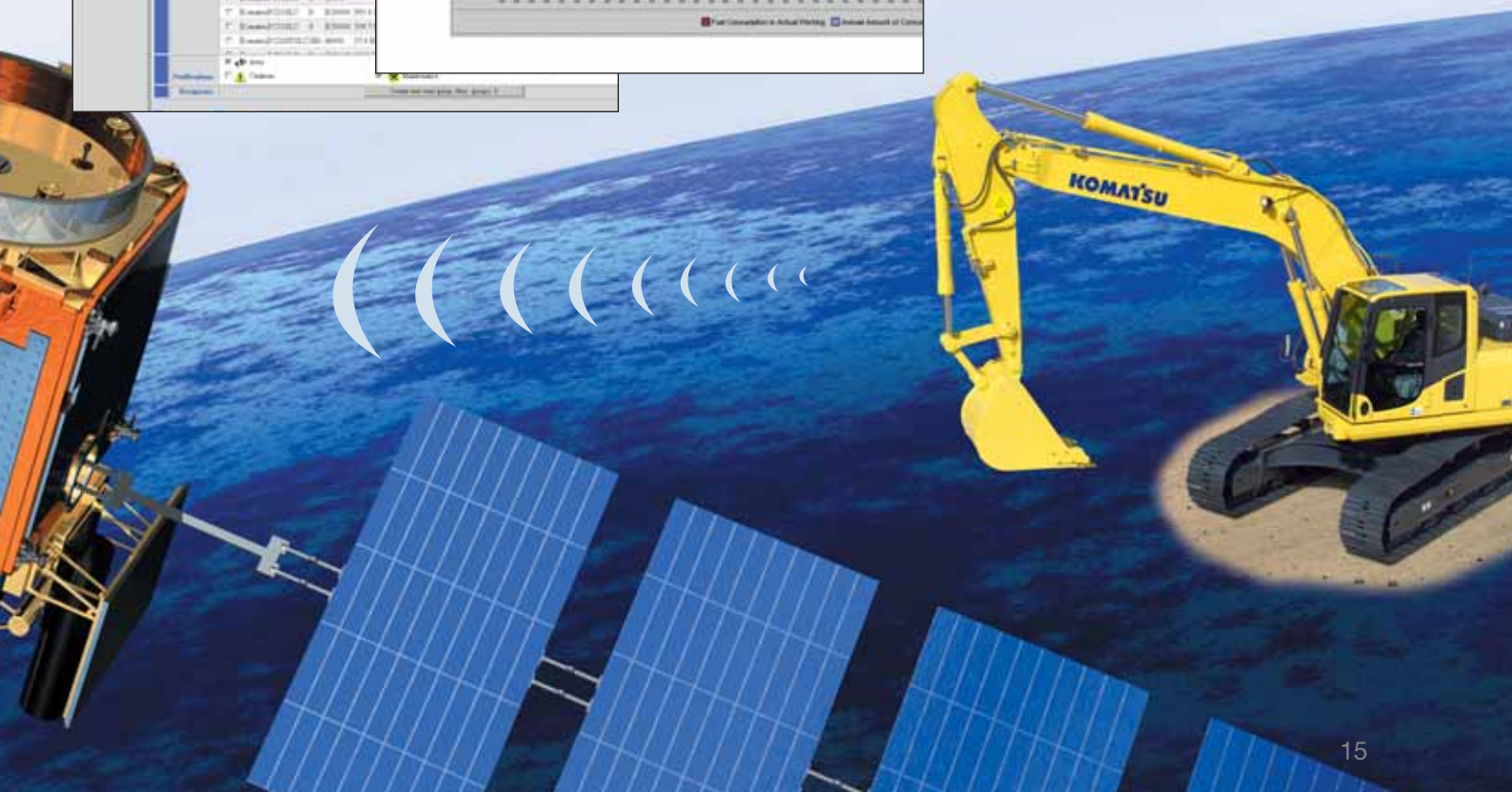

Easy Maintenance



Steps connected to the machine cab

For easy engine and maintenance, steps allow access from the left hand catwalk to the top of the machine.



Centralized service

Check points are concentrated on one side of the engine to facilitate daily servicing.



Motorised grease gun equipped with hose reel

Greasing is made easy with the electric motorised grease gun and indicator.

Easier radiator cleaning

Reverse rotation function of fan allows easier cleaning of the radiator.



5-step dust indicator

Informs of air cleaner clogging in 5 steps to warn of filter condition.



Long-life oil filters

The hydraulic oil filter uses high performance filtering material for long element replacement intervals, which significantly reduces maintenance costs.



Flexible warranty

When you purchase Komatsu equipment, you gain access to a broad range of programmes and services that have been designed to help you get the most from your investment. For example, Komatsu's Flexible Warranty Programme provides a range of extended warranty options on the machine and its components. These can be chosen to meet your individual needs and activities. This programme is designed to help reduce total operating costs.

ENGINE

Model Komatsu SAA6D140E-5
 Type Common rail direct injection, water-cooled, cooled EGR, turbocharged, after-cooled diesel

Engine power
 at rated engine speed 1.800 rpm
 ISO 14396 323 kW / 433 HP
 ISO 9249 (net engine power) 320 kW / 429 HP

No. of cylinders 6
 Bore × stroke 140 × 165 mm
 Displacement 15,24 ltr
 Fan drive type Hydraulic, reversible

HYDRAULIC SYSTEM

Type Open-center load-sensing system
 Additional circuits 1 additional circuit can be installed (7,3 m / 7,6 m boom only)

Number of selectable working modes 3
 Main pump Variable capacity piston pump
 Pumps for Boom, arm, bucket, swing, and travel circuits
 Maximum pump flow 2 × 410 ltr/min
 Fan drive pump Variable capacity piston pump

Hydraulic motors:
 Travel 2 × axial piston motor with parking brake
 Swing 2 × axial piston motor with swing holding brake

Relief valve settings
 Implement circuits 320 bar
 Travel circuit 350 bar
 Swing circuit 290 bar
 Pilot circuit 30 bar

UNDERCARRIAGE

Construction H-leg frame with box section track-frames
 Track assembly
 Type Fully sealed
 Shoes (each side) 47
 Tension Hydraulic

Rollers
 Track rollers (each side) 8
 Carrier rollers (each side) 3

SWING SYSTEM

Type Hydraulic motor
 Swing reduction Planetary gear
 Swing circle lubrication Grease-bathed
 Swing lock Oil disc brake
 Swing speed 8,3 rpm

DRIVES AND BRAKES

Steering control 2 levers with pedals
 Drive method Fully hydrostatic
 Travel motor Axial piston motor, in-shoe design
 Reduction system Planetary double reduction
 Max. drawbar pull 47.400 kg
 Gradeability 70%
 Max. travel speeds
 Lo / Hi 2,8 / 4,6 km/h
 Service brake Hydraulic lock
 Parking brake Oil disc brake

SERVICE REFILL CAPACITIES

Fuel tank 880 ltr
 Radiator 58 ltr
 Engine oil 40 ltr
 Swing drive 2 × 13 ltr
 Hydraulic tank 360 ltr
 Final drive (each side) 10 ltr

ENVIRONMENT

Engine emissions Fully complies with EU Stage IIIA and EPA Tier III exhaust emission regulations

Noise levels
 LwA external 108 dB(A) (2000/14/EC Stage 2)
 LpA operator ear 73 dB(A) (ISO 6396 dynamic test)

Vibration levels (EN 12096:1997)*
 Hand/arm ≤ 2,5 m/s² (uncertainty K = 1,06 m/s²)
 Body ≤ 0,5 m/s² (uncertainty K = 0,15 m/s²)

* for the purpose of risk assessment under directive 2002/44/EC, please refer to ISO/TR 25398:2006.

OPERATING WEIGHT (APPR.)

Work equipment	6,6 m boom / 2,9 m arm / 2.500 kg bucket		7,3 m boom / 3,5 m arm / 2.500 kg bucket		7,6 m boom / 3,5 m arm / 2.500 kg bucket	
	Operating weight	Ground pressure	Operating weight	Ground pressure	Operating weight	Ground pressure
Double grouser shoes						
610 mm	65.640 kg	1,08 kg/m ²	65.540 kg	1,08 kg/m ²	65.700 kg	1,08 kg/m ²
710 mm	66.330 kg	0,94 kg/m ²	66.230 kg	0,94 kg/m ²	66.390 kg	0,94 kg/m ²
810 mm	67.015 kg	0,83 kg/m ²	66.915 kg	0,83 kg/m ²	67.075 kg	0,83 kg/m ²
910 mm	67.040 kg	0,74 kg/m ²	66.940 kg	0,74 kg/m ²	67.100 kg	0,74 kg/m ²

Operating weight, including boom, arm, bucket, operator, lubricant, coolant, full fuel tank and the standard equipment.

Dimensions & Performance Figures

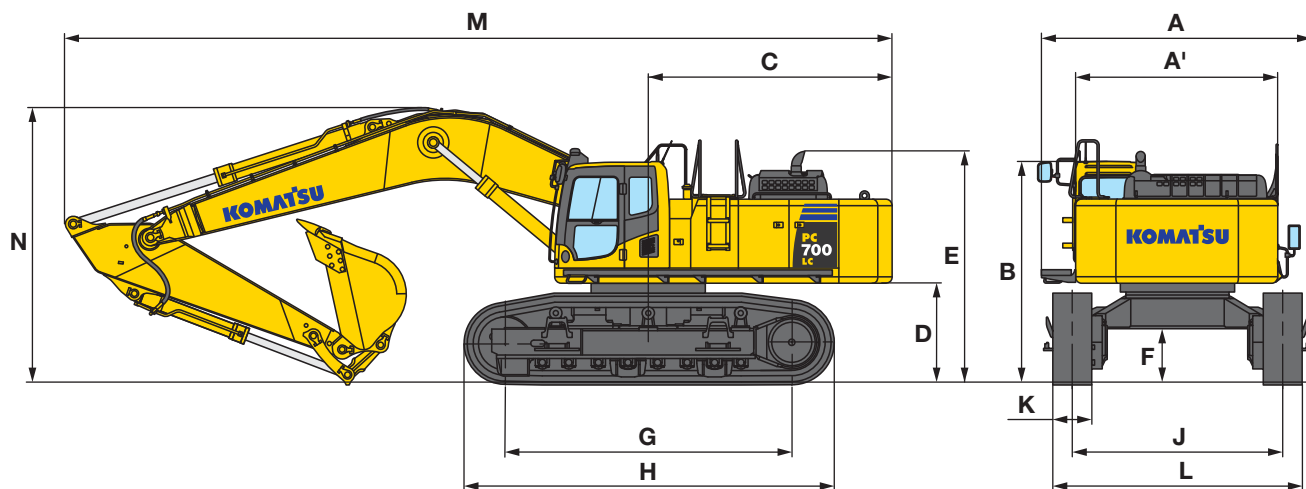

MODEL	PC700LC-8		
Boom length	6,6 m	7,3 m	7,6 m
Arm length	2,9 m	3,5 m	3,5 m
A Overall width of upper structure (incl. catwalk)	4.290 mm	4.290 mm	4.290 mm
A' Machine cab width	3.170 mm	3.170 mm	3.170 mm
B Overall height of cab (incl. OPG)	3.595* mm	3.595* mm	3.475 mm
C Tail swing radius	3.950 mm	3.950 mm	3.950 mm
D Clearance under counterweight	1.550 mm	1.550 mm	1.550 mm
E Machine tail height (to top of exhaust pipe)	3.620 mm	3.620 mm	3.620 mm
F Ground clearance	830 mm	830 mm	830 mm
G Tumbler center distance	4.500 mm	4.500 mm	4.500 mm
H Track length	5.810 mm	5.810 mm	5.810 mm
J Track gauge (working position)	3.300 mm	3.300 mm	3.300 mm
K Track shoe width	610, 710, 810, 910 mm	610, 710, 810, 910 mm	610, 710, 810, 910 mm
L Overall track width with 610 mm shoes	3.910 mm	3.910 mm	3.910 mm
Overall track width with 710 mm shoes	4.010 mm	4.010 mm	4.010 mm
Overall track width with 810 mm shoes	4.110 mm	4.110 mm	4.110 mm
Overall track width with 910 mm shoes	4.210 mm	4.210 mm	4.210 mm
Grouser height	50 mm	50 mm	50 mm
Track gauge (when retracted)	2.590 mm	2.590 mm	2.590 mm
M Overall length	11.990 mm	12.580 mm	12.960 mm
N Overall height (to top of boom)	4.670 mm	4.280 mm	4.350 mm

MAX. BUCKET CAPACITY AND WEIGHT

Arm length	2,9 m (6,6 m boom)		3,5 m (7,3 m boom)		3,5 m (7,6 m boom)	
Material weight up to 1,2 t/m ³	5,58 m ³	3.925 kg	4,28 m ³	3.625 kg	4,05 m ³	3.250 kg
Material weight up to 1,5 t/m ³	4,66 m ³	3.650 kg	3,59 m ³	3.375 kg	3,24 m ³	2.600 kg
Material weight up to 1,8 t/m ³	4,00 m ³	3.425 kg	3,10 m ³	3.200 kg	2,70 m ³	2.175 kg
Max. bucket width	2.000 mm		1.780 mm		1.600 mm	

Max. capacity and weight have been calculated according to ISO 10567:2007.

Please consult with your distributor for the correct selection of buckets and attachments to suit the application.

UPPER STRUCTURE + UNDERCARRIAGE

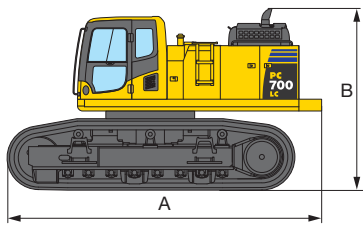

PC700LC-8		
A	Length	6.490 mm
B	Height	3.665 mm
	Overall width (610, 710 mm shoes)	3.490 mm
	Overall width (810, 910 mm shoes)	3.810 mm
	Weight	40.500 kg

UPPER STRUCTURE

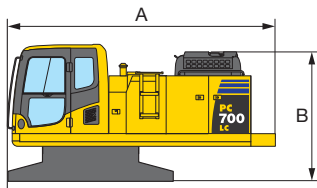

PC700LC-8		
A	Length	5.065 mm
B	Total height	2.765 mm
	Overall width	3.170 mm
	Weight	17.500 kg

UNDERCARRIAGE

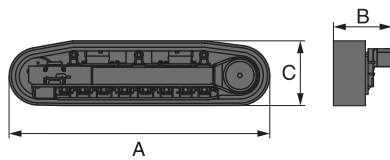

PC700LC-8		
	Quantity	2
A	Length	5.810 mm
B	Overall width	980 mm
C	Height	1.440 mm
	Weight	22.000 kg (2 × 11.000 kg)

Boom

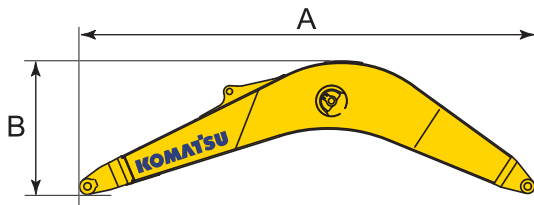

BOOM LENGTH	6,6 m	7,3 m	7,6 m
A Length	6.870 mm	7.550 mm	7.930 mm
B Height	2.090 mm	2.010 mm	2.010 mm
	Overall width	1.050 mm	1.050 mm
	Weight	4.810 kg	4.710 kg

Arm

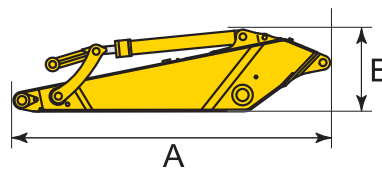

ARM LENGTH	2,9 m	3,5 m
A Length	4.230 mm	4.870 mm
B Height	1.490 mm	1.210 mm
	Overall width	460 mm
	Weight	3.510 kg

COUNTERWEIGHT

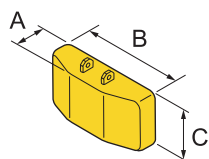

PC700LC-8		
A	Width	830 mm
B	Length	3.170 mm
C	Height	1.320 mm
	Weight	10.750 kg

CYLINDERS

BOOM CYLINDER

A	Length	2.670 mm
	Weight	1.000 kg (2 × 500 kg)

ARM CYLINDER

A	Length	3.110 mm
	Weight	730 kg

Working Range

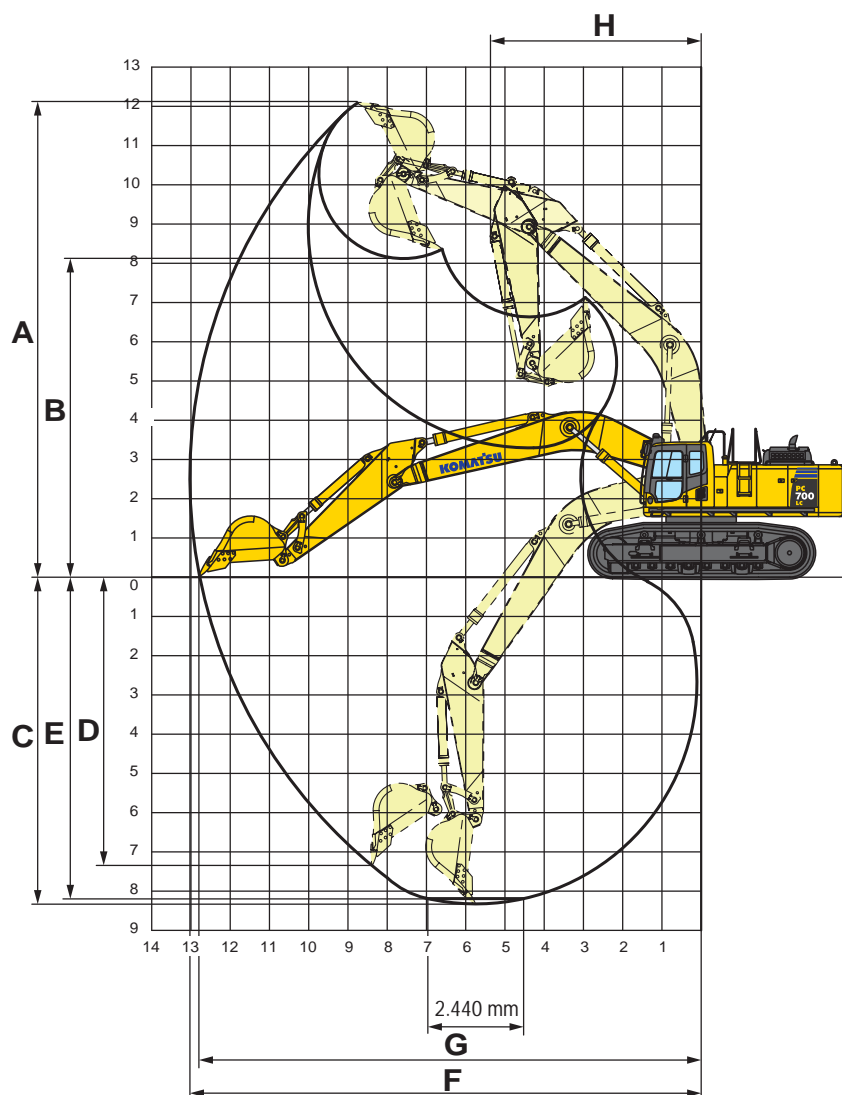

MONO BOOM

Boom length	6,6 m	7,3 m	7,6 m
Arm length	2,9 m	3,5 m	3,5 m
A Max. digging height	11.350 mm	11.680 mm	12.085 mm
B Max. dumping height	7.360 mm	7.810 mm	8.120 mm
C Max. digging depth	6.910 mm	8.010 mm	8.325 mm
D Max. vertical wall digging depth	5.470 mm	6.480 mm	7.340 mm
E Max. digging depth of cut for 2,44 m level	6.765 mm	7.880 mm	8.190 mm
F Max. digging reach	11.585 mm	12.640 mm	13.030 mm
G Max. digging reach at ground level	11.295 mm	12.380 mm	12.785 mm
H Min. swing radius	4.670 mm	5.090 mm	5.370 mm

BUCKET AND ARM FORCE (ISO)

Arm length (boom length)	2,9 m (6,6 m)	3,5 m (7,3 m)
Bucket digging force	34.300 kg	30.000 kg
Bucket digging force at PowerMax	36.900 kg	32.300 kg
Arm crowd force	27.700 kg	23.300 kg
Arm crowd force at PowerMax	29.900 kg	25.100 kg

BOOM LENGTH 6,6 M

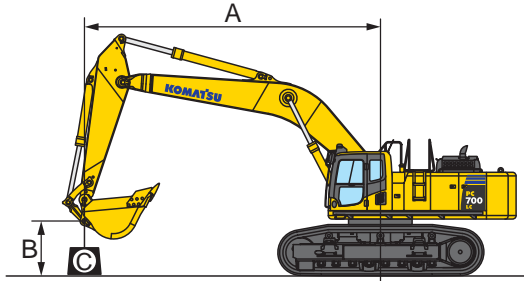

A – Reach from swing centre

B – Bucket hook height

C – Lifting capacities

– Rating over front

– Rating over side

– Rating at maximum reach

With 610 mm shoes

Arm length	A		9,0 m		7,5 m		6,0 m		4,5 m		3,0 m		
	B												
	9,1 m	kg *9.700	*9.700										
	7,6 m	kg *9.080	*9.080			*11.270	*11.270						
	6,1 m	kg *8.960	*8.960	*8.780	*8.780	*11.590	*11.590						
	4,6 m	kg *9.200	*9.200	*11.040	11.000	*12.600	*12.600	*15.350	*15.350	*19.960	*19.960		
	3,0 m	kg *9.810	9.460	*11.590	10.640	*13.930	*13.930	*18.000	*18.000	*24.410	*24.410		
	1,5 m	kg *10.790	9.280	*12.010	10.320	*14.900	14.100	*19.670	*19.670	*26.870	*26.870		
	0,0 m	kg *11.370	9.570	*11.990	10.100	*15.250	13.690	*20.040	19.650	*26.580	*26.580		
	-1,5 m	kg *11.480	10.450	*11.030	10.060	*14.870	13.490	*19.620	*19.360	*26.540	*26.540	*18.830	*18.830
	-3,0 m	kg *11.370	*11.370			*13.090	*13.090	*17.780	*17.780	*23.560	*23.560	*22.590	*22.590
	-4,6 m	kg *10.470	*10.470					*13.340	*13.340	*18.080	*18.080	*22.890	*22.890
	-6,1 m	kg											
	Lifting mode: ON 	9,1 m	kg *11.830	*11.830									
7,6 m		kg *11.110	*11.110			*14.110	*14.110						
6,1 m		kg *10.970	*10.970	*10.770	*10.770	*14.530	*14.530						
4,6 m		kg *11.240	10.170	*13.990	11.000	*15.800	15.330	*19.030	*19.030	*24.460	*24.460		
3,0 m		kg *11.950	9.460	14.500	10.640	*17.460	14.600	*22.320	21.350	*30.100	*30.100		
1,5 m		kg 12.750	9.280	14.150	10.320	*18.690	14.100	*24.430	20.320	*27.300	*27.300		
0,0 m		kg 13.180	9.570	13.920	10.100	18.880	13.690	*24.920	19.650	*26.580	*26.580		
-1,5 m		kg 14.400	10.450	13.880	10.060	*18.660	13.490	*24.460	19.360	*32.840	*31.600	*22.520	*22.520
-3,0 m		kg *14.580	12.320			*16.640	13.580	*22.300	19.480	*29.330	*29.330	*27.240	*27.240
-4,6 m		kg *13.600	*13.600					*17.050	*17.050	*22.840	*22.840	*28.910	*28.910
-6,1 m		kg											

* Load is limited by hydraulic capacity rather than tipping.

Ratings are based on SAE Standard No. J1097.

Rated loads do not exceed 87% of hydraulic lift capacity or 75% of tipping load.

Lifting capacity table is published for guidance only, the machine is not intended for use as a crane.

Lifting capacities are stated in kg, on the tip of the arm, for machine on firm, level supporting surface.

Lifting Capacity

BOOM LENGTH 7,3 M

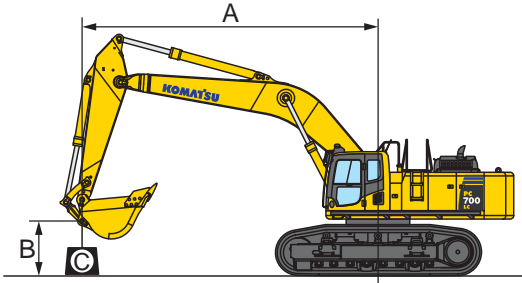

A – Reach from swing centre

B – Bucket hook height

C – Lifting capacities

– Rating over front

– Rating over side

– Rating at maximum reach

With 610 mm shoes

Arm length	A		9,0 m		7,5 m		6,0 m		4,5 m		3,0 m		
	B												
	9,1 m	kg *6.500	*6.500										
	7,6 m	kg *6.300	*6.300	*8.000	*8.000								
	6,1 m	kg *6.350	*6.350	*9.550	*9.550	*10.500	*10.500						
	4,6 m	kg *6.650	*6.650	*10.150	*10.150	*11.750	*11.750	*14.500	*14.500	*19.900	*19.900		
	3,0 m	kg *7.200	*7.200	*11.000	10.800	*13.300	*13.300	*17.350	*17.350	*24.100	*24.100		
	1,5 m	kg *8.000	7.750	*11.650	10.400	*14.500	14.100	*19.250	*19.250	*21.300	*21.300		
	0,0 m	kg *9.200	7.900	*12.050	10.150	*15.150	13.650	*20.000	19.500	*14.600	*14.600		
	-1,5 m	kg *10.200	8.500	*11.900	10.000	*15.150	13.400	*19.850	19.200	*21.100	*21.100	*14.000	*14.000
	-3,0 m	kg *10.350	9.650	*10.900	10.000	*14.400	13.350	*18.750	*18.750	*24.750	*24.750	*19.650	*19.650
	-4,6 m	kg *10.350	*10.350			*12.100	*12.100	*16.150	*16.150	*21.000	*21.000	*27.400	*27.400
-6,1 m	kg *9.500	*9.500					*11.450	*11.450	*15.250	*15.250			
Lifting mode: ON 	9,1 m	kg *8.150	*8.150										
	7,6 m	kg *7.900	*7.900	*9.850	*9.850								
	6,1 m	kg *7.950	*7.950	*12.150	11.550	*13.200	*13.200						
	4,6 m	kg *8.300	*8.300	*12.900	11.200	*14.800	*14.800	*18.000	*18.000	*24.400	*24.400		
	3,0 m	kg *8.900	7.900	*13.950	10.800	*16.700	14.750	*21.550	21.050	*26.500	*26.500		
	1,5 m	kg *9.850	7.750	14.200	10.400	*18.200	14.100	*23.950	20.200	*23.400	*23.400		
	0,0 m	kg 10.950	7.900	13.950	10.150	18.800	13.650	*24.850	19.500	*17.800	*17.800		
	-1,5 m	kg 11.700	8.500	13.750	10.000	18.550	13.400	*24.750	19.200	*25.450	*25.450	*16.950	*16.950
	-3,0 m	kg 13.250	9.650	13.800	10.000	*18.150	13.350	*23.450	19.200	*30.700	*30.700	*23.750	*23.750
	-4,6 m	kg *13.350	12.100			*15.450	13.600	*20.350	*19.450	*26.250	*26.250	*33.500	*33.500
-6,1 m	kg *12.450	*12.450					*14.750	*14.750	*19.500	*19.500			

* Load is limited by hydraulic capacity rather than tipping.

Ratings are based on SAE Standard No. J1097.

Rated loads do not exceed 87% of hydraulic lift capacity or 75% of tipping load.

Lifting capacities are stated in kg, on the tip of the arm, for machine on firm, level supporting surface.

BOOM LENGTH 7,6 M

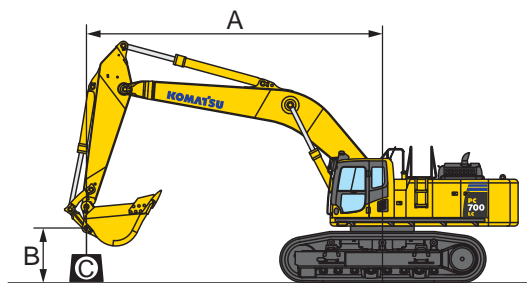

A – Reach from swing centre

B – Bucket hook height

C – Lifting capacities

– Rating over front

– Rating over side

– Rating at maximum reach

With 610 mm shoes

Arm length	A		9,0 m		7,5 m		6,0 m		4,5 m		3,0 m		
	B												
	9,1 m	kg *6.950	*6.950										
	7,6 m	kg *6.750	*6.750	*9.400	*9.400								
	6,1 m	kg *6.850	*6.850	*9.700	*9.700	*10.800	*10.800						
	4,6 m	kg *7.100	*7.100	*10.400	*10.400	*12.100	*12.100	*15.000	*15.000	*20.100	*20.100		
	3,0 m	kg *7.600	*7.600	*11.250	11.100	*13.600	*13.600	*17.850	*17.850				
	1,5 m	kg *8.300	7.550	*11.950	10.700	*14.800	14.300	*19.650	*19.650	*14.500	*14.500		
	0,0 m	kg *9.400	7.700	*12.350	10.400	*15.400	13.850	*20.200	19.500	*16.850	*16.850		
	-1,5 m	kg *10.000	8.200	*12.300	10.250	*15.450	13.600	*20.000	19.200	*16.550	*16.550	*11.950	*11.950
	-3,0 m	kg *10.150	9.150	*11.600	10.250	*14.800	13.550	*18.950	*18.950	*24.500	*24.500	*14.350	*14.350
	-4,6 m	kg *10.150	*10.150			*12.950	*12.950	*16.650	*16.650	*21.150	*21.150	*24.800	*24.800
-6,1 m	kg *9.500	*9.500			*8.550	*8.550	*12.800	*12.800	*16.300	*16.300			
Lifting mode: ON 	9,1 m	kg *8.550	*8.550										
	7,6 m	kg *8.350	*8.350	*11.850	*11.850								
	6,1 m	kg *8.450	*8.450	*12.250	11.950	*13.500	*13.500						
	4,6 m	kg *8.750	8.150	*13.100	11.550	*15.100	*15.100	*18.500	*18.500	*24.650	*24.650		
	3,0 m	kg *9.300	7.700	*14.150	11.100	*17.000	14.900	*22.100	21.250				
	1,5 m	kg *10.150	7.550	14.500	10.700	*18.500	14.300	*24.350	20.150	*17.400	*17.400		
	0,0 m	kg 10.550	7.700	14.200	10.400	18.950	13.850	*25.100	19.500	*20.150	*20.150		
	-1,5 m	kg 11.200	8.200	14.000	10.250	18.700	13.600	*24.850	19.200	*19.950	*19.950	*14.450	*14.450
	-3,0 m	kg 12.500	9.150	14.000	10.250	*18.600	13.550	*23.650	19.300	*30.400	*30.400	*17.400	*17.400
	-4,6 m	kg *13.000	11.150			*16.400	13.750	*20.900	19.600	*26.450	*26.450	*29.600	*29.600
-6,1 m	kg *12.350	*12.350			*11.150	*11.150	*16.350	*13.650	*20.650	*20.650			

* Load is limited by hydraulic capacity rather than tipping.

Ratings are based on SAE Standard No. J1097.

Rated loads do not exceed 87% of hydraulic lift capacity or 75% of tipping load.

Lifting capacities are stated in kg, on the tip of the arm, for machine on firm, level supporting surface.

Hydraulic Excavator

PC700LC-8

Standard and Optional Equipment

ENGINE

Komatsu SAA6D140E-5, 323 kW turbocharged common rail direct injection diesel engine, EU Stage IIIA compliant	●
Radiator & oil cooler with fly net	●
Automatic engine warm-up system	●
Engine overheat prevention system	●
Cooling fan: remote hydraulically driven variable speed, reversible	●
Auto-deceleration function	●
Engine ignition can be password secured on request	●
Alternator 24 V/90 A	●
Starter motor 24 V/11 kW	●
Batteries 2 × 12 V/240 Ah	●

HYDRAULIC SYSTEM

Electronic Open-centre load sensing (E-OLSS) hydraulic system	●
Pump and engine mutual control (PEMC) system	●
Working mode selection system (power mode, economy mode)	●
In-line filter for hydraulics	●
Adjustable PPC wrist control levers with 3 button controls for arm, boom, bucket and swing	●
Heavy lift mode	●
2 mode boom control	●
Additional hydraulic function (preparation), single acting (1 way flow) only (7,3 m / 7,6 m boom only)	○

UNDERCARRIAGE

Track frame undercovers	●
Track roller guards (1 per side)	●
LC undercarriage	●
610, 710, 810, 910 mm wide double grouser shoes	○
Extra additional track roller guard	○
Full length track roller guards	○

CABIN

Reinforced safety SpaceCab™; highly pressurised and tightly sealed hyper viscous mounted cab with tinted safety glass windows, large roof window with sun shade, one piece, fixed laminated front window, front window wiper with intermittent feature, sun roller blind, cigarette lighter, ashtray, luggage shelf, floor mat	●
Heated, high back air suspension seat with lumbar support, height adjustable arm rests and retractable seat belt	●
Automatic climate control system	●
12 Volt power supply	●
Radio	●
Lower wiper	○
Rain visor (not with OPG)	○

SERVICE AND MAINTENANCE

Automatic fuel line de-aeration	●
Double element type air cleaner with dust indicator and auto dust evacuator	●
KOMTRAX™ - Komatsu wireless monitoring system	●
Multi-function video compatible colour monitor with Equipment Management and Monitoring System (EMMS) and efficiency guidance	●
Toolkit and spare parts for first service	●

WORK EQUIPMENT

6,6 m mono boom	○
7,3 m mono boom	○
7,6 m mono boom	○
2,9 m; 3,5 m arms	○
Komatsu buckets	○

SAFETY EQUIPMENT

Lockable fuel cap and covers	●
Audible travel alarm	●
Machine cab handrails and catwalk	●
Step light with timer	●
Battery main switch	●
Rear view camera system	●
Boom safety valves (7,3 m / 7,6 m boom only)	●
Arm safety valves (7,3 m / 7,6 m boom only)	●
OPG Level II front guard (FOPS)	○
OPG Level II top guard (FOPS)	○

DRIVES AND BRAKES

Hydrostatic, 2-speed travel system with automatic shift and planetary triple reduction final drives, and hydraulic travel and oil disc parking brakes	●
PPC control levers and pedals for steering and travel	●

LIGHTING SYSTEM

Working lights: 2 cab roof (front), 1 boom, 2 revolving frame, beacon	●
---	---

OTHER EQUIPMENT

Remote greasing for swing circle and pins	●
Standard colour scheme and decals	●
Parts book and operator manual	●
Biodegradable oil for hydraulic system	○

Further equipment on request

- standard equipment
- optional equipment

Your Komatsu partner:

KOMATSU

**Komatsu Europe
International NV**
Mechelsesteenweg 586
B-1800 VILVOORDE (BELGIUM)
Tel. +32-2-255 24 11
Fax +32-2-252 19 81
www.komatsu.eu

UESS15301 08/2012

Materials and specifications are subject to change without notice.
KOMATSU is a trademark of Komatsu Ltd. Japan.