

# KOMATSU

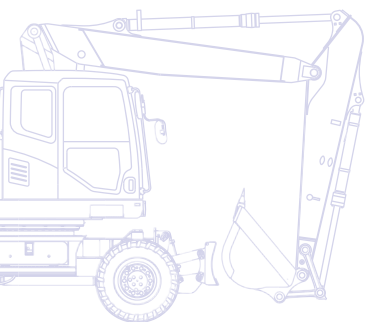

Hydraulic Wheeled Excavator

## PW180-10



**ENGINE POWER**  
123 kW / 165 HP @ 2.000 rpm

**OPERATING WEIGHT**  
16.680 - 18.930 kg

**BUCKET CAPACITY**  
max. 1,13 m<sup>3</sup>

# Walk-Around

The Komatsu PW180-10 wheeled excavator is expressly designed and built to stand up against the most demanding work environments in Europe. With all of the muscle and sophistication needed for a broad range of works, the EU Stage IIIB / EPA Tier 4 interim engine and advanced hydraulics make it an environmentally-friendly machine with increased power and a low fuel consumption that is reduced by up to 15% when travelling. The new cab is a comfortable and quiet work place, with improved ergonomics and an outstanding view. The PW180-10 gives you improved productivity, good stability, a high lifting capacity and simplified maintenance.

## Powerful and environmentally friendly

- Low consumption EU Stage IIIB/EPA Tier 4 interim engine
- More fuel-saving technology
- Excellent travel performance
- Komatsu integrated hydraulic system
- High lift capacity

## Total versatility

- Ideal for a wide range of applications
- Additional hydraulic circuit
- A wide choice of options





# PW180-10

**ENGINE POWER**  
123 kW / 165 HP @ 2.000 rpm

**OPERATING WEIGHT**  
16.680 - 18.930 kg

**BUCKET CAPACITY**  
max. 1,13 m<sup>3</sup>

## First-class operator comfort

- Newly designed SpaceCab™
- Air-suspended, heated seat
- Improved operator convenience
- Large, widescreen TFT monitor panel



## State of the art controls

- Proportional controls for attachments
- Easy operation
- 6 working modes
- Flexible and versatile

## Easy maintenance

- Simple and convenient service
- Easy radiator access
- Centralised greasing system
- Electric refuelling pump



Complimentary maintenance  
program for customers

**KOMTRAX**

Komatsu Wireless Monitoring  
System

# Total Versatility

## **Ideal for a wide range of applications**

Powerful and precise, the Komatsu PW180-10 is equipped to efficiently carry out any task your business requires. On big sites or small, for digging, trenching, landscaping or site preparation, the Komatsu original equipment hydraulic system always ensures maximum productivity and control.

## **Additional hydraulic circuit**

To allow the use of many attachments, such as buckets, breakers or clamshell buckets, an additional hydraulic circuit controlled by a sliding joystick button, is standard on the PW180-10. To further increase versatility and flexibility, a second optional auxiliary line and an optional hydraulic quick-coupler actuation are also available.

## **A wide choice of options**

With a choice of different styles of boom, arm and undercarriage attachments, you can configure the PW180-10 to match specific demands for transport, working envelope or duty. The excavator can for instance be equipped with a parallel-moving dozer blade that stabilizes the machine without damaging street surfaces. Extra hydraulic arrangements are available for every boom and arm configuration, to make sure that the PW180-10 always contributes strongly to your business.









# First-Class Operator Comfort

## Newly designed SpaceCab™

The all-new cab provides you with a comfortable and quiet work environment, and with an outstanding visibility of the job site. It is ROPS-certified, specifically designed by Komatsu for hydraulic excavators, and its reinforced pipe-structured framework is mounted on viscous damper mounts for low vibration levels. This redesigned cab offers ample storage space and better ergonomics. Unique features include switches that light up for safe and convenient night operation and a standard tilttable and telescopic steering wheel, which you can easily adjust to your height and sitting position.

## Air-suspended, heated seat

The high comfort air-suspended seat, with a heating function, lumbar support and multiple possibilities for adjustments, ensures the operator's well being during the entire working day. The seat and the side consoles can be adjusted individually to fit each operator's preference.



Newly designed SpaceCab™

## Improved operator convenience

With increased in-cab storage space, an auxiliary input (MP3 jack) and 12 V and 24 V power supply, the cab offers maximum convenience. The automatic air conditioner allows the operator to easily and precisely set the cab's atmosphere.



Auxiliary input (MP3 jack)

## Large, widescreen TFT monitor panel

To enable safe, accurate and smooth work, the user friendly monitor is the highly intuitive user interface for the machine's Equipment Management and Monitoring System (EMMS). Multilingual and with all essential information available at a glance, it features simple and easy-to-operate switches and multifunction keys that provide the operator with fingertip access to a wide range of functions and operating information.







# State of the Art Controls

## Proportional controls

The ergonomic joysticks with proportional controls were specially redesigned and developed for working with a wheeled excavator. They have horizontal sliders for the first attachment line – and for the second optional one – and offer safe and precise operation of attachments such as ditch cleaning buckets, sorting grapples, clam-shell buckets, tilt rotators and of many other hydraulic attachments that require very fine control.

## Easy operation

The Komatsu PW180-10 introduces a new operational concept that puts full control of the machine right at the operator's fingertips. A rear-view camera, undercarriage attachments and the manual axle lock can all be actuated by buttons on top of the operational levers. Without removing the hand from the right joystick, the operator can switch its function from boom operation to undercarriage control – for complete and precise control over the parallel dozer blade.

## 6 working modes

Power, Lifting, Breaker, Economy, Attachment Power and Attachment Economy modes are all available, ensuring that the PW180-10 delivers the power you need with minimised fuel usage. The Economy mode can be adjusted for an ideal balance between power and economy to match your work. The oil flow delivered to hydraulic attachments is adjustable directly on the class-leading wide screen monitor panel.

## Flexible and versatile

The PW180-10 is factory prepared for the use of any standard tilt rotator. In combination with the optional hydraulic quick-coupler actuation, it achieves a maximum of versatility in any application.









# Powerful and Environmentally Friendly

## New Komatsu engine technology

The powerful and fuel-efficient Komatsu SAA6D107E-2 engine in the PW180-10 delivers 123 kW/ 165 HP and is EU Stage IIIB/EPA Tier 4 interim certified. To maximise power, fuel efficiency and emission compliance, it is turbo charged and features direct fuel injection, air-to-air after cooling and cooled EGR.

## Adjustable Eco-gauge and idle caution

The new Eco-gauge can be set to target a fuel consumption value, encouraging the operator to work as efficiently as possible. And to further avoid wasting fuel when the machine is not actually working, a standard-fit idle caution is displayed if the engine idles for 5 minutes or more.

### **Komatsu Diesel Particulate Filter (KDPF)**

Komatsu's high efficiency DPF captures more than 90% of particulate matter. It includes a special oxidation catalyst with fuel injection system that can incinerate trapped particulates by either active or passive regeneration with no need to interrupt machine operations.

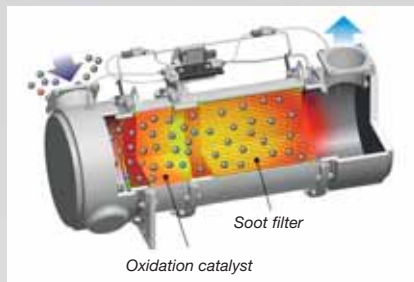

### **Exhaust Gas Recirculation (EGR)**

Cooled EGR is a technology well-proven in current Komatsu engines. The increased capacity of the EGR cooler now ensures very low NOx emissions and a better engine performance.

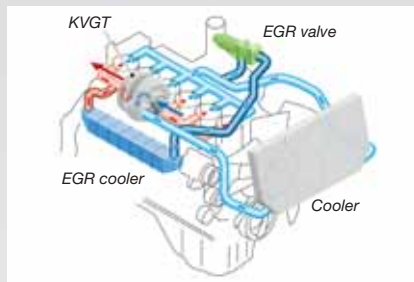

### **Komatsu Variable Geometry Turbo (KVG)**

The KVG provides optimal air flow to the engine combustion chamber under all speed and load conditions. Exhaust gas is cleaner, fuel economy is improved while machine power and performance are maintained.

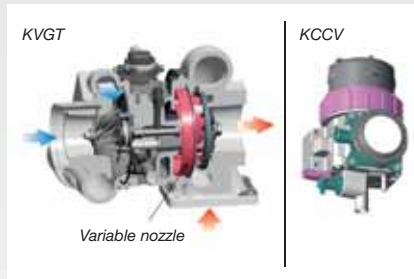

### **Komatsu Closed Crankcase Ventilation (KCCV)**

Crankcase emissions (blow-by gas) are passed through a CCV filter. The oil mist trapped in the filter is returned back to the crankcase while the filtered gas is returned to the air intake.

### **High-Pressure Common Rail (HPCR)**

To achieve complete fuel burn and lower exhaust emissions, the heavy duty High-Pressure Common Rail fuel injection system is computer controlled to deliver a precise quantity of pressurised fuel into the redesigned engine combustion chamber by multiple injections.

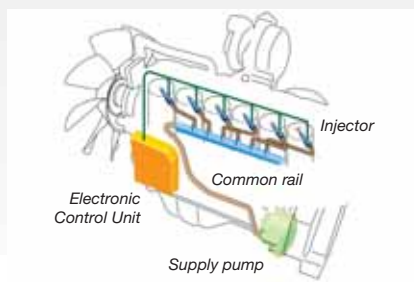

## High lift capacity

Along with its class leading compact size, the PW180-10 features an unrivalled lifting performance. The combination of power, convenient dimensions and complete control makes the PW180-10 the first choice for heavy duty lifting applications or simple excavating tasks in narrow alleys, road-construction sites and for sewer-construction work.





### **Excellent travel performance**

Wheeled excavators are built to move quickly on and between jobsites. To increase its mobility, the PW180-10 features a completely reworked driveline for faster travel and uphill driving speeds. For extra comfort, cruise control and a driveline-power-up function are also standard equipment.

### **Komatsu integrated hydraulic system**

The PW180-10 is a highly responsive and productive machine with all major hydraulic parts designed and manufactured by Komatsu.

The electronic Closed-centre Load Sensing hydraulic System (CLSS) offers complete control during individual or combined movements – without sacrificing performance or productivity.

# Easy Maintenance



## Electric refuelling pump

Standard equipment on all PW180-10 includes an automatic shut-off fuelling pump that allows easy refuelling from a barrel.

## Easy radiator access

Thanks to a side-by-side cooler arrangement, the aftercooler and hydraulic oil radiator can be cleaned easily and repaired individually in case of damage.

## Simple and convenient service

The large doors and engine hood give convenient access to all daily service points. Filters are centralized and required service intervals are longer to keep machine downtime to a minimum.



## Centralised greasing system

The PW180-10 features a centralised system that facilitates the regular greasing of the complete revolving frame, boom system and of the centre joint. An optional fully automatic greasing system can handle the regular and proper greasing of the complete machine – prolonging the lifetime and increasing the resale value of the excavator.



Komatsu CARE is a complimentary maintenance program for Komatsu customers that comes as standard with every new Komatsu EU Stage IIIB construction machine. For the first 3 years or 2.000 hours it covers factory-scheduled maintenance, performed by Komatsu-trained technicians with Komatsu Genuine parts. It also offers up to a maximum of 2 complimentary Komatsu Diesel Particulate Filter (KDPF) exchange units and a KDPF warranty for the first 5 years or 9.000 hours.







# Komatsu Wireless Monitoring System

## The easy way to higher productivity

KOMTRAX™ is the latest in wireless monitoring technology. It delivers insightful and cost saving information about your fleet and equipment and offers you a wealth of information to facilitate peak machine performance. By creating a tightly integrated web of support it allows pro active and preventive maintenance and helps you to efficiently run a business.

## Knowledge

You get quick answers to basic and critical questions about your machines – what they're doing, when they did it, where they're located, how they can be used more efficiently, and when they need to be serviced. Performance data is relayed by satellite from your machine to your computer and to your local Komatsu distributor – who's readily available for expert analysis and feedback.

## Convenience

KOMTRAX™ helps to conveniently manage your fleet on the web, wherever you are. Data is analysed and packaged specifically for easy and intuitive viewing in maps, lists, graphs and charts. You can anticipate the type of service and parts your machines could require, or troubleshoot problems before Komatsu technicians arrive on site.





## Power

The detailed information that KOMTRAX™ puts at your fingertips 24 hours a day, 7 days a week gives you the power to make better daily and long-term strategic decisions. You can anticipate problems, customize maintenance schedules, minimize downtime and keep your machines where they belong – working on the job site.



Through the web application, a variety of search parameters are available to quickly find information about specific machines based on key factors such as utilization rates, age, various notification messages, and more.

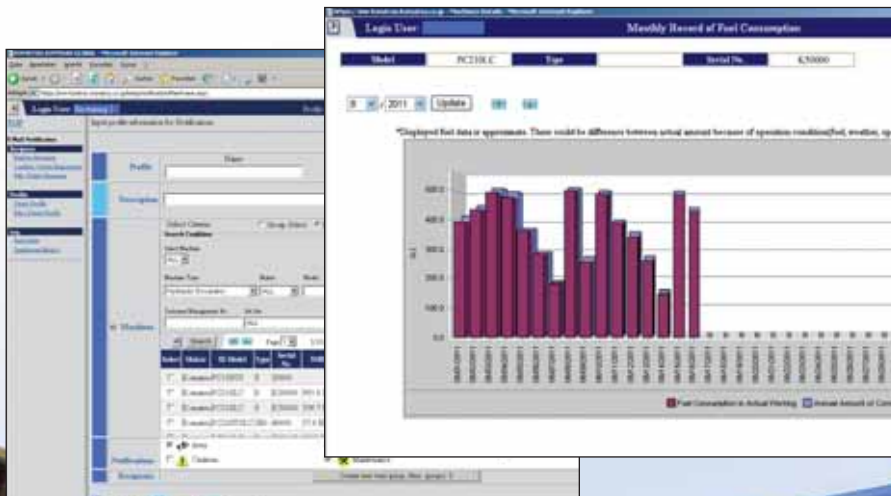

A simple chart shows the machine's fuel consumption and helps you to calculate total costs for a job site and conveniently schedule fuel deliveries.

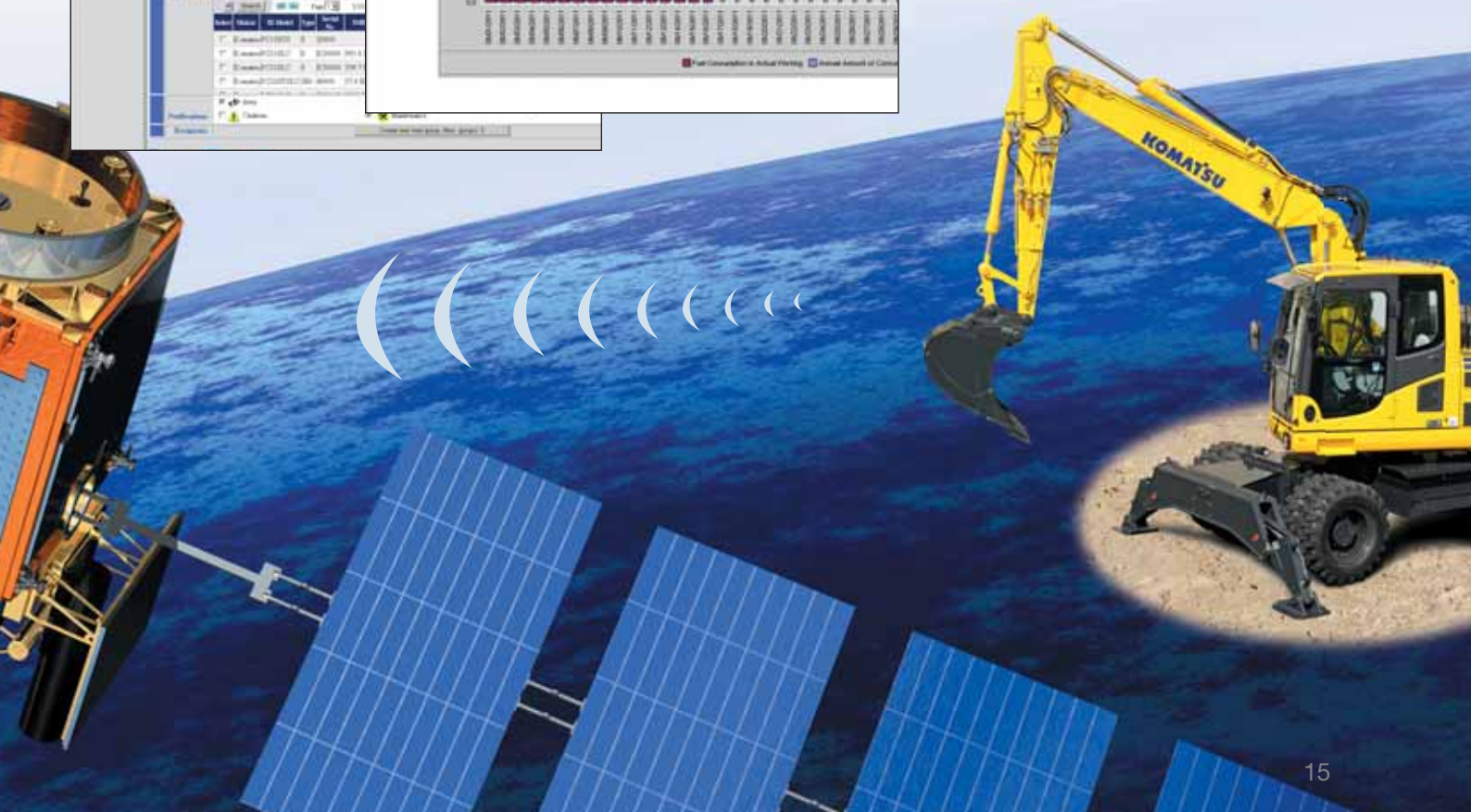

# Highest Safety Standards

## Optimal job site safety

Safety features on the Komatsu PW180-10 comply with the latest industry standards and work together as a system to minimise risks to personnel in and around the machine. An audible travel alarm further promotes job site safety. Very durable anti-slip plates – with additional high friction covering – maintain long term traction performance.

## Rear view camera

A standard fitment camera gives an exceptionally clear view of the rear work zone on the wide-screen monitor panel. The low profile camera is adjustable and integrated into the counterweight's shape. On request, another camera can be added to the right side of the machine.

## Safe SpaceCab™

Specifically designed for Komatsu excavators, the Dash 10 cab has a tubular steel frame. It provides very high shock absorbency, impact resistance and durability. The seat belt keeps the operator in the safety zone of the cab in the event of a roll-over. On request, the Komatsu PW180-10 can also be fitted with an ISO 10262 Level 2 Falling Object Protective System (FOPS).

## Safe and easy maintenance

Thermal guards are placed around high temperature parts of the engine. The fan belt and pulleys are well protected and in case of damage, fire risk is reduced by a pump/engine partition that prevents hydraulic oil from spraying onto the engine. The engine hood is hinged to the rear, with anti-slip plates positioned around the engine bay to ensure safe and easy access from all sides. Exceptionally sturdy handrails further contribute to a high safety level.

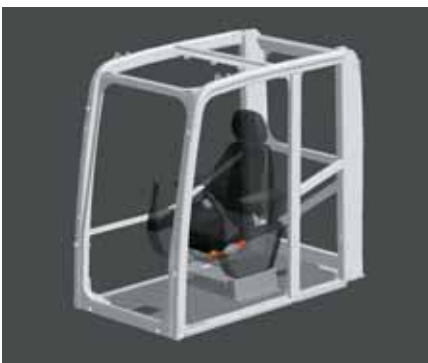





# Specifications

## ENGINE

Model .....	Komatsu SAA6D107E-2
Type.....	Common rail direct injection, water-cooled, emissionised, turbocharged, after-cooled diesel
Engine power	
at rated engine speed .....	2.000 rpm
ISO 14396 .....	123 kW / 165 HP
ISO 9249 (net engine power) .....	118 kW / 158 HP
No. of cylinders .....	6
Bore × stroke.....	107 × 124 mm
Displacement.....	6,69 ltr
Batteries .....	2 × 12 V/155 Ah
Alternator.....	24 V/60 A
Starter motor .....	24 V/5,5 kW
Air filter type .....	Double element type with monitor panel dust indicator and auto dust evacuator
Cooling .....	Suction type cooling fan with radiator fly screen

## HYDRAULIC SYSTEM

Type.....	HydrauMind. Closed-centre system with load sensing and pressure compensation valves
Additional circuits.....	Depending on the specification up to 2 additional proportional control & quick coupler circuits can be installed
Main pump .....	Variable displacement piston pump supplying boom, arm, bucket, swing and travel circuits
Maximum pump flow.....	288,4 ltr/min
Relief valve settings	
Implement .....	380 bar
Travel.....	420 bar
Swing.....	290 bar
Pilot circuit.....	36 bar

## BRAKE SYSTEM

Type.....	Dual circuit hydraulic braking system supplied from a separate gear pump
Service brakes.....	Pedal actuated wet multi-disc brakes integrated into the axle hubs
Parking brake .....	Electrically actuated wet multi-disc “spring actuation hydraulic release” brake integrated into the transmission

## ENVIRONMENT

Engine emissions .....	Fully complies with EU Stage IIIB and EPA Tier 4 interim exhaust emission regulations
Noise levels	
LwA external .....	101 dB(A) (2000/14/EC Stage II)
LpA operator ear.....	71 dB(A) (ISO 6396 dynamic test)
Vibration levels (EN 12096:1997)*	
Hand/arm.....	≤ 2,5 m/s <sup>2</sup> (uncertainty K = 0,495 m/s <sup>2</sup> )
Body .....	≤ 0,5 m/s <sup>2</sup> (uncertainty K = 0,16 m/s <sup>2</sup> )

\* for the purpose of risk assessment under directive 2002/44/EC, please refer to ISO/TR 25398:2006.

## SWING SYSTEM

Type.....	Axial piston motor driving through planetary double reduction gearbox
Swing lock .....	Electrically actuated wet multi-disc brake integrated into swing motor
Swing speed.....	0 - 11,5 rpm
Swing torque .....	43 kNm

## TRANSMISSION

Type.....	Fully automatic power shift transmission with permanent 4 wheel drive
Travel motors.....	One variable displacement axial piston motor
Maximum pressure.....	380 bar
Travel modes .....	Automatic + 3 travel modes
Max. travel speeds	
Hi / Lo / Creep .....	35,0 / 9,2 / 2,5 km/h
A max. speed restriction of 20 km/h is available as an option.	
Maximum drawbar pull.....	10.900 kg
Axle oscillation.....	10° Lockable in any position from the operator cab.

## STEERING SYSTEM

Steering control .....	Hydraulic steering system supplied from a separate gear pump and controlled through LS orbitrol & priority valves
Minimum turning radius.....	6.800 mm (to center of outer wheel)

## SERVICE REFILL CAPACITIES

Fuel tank.....	328 ltr
Radiator .....	12,62 ltr
Engine oil.....	23,1 ltr
Swing drive.....	5,5 ltr
Hydraulic tank .....	167 ltr
Transmission.....	4,85 ltr
Front differential .....	11,5 ltr
Rear differential .....	9,5 ltr
Front axle hub .....	2,85 ltr
Rear axle hub .....	2,0 ltr
Swing pinion grease bath amount.....	10,5 ltr



## OPERATING WEIGHT (APPR.)

Undercarriage attachment type	Mono boom	Two-piece boom
Without	16.680 kg	16.875 kg
Rear blade	17.510 kg	17.705 kg
Rear outrigger	17.710 kg	17.905 kg
2 outriggers + blade	18.540 kg	18.730 kg
4 outriggers	18.740 kg	18.930 kg

Operating weight, including specified work equipment, 2.600 mm arm, 2.550 mm undercarriage, operator, lubricant, coolant, full fuel tank and the standard equipment.  
Weights are without bucket.

## MAX. BUCKET CAPACITY AND WEIGHT

Arm length	Mono boom		
	2,25 m	2,6 m	2,9 m
Material weight up to 1,2 t/m <sup>3</sup>	1,13 m <sup>3</sup> 675 kg	1,04 m <sup>3</sup> 645 kg	0,94 m <sup>3</sup> 615 kg
Material weight up to 1,5 t/m <sup>3</sup>	0,94 m <sup>3</sup> 615 kg	0,85 m <sup>3</sup> 585 kg	0,75 m <sup>3</sup> 525 kg
Material weight up to 1,8 t/m <sup>3</sup>	0,85 m <sup>3</sup> 585 kg	0,75 m <sup>3</sup> 525 kg	0,66 m <sup>3</sup> 495 kg
Arm length	Two-piece boom		
	2,25 m	2,6 m	2,9 m
Material weight up to 1,2 t/m <sup>3</sup>	1,13 m <sup>3</sup> 675 kg	1,04 m <sup>3</sup> 645 kg	0,94 m <sup>3</sup> 615 kg
Material weight up to 1,5 t/m <sup>3</sup>	0,94 m <sup>3</sup> 615 kg	0,85 m <sup>3</sup> 585 kg	0,75 m <sup>3</sup> 525 kg
Material weight up to 1,8 t/m <sup>3</sup>	0,85 m <sup>3</sup> 585 kg	0,75 m <sup>3</sup> 525 kg	0,66 m <sup>3</sup> 495 kg

Max. capacity and weight have been calculated according to ISO 10567:2007.

Please consult with your distributor for the correct selection of buckets and attachments to suit the application.

## BUCKET AND ARM FORCE

Arm length	2,25 m	2,6 m	2,9 m
Bucket digging force	10.200 kg (115 kN)	10.200 kg (115 kN)	10.200 kg (115 kN)
Bucket digging force at PowerMax	12.500 kg (123 kN)	12.500 kg (123 kN)	12.500 kg (123 kN)
Arm crowd force	9.100 kg (89 kN)	8.200 kg (80 kN)	7.600 kg (74 kN)
Arm crowd force at PowerMax	9.700 kg (95 kN)	9.000 kg (88 kN)	8.100 kg (79 kN)

# Dimensions

## MONO BOOM

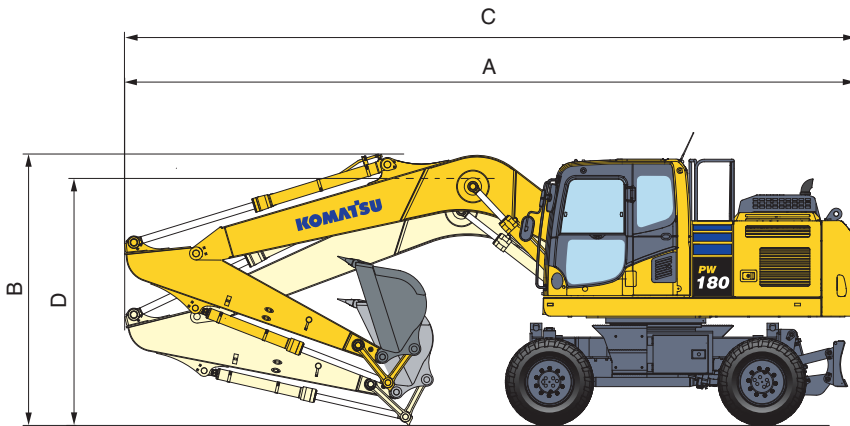

### Driving position

Arm length	A	B
2,25 m	8.935 mm	3.450 mm
2,6 m	8.935 mm	3.450 mm
2,9 m *	8.935 mm	3.450 mm

### Transport position

Arm length	C	D
2,25 m	8.970 mm	3.025 mm
2,6 m	8.970 mm	3.040 mm
2,9 m	8.985 mm	3.130 mm

\* Driving position without bucket

## TWO-PIECE BOOM

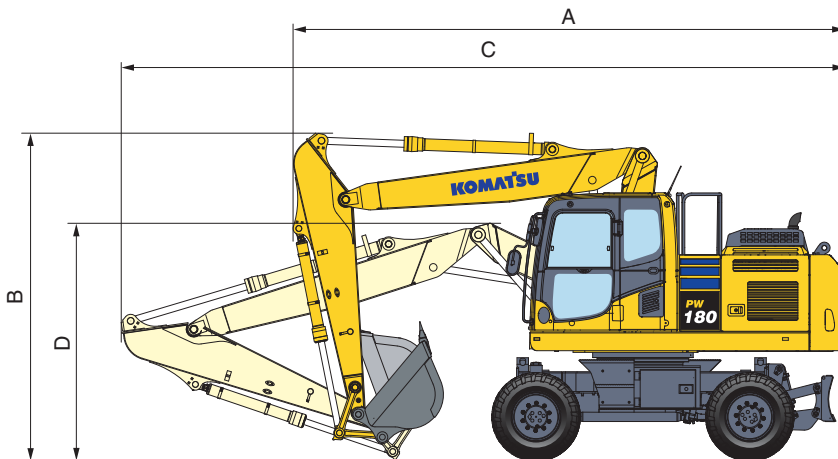

### Driving position

Arm length	A	B
2,25 m	6.750 mm	3.925 mm
2,6 m	6.675 mm	3.925 mm
2,9 m *	6.720 mm	3.925 mm

### Transport position

Arm length	C	D
2,25 m	8.910 mm	2.775 mm
2,6 m	8.905 mm	2.855 mm
2,9 m	8.880 mm	3.030 mm

\* Driving position without bucket



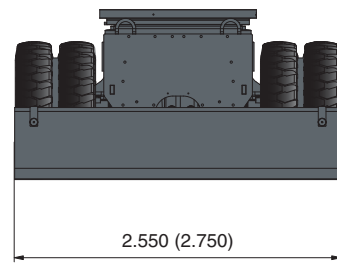
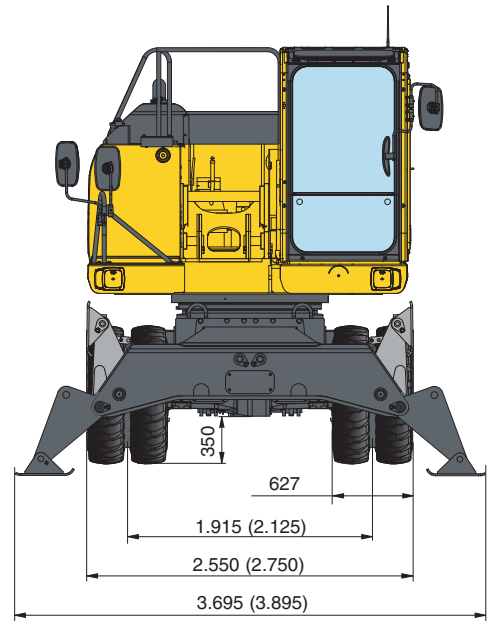
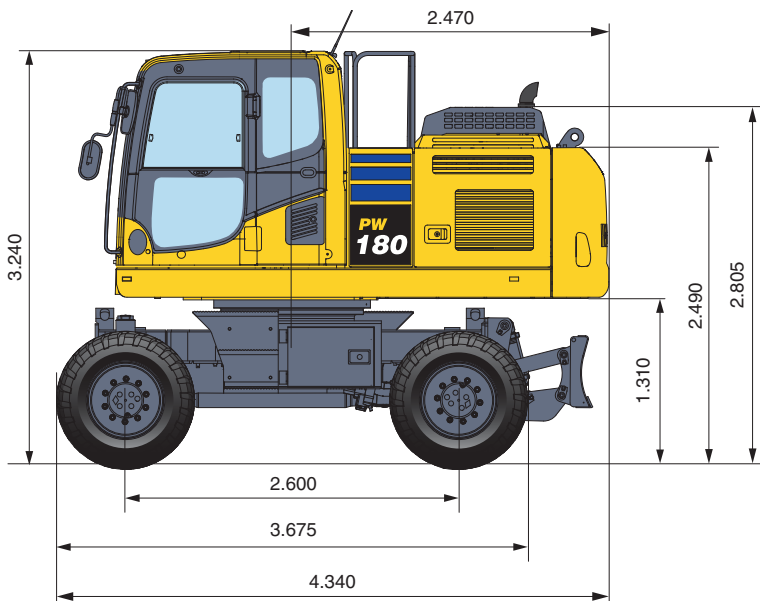

( ): Figures for 2,75 m undercarriage

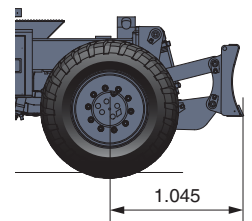
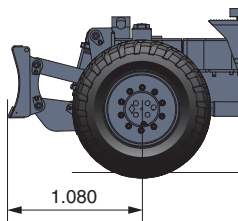
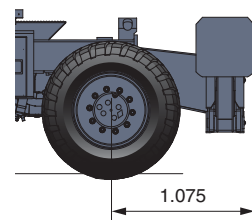
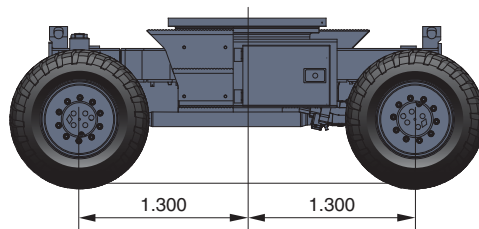
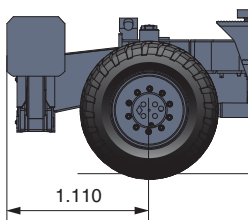

# Working Range

## MONO BOOM

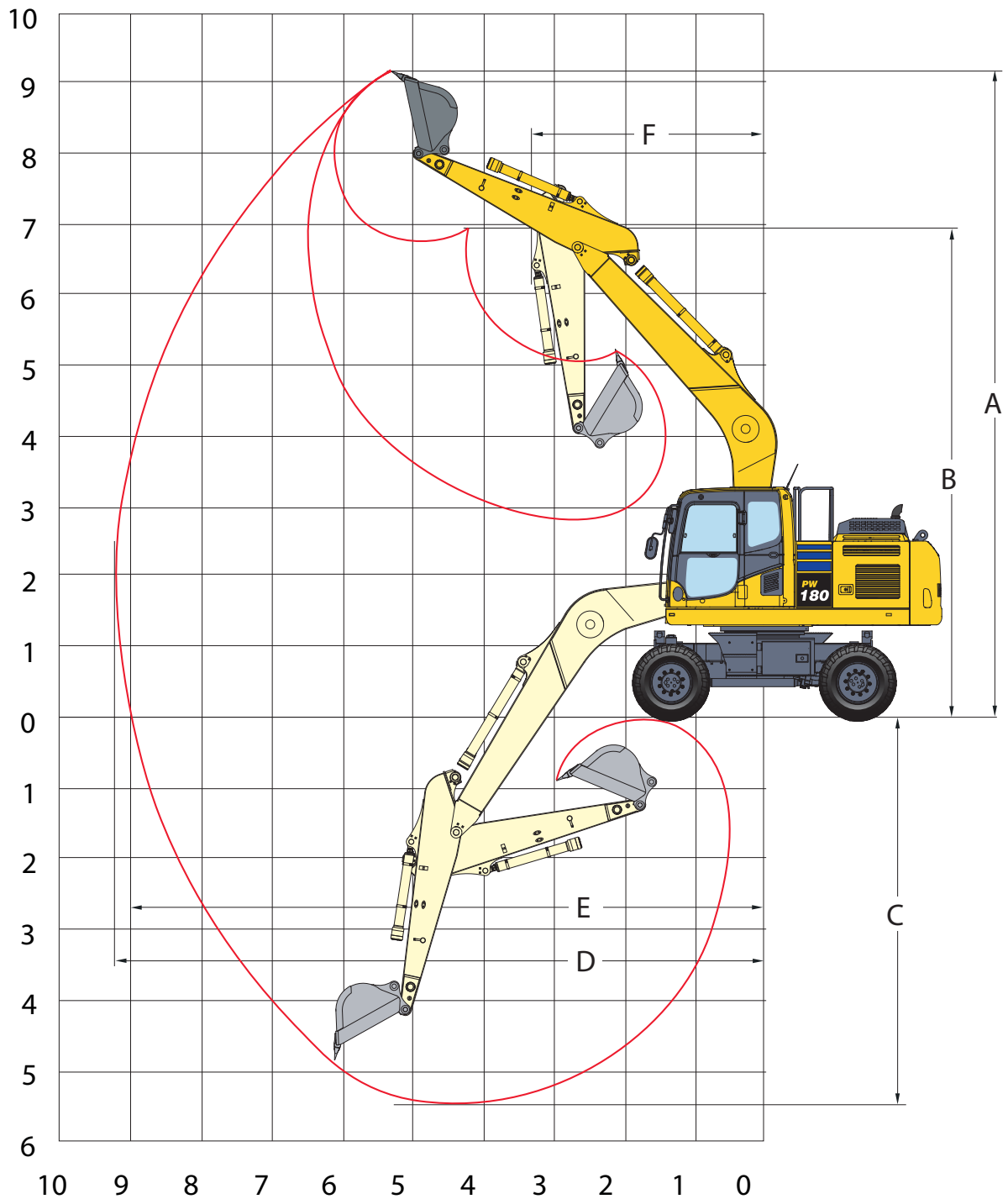

ARM LENGTH	2,25 m	2,6 m	2,9 m
A Max. digging height	9.458 mm	9.562 mm	9.756 mm
B Max. dumping height	6.915 mm	7.064 mm	7.236 mm
C Max. digging depth	5.321 mm	5.676 mm	5.966 mm
D Max. digging reach	9.061 mm	9.345 mm	9.929 mm
E Max. digging reach at ground level	8.876 mm	9.170 mm	9.759 mm
F Min. swing radius	3.543 mm	3.829 mm	4.057 mm





## TWO-PIECE BOOM

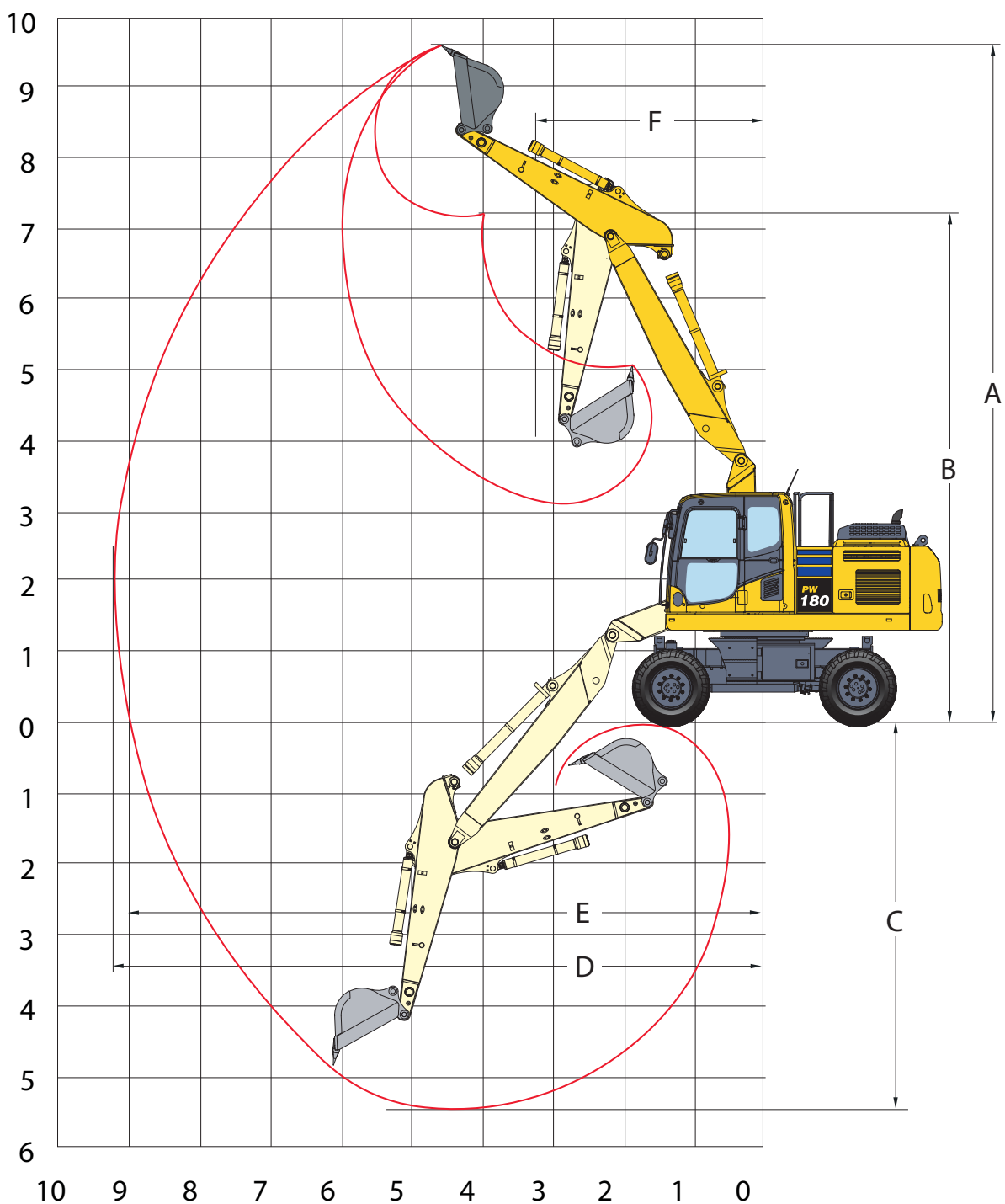

ARM LENGTH	2,25 m	2,6 m	2,9 m
A Max. digging height	9.942 mm	10.129 mm	10.350 mm
B Max. dumping height	7.283 mm	7.489 mm	7.709 mm
C Max. digging depth	5.400 mm	5.742 mm	6.044 mm
D Max. digging reach	9.080 mm	9.401 mm	9.683 mm
E Max. digging reach at ground level	8.907 mm	9.227 mm	9.509 mm
F Min. swing radius	3.065 mm	3.311 mm	3.511 mm

# Lifting Capacity

## Mono boom / undercarriage width 2,55 m

Arm length	A B	⊗		7,5 m		6,0 m		4,5 m		3,0 m		1,5 m		
		⊗	⊗	⊗	⊗	⊗	⊗	⊗	⊗	⊗	⊗	⊗	⊗	
 <p>Without stabilizer</p>	2,25 m	7,5 m kg	*3.350	*3.350					*5.150	4.800				
		6,0 m kg	*3.000	2.450			4.100	3.000		*5.600	4.800			
		4,5 m kg	2.800	2.000	2.800	2.000	4.000	2.900		6.300	4.500	*8.150	*8.150	
		3,0 m kg	2.500	1.800	2.700	1.950	3.800	2.750		5.850	4.150			
		1,5 m kg	2.400	1.700	2.650	1.900	3.650	2.550		5.450	3.800			
		0,0 m kg	2.400	1.750	2.550	1.800	3.450	2.450		5.250	3.600			
		- 1,5 m kg	2.650	1.900			3.400	2.400		5.200	3.550	*9.100	6.400	
		- 3,0 m kg	3.200	2.350			3.450	2.450		5.250	3.600	*8.500	6.550	
		- 4,5 m kg												
	2,6 m	7,5 m kg	*2.750	*2.750										
		6,0 m kg	*2.550	2.250			4.150	3.050						
		4,5 m kg	*2.450	1.850	2.800	2.000	4.050	2.950		*6.050	4.600			
		3,0 m kg	2.350	1.650	2.700	1.950	3.850	2.750		5.900	4.200			
		1,5 m kg	2.250	1.600	2.600	1.850	3.600	2.550		5.450	3.800			
		0,0 m kg	2.250	1.600	2.550	1.800	3.450	2.400		5.200	3.550	*5.600	*5.600	
		- 1,5 m kg	2.450	1.750	2.550	1.750	3.400	2.400		5.100	3.450	*8.950	6.300	
		- 3,0 m kg	2.900	2.100			3.350	2.400		5.150	3.500	*9.450	6.400	
		- 4,5 m kg												
	2,9 m	7,5 m kg	*2.350	*2.350			*3.000	*3.000						
		6,0 m kg	*2.150	2.050			4.100	3.000						
		4,5 m kg	*2.100	1.700	2.750	1.950	4.000	2.900		*5.050	4.600			
		3,0 m kg	*2.150	1.500	2.650	1.900	3.800	2.700		5.950	4.200	11.600	7.700	
		1,5 m kg	2.100	1.450	2.550	1.800	3.600	2.550		5.500	3.800			
		0,0 m kg	2.100	1.500	2.450	1.700	3.400	2.400		5.200	3.550	*5.750	*5.750	
		- 1,5 m kg	2.250	1.600	2.400	1.650	3.350	2.300		5.100	3.450	*8.500	6.200	*5.100
		- 3,0 m kg	2.700	1.900			3.350	2.300		5.100	3.450	10.050	6.300	
		- 4,5 m kg	*4.150	3.000						*4.800	3.600			
 <p>Front or rear blade</p>	2,25 m	7,5 m kg	*3.350	*3.350					*5.150	*5.200				
		6,0 m kg	*3.000	2.850			4.500	3.450		*5.600	5.450			
		4,5 m kg	*2.900	2.350	*2.900	2.350	4.450	3.350		6.900	5.200	*8.150	*8.150	
		3,0 m kg	2.800	2.100	3.050	2.250	4.050	3.150		6.450	4.800			
		1,5 m kg	2.700	2.000	3.000	2.200	4.050	3.000		6.100	4.400			
		0,0 m kg	2.750	2.050	2.900	2.150	3.900	2.850		5.850	4.200			
		- 1,5 m kg	3.000	2.250			3.900	2.850		5.800	4.200	*9.100	7.650	
		- 3,0 m kg	3.700	2.700			3.900	2.850		5.850	4.200	*8.500	7.800	
		- 4,5 m kg												
	2,6 m	7,5 m kg	*2.750	*2.750										
		6,0 m kg	*2.550	*2.550			*4.500	3.450						
		4,5 m kg	*2.450	2.150	3.100	2.350	4.450	3.350		*6.050	5.250			
		3,0 m kg	*2.550	1.950	2.950	2.250	4.250	3.150		6.550	4.800			
		1,5 m kg	2.550	1.850	2.950	2.150	4.050	3.000		6.100	4.400			
		0,0 m kg	2.550	1.900	2.850	2.100	3.900	2.850		5.850	4.200	*5.600	*5.600	
		- 1,5 m kg	2.800	2.050	2.850	2.100	3.800	2.800		5.750	4.100	*8.950	7.500	
		- 3,0 m kg	3.350	2.450			3.850	2.800		5.800	4.150	*9.450	7.650	
		- 4,5 m kg												
	2,9 m	7,5 m kg	*2.350	*2.350			*3.000	*3.000						
		6,0 m kg	*2.150	*2.200			*4.100	3.450						
		4,5 m kg	*2.100	2.000	2.950	2.300	4.400	3.300		*5.050	*5.050			
		3,0 m kg	*2.150	1.800	3.000	2.250	4.200	3.150		6.550	4.850	*12.050	9.000	
		1,5 m kg	*2.300	1.700	2.900	2.100	3.800	2.950		6.100	4.450			
		0,0 m kg	2.400	1.750	2.700	2.050	3.850	2.800		5.800	4.150	*5.750	*5.750	
		- 1,5 m kg	2.600	1.900	2.750	2.000	3.750	2.700		5.700	4.050	*8.500	7.400	*5.100
		- 3,0 m kg	3.050	2.250			3.550	2.700		5.700	4.050	*10.250	7.550	*5.100
		- 4,5 m kg	*4.150	3.550						*4.800	4.200			
 <p>Rear outrigger</p>	2,25 m	7,5 m kg	*3.350	*3.350					*5.150	*5.150				
		6,0 m kg	*3.000	*3.000			4.650	4.150		*5.600	*5.600			
		4,5 m kg	*2.900	2.850	*2.900	2.850	4.550	4.050		7.100	6.300	*8.150	*8.150	
		3,0 m kg	2.900	2.550	3.150	2.800	4.350	3.900		6.650	5.850			
		1,5 m kg	2.800	2.450	3.050	2.700	4.200	3.700		6.300	5.450			
		0,0 m kg	2.850	2.500	3.000	2.650	4.050	3.550		6.050	5.250			
		- 1,5 m kg	3.150	2.750			4.000	3.500		6.000	5.200	*9.100	*9.100	
		- 3,0 m kg	3.800	3.350			4.050	3.550		6.050	5.250	*8.500	*8.500	
		- 4,5 m kg												
	2,6 m	7,5 m kg	*2.750	*2.750										
		6,0 m kg	*2.550	*2.550			*4.500	4.200						
		4,5 m kg	*2.450	*2.500	3.050	2.850	4.550	4.050		*6.050	*6.000			
		3,0 m kg	*2.550	2.400	3.150	2.750	4.350	3.900		6.750	5.900			
		1,5 m kg	2.650	2.300	3.000	2.700	4.200	3.650		6.300	5.500			
		0,0 m kg	2.700	2.350	2.950	2.600	4.050	3.500		6.000	5.250	*5.600	*5.600	
		- 1,5 m kg	2.900	2.550	2.950	2.550	3.950	3.450		5.900	5.100	*8.950	*8.950	
		- 3,0 m kg	3.450	3.000			3.950	3.450		5.950	5.150	*9.450	*9.450	
		- 4,5 m kg												
	2,9 m	7,5 m kg	*2.350	*2.350			*3.000	*3.000						
		6,0 m kg	*2.150	*2.150			*4.100	*4.100						
		4,5 m kg	*2.100	*2.100	3.100	2.800	4.350	4.050		*5.050	*5.050			
		3,0 m kg	*2.150	*2.150	3.100	2.700	4.350	3.850		6.750	5.950	*12.050	11.300	
		1,5 m kg	*2.300	2.150	3.000	2.600	4.150	3.600		6.300	5.500			
		0,0 m kg	2.500	2.150	2.900	2.550	4.000	3.450		6.000	5.200	*5.750	*5.750	
		- 1,5 m kg	2.700	2.350	2.850	2.500	3.900	3.400		5.850	5.100	*8.500	*8.500	*5.100
		- 3,0 m kg	3.150	2.750			3.900	3.400		5.850	5.100	*10.250	9.750	*5.100
		- 4,5 m kg	*4.150	*4.150						*4.800	*4.800			





Arm length	A	⊗		7,5 m		6,0 m		4,5 m		3,0 m		1,5 m	
		⊗	⊗	⊗	⊗	⊗	⊗	⊗	⊗	⊗	⊗	⊗	⊗
 <p>Outrigger + blade</p>	2,25 m	7,5 m	kg	*3.350	*3.350					*5.150	*5.150		
		6,0 m	kg	*3.000	*3.000			*5.000	*5.000	*5.600	*5.600		
		4,5 m	kg	*2.900	*2.900	*2.900	*2.900	*6.050	5.050	*7.250	*7.250	*8.150	*8.150
		3,0 m	kg	*2.950	*2.950	*5.000	3.450	*6.550	4.850	*8.600	7.500		
		1,5 m	kg	*3.100	3.100	*5.500	3.400	*6.950	4.650	*9.550	7.050		
		0,0 m	kg	*3.450	3.150	*5.300	3.300	*7.000	4.500	*9.450	6.850		
		- 1,5 m	kg	*4.150	3.450			*6.400	4.500	*8.600	6.800	*9.100	*9.100
		- 3,0 m	kg	*4.150	*4.150			*4.700	4.500	*6.700	*6.700	*8.500	*8.500
		- 4,5 m	kg										
	2,6 m	7,5 m	kg	*2.750	*2.750								
		6,0 m	kg	*2.550	*2.550			*4.500	*4.500				
		4,5 m	kg	*2.450	*2.450	*3.600	3.550	*5.550	5.050	*6.050	*6.050		
		3,0 m	kg	*2.550	*2.550	*4.950	3.450	*6.350	4.850	*8.250	7.550		
		1,5 m	kg	*2.700	*2.700	*5.450	3.350	*6.800	4.650	*9.300	7.100		
		0,0 m	kg	*3.050	3.000	*5.350	3.300	*6.950	4.500	*9.550	6.800	*5.600	*5.600
		- 1,5 m	kg	*3.600	3.250	*4.150	3.300	*6.500	4.400	*8.750	6.750	*8.950	*8.950
		- 3,0 m	kg	*4.250	3.900			*5.200	4.450	*7.150	6.750	*9.450	*9.450
		- 4,5 m	kg										
	2,9 m	7,5 m	kg	*2.350	*2.350			*3.000	*3.000				
		6,0 m	kg	*2.150	*2.150			*4.100	*4.100				
		4,5 m	kg	*2.100	*2.100	*3.700	3.500	*4.900	*4.900	*5.050	*5.050		
		3,0 m	kg	*2.150	*2.150	*4.700	3.450	*6.100	4.850	*7.800	7.650	*12.050	*12.050
		1,5 m	kg	*2.300	*2.300	*5.350	3.300	*6.650	4.650	*9.100	7.100		
		0,0 m	kg	*2.600	*2.600	*5.350	3.250	*6.850	4.450	*9.450	6.800	*5.750	*5.750
		- 1,5 m	kg	*3.050	3.000	*4.850	3.200	*6.550	4.350	*8.950	6.650	*8.500	*8.500
		- 3,0 m	kg	*4.050	3.550			*5.500	4.350	*7.550	6.700	*10.250	*10.250
		- 4,5 m	kg	*4.150	*4.150					*4.800	*4.800		

 <p>Outrigger front + rear</p>	2,25 m	7,5 m	kg	*3.350	*3.350					*5.150	*5.150		
		6,0 m	kg	*3.000	*3.000			*5.000	*5.000	*5.600	*5.600		
		4,5 m	kg	*2.900	*2.900	*2.900	*2.900	*6.050	*6.050	*7.250	*7.250	*8.150	*8.150
		3,0 m	kg	*2.950	*2.950	*5.000	3.950	*6.550	6.000	*8.600	*8.600		
		1,5 m	kg	*3.100	*3.100	*5.500	4.150	*6.950	5.750	*9.550	9.000		
		0,0 m	kg	*3.450	*3.450	*5.300	3.800	*7.000	5.600	*9.450	8.750		
		- 1,5 m	kg	*4.150	*4.150			*6.400	5.550	*8.600	*8.600	*9.100	*9.100
		- 3,0 m	kg	*4.150	*4.150			*4.700	*4.700	*6.700	*6.700	*8.500	*8.500
		- 4,5 m	kg										
	2,6 m	7,5 m	kg	*2.750	*2.750								
		6,0 m	kg	*2.550	*2.550			*4.500	*4.500				
		4,5 m	kg	*2.450	*2.450	*3.600	*3.600	*5.550	*5.550	*6.050	*6.050		
		3,0 m	kg	*2.550	*2.550	*4.950	4.200	*6.350	6.000	*8.250	*8.250		
		1,5 m	kg	*2.700	*2.700	*5.450	3.850	*6.800	5.750	*9.300	9.000		
		0,0 m	kg	*3.050	*3.050	*5.350	4.050	*6.950	5.550	*9.550	8.700	*5.600	*5.600
		- 1,5 m	kg	*3.600	*3.600	*4.150	4.050	*6.500	5.500	*8.750	8.600	*8.950	*8.950
		- 3,0 m	kg	*4.250	*4.250			*5.200	*5.200	*7.150	*7.150	*9.450	*9.450
		- 4,5 m	kg										
	2,9 m	7,5 m	kg	*2.350	*2.350			*3.000	*3.000				
		6,0 m	kg	*2.150	*2.150			*4.100	*4.100				
		4,5 m	kg	*2.100	*2.100	*3.700	*3.700	*4.900	*4.900	*5.050	*5.050		
		3,0 m	kg	*2.150	*2.150	*4.700	4.200	*6.100	5.950	*7.800	*7.800	*12.050	*12.050
		1,5 m	kg	*2.300	*2.300	*5.350	4.050	*6.650	5.700	*9.100	9.050		
		0,0 m	kg	*2.600	*2.600	*5.350	4.000	*6.850	5.550	*9.450	8.700	*5.750	*5.750
		- 1,5 m	kg	*3.050	*3.050	*4.850	3.950	*6.550	5.450	*8.950	8.550	*8.500	*8.500
		- 3,0 m	kg	*4.050	*4.050			*5.500	5.450	*7.550	*7.550	*10.250	*10.250
		- 4,5 m	kg	*4.150	*4.150					*4.800	*4.800		

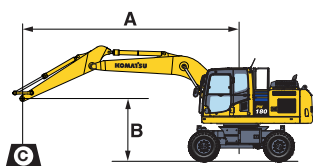

- A – Reach from swing center
- B – Bucket hook height
- C – Lifting capacities, including bucket linkage (120 kg) and bucket cylinder (109 kg)

When removing linkage or cylinder, lifting capacities can be increased by their respective weights.

\* Load is limited by hydraulic capacity rather than tipping. Ratings are based on SAE Standard No. J1097. Rated loads do not exceed 87% of hydraulic lift capacity or 75% of tipping load.

-  – Rating over front
-  – Rating over side
-  – Rating at maximum reach

# Lifting Capacity

## Two-piece boom / undercarriage width 2,55 m

Arm length	A	7,5 m		6,0 m		4,5 m		3,0 m		1,5 m		
 Without stabilizer	2,25 m	7,5 m kg	*3.650	3.400				*5.450	4.800			
		6,0 m kg	*3.150	2.400			4.100	3.000	*5.400	4.800		
		4,5 m kg	2.750	2.000	2.800	2.050	4.050	2.950	6.300	4.550	*6.350	*6.350
		3,0 m kg	2.550	1.800	2.750	1.950	3.850	2.800	5.900	4.200		
		1,5 m kg	2.400	1.750	2.700	1.950	3.700	2.600	5.550	3.800		
		0,0 m kg	2.450	1.800	2.650	1.850	3.600	2.550	5.350	3.650		
	- 1,5 m kg	2.650	1.950			3.450	2.450	5.300	3.600	*8.250	6.600	
	- 3,0 m kg											
	- 4,5 m kg											
	2,6 m	7,5 m kg	*3.000	*3.000								
		6,0 m kg	*2.700	2.200			4.150	3.000				
		4,5 m kg	*2.550	1.850	2.800	2.050	4.050	2.950	*5.400	4.600		
		3,0 m kg	2.350	1.650	2.700	1.950	3.850	2.800	5.950	4.200		
		1,5 m kg	2.200	1.600	2.650	1.900	3.650	2.550	5.550	3.850		
		0,0 m kg	2.300	1.650	2.600	1.800	3.500	2.450	5.300	3.600		
- 1,5 m kg	2.500	1.800	2.550	1.800	3.450	2.400	5.250	3.550	*8.150	6.450		
- 3,0 m kg	3.250	2.250			3.500	2.450	5.250	3.600				
- 4,5 m kg												
2,9 m	7,5 m kg	*2.550	*2.550			*3.450	3.000					
	6,0 m kg	*2.300	2.000			4.100	3.000					
	4,5 m kg	*2.200	1.650	2.750	1.950	4.000	2.900	*4.550	*4.550			
	3,0 m kg	2.150	1.500	2.700	1.950	3.800	2.750	6.000	4.200			
	1,5 m kg	2.100	1.450	2.600	1.800	3.600	2.550	5.550	3.850			
	0,0 m kg	2.150	1.500	2.450	1.750	3.450	2.400	5.250	3.600	*4.900	*4.900	
- 1,5 m kg	2.300	1.650	2.500	1.750	3.400	2.350	5.150	3.500	*7.700	6.350		
- 3,0 m kg	2.800	1.950			3.450	2.350	5.200	3.550				
- 4,5 m kg												
 Front or rear blade	2,25 m	7,5 m kg	*3.650	*3.650				*5.450	5.450			
		6,0 m kg	*3.150	2.800			4.500	3.450	*5.400	*5.350		
		4,5 m kg	2.950	2.300	3.150	2.350	4.450	3.350	*6.500	5.200	*6.350	*6.350
		3,0 m kg	2.850	2.100	2.900	2.300	4.300	3.200	6.500	4.800		
		1,5 m kg	2.700	2.000	3.000	2.250	4.100	3.050	6.150	4.500		
		0,0 m kg	2.800	2.100	2.800	2.200	4.000	2.950	6.000	4.300		
	- 1,5 m kg	3.100	2.250			3.950	2.900	5.950	4.250	*8.250	7.850	
	- 3,0 m kg											
	- 4,5 m kg											
	2,6 m	7,5 m kg	*3.000	*3.000								
		6,0 m kg	*2.700	2.550			4.550	3.450				
		4,5 m kg	*2.550	2.150	3.150	2.350	4.450	3.350	*5.400	5.250		
		3,0 m kg	*2.550	1.950	3.050	2.250	4.250	3.200	6.600	4.850		
		1,5 m kg	2.550	1.900	3.000	2.200	4.100	3.000	6.150	4.500		
		0,0 m kg	2.600	1.950	2.900	2.150	3.950	2.900	5.900	4.250		
- 1,5 m kg	2.850	2.100	2.900	2.100	3.900	2.850	5.850	4.200	*8.150	7.700		
- 3,0 m kg	3.600	2.700			3.950	2.850	5.900	4.200				
- 4,5 m kg												
2,9 m	7,5 m kg	*2.550	*2.550			*3.450	3.450					
	6,0 m kg	*2.300	*2.300			*4.150	3.450					
	4,5 m kg	*2.200	1.950	3.000	2.300	4.450	3.300	*4.550	*4.550			
	3,0 m kg	*2.200	1.800	3.000	2.250	4.250	3.150	6.600	4.850			
	1,5 m kg	*2.300	1.750	2.900	2.150	4.050	3.000	6.150	4.500			
	0,0 m kg	2.400	1.750	2.850	2.100	3.900	2.850	5.900	4.200	*4.900	*4.900	
- 1,5 m kg	2.650	1.900	2.850	2.050	3.850	2.800	5.800	4.150	*7.700	7.650		
- 3,0 m kg		2.300			3.850	2.800		4.150				
- 4,5 m kg												
 Rear outrigger	2,25 m	7,5 m kg	*3.650	*3.600				*5.450	*5.450			
		6,0 m kg	*3.150	*3.150			4.650	4.150	*5.400	*5.350		
		4,5 m kg	*3.000	2.850	3.200	2.850	4.550	4.050	*6.500	6.300	*6.350	*6.350
		3,0 m kg	2.900	2.550	3.050	2.800	4.400	3.900	6.700	5.900		
		1,5 m kg	2.850	2.500	3.100	2.700	4.200	3.750	6.300	5.550		
		0,0 m kg	2.900	2.550	3.050	2.700	4.100	3.600	6.150	5.350		
	- 1,5 m kg	3.150	2.800			4.050	3.600	6.100	5.300	*8.250	*8.250	
	- 3,0 m kg											
	- 4,5 m kg											
	2,6 m	7,5 m kg	*3.000	*3.000								
		6,0 m kg	*2.700	*2.650			*4.650	4.150				
		4,5 m kg	*2.550	*2.550	3.200	2.850	4.600	4.050	*5.400	*5.400		
		3,0 m kg	*2.550	2.400	3.150	2.800	4.400	3.900	6.750	5.950		
		1,5 m kg	*2.650	2.300	3.050	2.700	4.200	3.700	6.350	5.550		
		0,0 m kg	2.700	2.400	3.000	2.650	4.050	3.600	6.100	5.300		
- 1,5 m kg	2.950	2.550	3.000	2.650	4.050	3.500	6.000	5.250	*8.150	*8.150		
- 3,0 m kg	3.750	3.300			4.050	3.550	6.100	5.300				
- 4,5 m kg												
2,9 m	7,5 m kg	*2.550	*2.550			*3.450	*3.450					
	6,0 m kg	*2.300	*2.300			*4.150	4.150					
	4,5 m kg	*2.200	*2.200	3.100	2.850	4.550	4.050	*4.550	*4.550			
	3,0 m kg	*2.200	*2.200	3.100	2.750	4.350	3.850	6.750	5.950			
	1,5 m kg	*2.300	2.150	3.000	2.650	4.200	3.650	6.350	5.550			
	0,0 m kg	2.350	2.200	2.950	2.550	4.050	3.550	6.100	5.250	*4.900	*4.900	
- 1,5 m kg	2.700	2.400	2.900	2.550	3.950	3.450	6.000	5.200	*7.700	*7.700		
- 3,0 m kg	3.300	2.850			4.000	3.450	6.000	5.250				
- 4,5 m kg												





Arm length	A	⊗		7,5 m		6,0 m		4,5 m		3,0 m		1,5 m		
		⊗	⊗	⊗	⊗	⊗	⊗	⊗	⊗	⊗	⊗	⊗	⊗	
 <p>Outrigger + blade</p>	2,25 m	7,5 m kg	*3.650	*3.650					*5.450	*5.450				
		6,0 m kg	*3.150	*3.150			*5.200	5.150	*5.400	*5.400				
		4,5 m kg	*3.000	*3.000	*3.350	*3.350	*5.600	5.050	*6.500	*6.500	*6.350	*6.350		
		3,0 m kg	*3.000	*3.000	*4.750	3.500	*5.950	4.900	*8.250	7.550				
		1,5 m kg	*3.050	*3.050	*4.950	3.450	*6.400	4.700	*9.550	7.150				
		0,0 m kg	*3.350	3.200	*5.200	3.400	*7.000	4.600	*9.550	6.950				
	- 1,5 m kg	*3.850	3.550			*6.400	4.550	*8.700	6.900	*8.250	*8.250			
	- 3,0 m kg													
	- 4,5 m kg													
	2,6 m	7,5 m kg	*3.000	*3.000										
		6,0 m kg	*2.700	*2.700			*4.650	*4.650						
		4,5 m kg	*2.550	*2.550	*3.950	3.600	*5.400	5.100	*5.400	*5.400				
3,0 m kg		*2.550	*2.550	*4.600	3.500	*5.700	4.900	*7.800	7.650					
1,5 m kg		*2.650	*2.650	*4.800	3.400	*6.200	4.700	*9.300	7.200					
0,0 m kg		*2.900	*2.900	*5.050	3.350	*6.750	4.550	*9.550	6.900					
- 1,5 m kg	*3.350	3.300	*4.600	3.300	*6.600	4.500	*8.950	6.850	*8.150	*8.150				
- 3,0 m kg	*4.700	4.200			*5.250	4.550	*7.300	6.900						
- 4,5 m kg														
2,9 m	7,5 m kg	*2.550	*2.550			*3.450	*3.450							
	6,0 m kg	*2.300	*2.300			*4.150	*4.150							
	4,5 m kg	*2.200	*2.200	*3.900	3.550	*4.700	*4.700	*4.550	*4.550					
	3,0 m kg	*2.200	*2.200	*4.400	3.450	*5.550	4.850	*7.550	*7.550					
	1,5 m kg	*2.300	*2.300	*4.650	3.350	*6.050	4.650	*8.850	7.200					
	0,0 m kg	*2.450	*2.450	*4.900	3.300	*6.600	4.500	*9.550	6.900	*4.900	*4.900			
- 1,5 m kg	*2.850	*2.850	*4.900	3.250	*6.650	4.450	*9.050	6.750	*7.700	*7.700				
- 3,0 m kg	*4.150	3.650			*5.550	4.450	*7.650	6.800						
- 4,5 m kg														

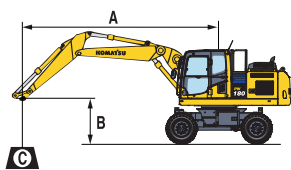

 <p>Outrigger front + rear</p>	2,25 m	7,5 m kg	*3.650	*3.650					*5.450	*5.450				
		6,0 m kg	*3.150	*3.150			*5.200	*5.200	*5.400	*5.400				
		4,5 m kg	*3.000	*3.000	*3.350	*3.350	*5.600	*5.600	*6.500	*6.500	*6.350	*6.350		
		3,0 m kg	*3.000	*3.000	*4.750	4.300	*5.950	*5.950	*8.250	*8.250				
		1,5 m kg	*3.050	*3.050	*4.950	4.200	*6.400	5.850	*9.550	9.050				
		0,0 m kg	*3.350	*3.350	*5.200	4.150	*7.000	5.700	*9.550	8.900				
	- 1,5 m kg	*3.850	*3.850			*6.400	5.650	*8.700	*8.700	*8.250	*8.250			
	- 3,0 m kg													
	- 4,5 m kg													
	2,6 m	7,5 m kg	*3.000	*3.000										
		6,0 m kg	*2.700	*2.700			*4.650	*4.650						
		4,5 m kg	*2.550	*2.550	*3.950	*3.950	*5.400	*5.400	*5.400	*5.400				
3,0 m kg		*2.550	*2.550	*4.600	4.250	*5.700	*5.700	*7.800	*7.800					
1,5 m kg		*2.650	*2.650	*4.800	4.200	*6.200	5.800	*9.300	9.150					
0,0 m kg		*2.900	*2.900	*5.050	3.850	*6.750	5.650	*9.550	8.850					
- 1,5 m kg	*3.350	*3.350	*4.600	4.100	*6.600	5.600	*8.950	8.750	*8.150	*8.150				
- 3,0 m kg	*4.700	*4.700			*5.250	*5.250	*7.300	*7.300						
- 4,5 m kg														
2,9 m	7,5 m kg	*2.550	*2.550			*3.450	*3.450							
	6,0 m kg	*2.300	*2.300			*4.150	*4.150							
	4,5 m kg	*2.200	*2.200	*3.900	*3.900	*4.700	*4.700	*4.550	*4.550					
	3,0 m kg	*2.200	*2.200	*4.400	4.200	*5.550	*5.550	*7.550	*7.550					
	1,5 m kg	*2.300	*2.300	*4.650	4.100	*6.050	5.750	*8.850	*8.850					
	0,0 m kg	*2.450	*2.450	*4.900	4.050	*6.600	5.600	*9.550	8.850	*4.900	*4.900			
- 1,5 m kg	*2.850	*2.850	*4.900	3.750	*6.650	5.550	*9.050	8.700	*7.700	*7.700				
- 3,0 m kg	*4.150	*4.150			*5.550	*5.550	*7.650	*7.650						
- 4,5 m kg														



- A – Reach from swing center
- B – Bucket hook height
- C – Lifting capacities, including bucket linkage (120 kg) and bucket cylinder (109 kg)

When removing linkage or cylinder, lifting capacities can be increased by their respective weights.

\* Load is limited by hydraulic capacity rather than tipping. Ratings are based on SAE Standard No. J1097. Rated loads do not exceed 87% of hydraulic lift capacity or 75% of tipping load.

-  – Rating over front
-  – Rating over side
-  – Rating at maximum reach

# Lifting Capacity

## Mono boom / undercarriage width 2,75 m

Arm length	A B	7,5 m		6,0 m		4,5 m		3,0 m		1,5 m		
 Without stabilizer	2,25 m	7,5 m kg	*3.350	*3.350				*5.150	*5.150			
		6,0 m kg	*3.000	2.700			4.100	3.300	*5.600	5.300		
		4,5 m kg	2.800	2.250	2.800	2.250	4.000	3.250	6.300	5.050	*8.150	*8.150
		3,0 m kg	2.500	2.000	2.700	2.200	3.800	3.100	5.850	4.650		
		1,5 m kg	2.400	1.950	2.650	2.100	3.650	2.850	5.450	4.300		
		0,0 m kg	2.400	1.950	2.550	2.050	3.450	2.800	5.250	4.050		
		- 1,5 m kg	2.650	2.150			3.400	2.700	5.200	4.050	*9.100	7.450
		- 3,0 m kg	3.200	2.600			3.450	2.800	5.250	4.100	*8.500	7.650
		- 4,5 m kg										
	2,6 m	7,5 m kg	*2.750	*2.750								
		6,0 m kg	*2.550	2.550			4.150	3.350				
		4,5 m kg	*2.450	2.100	2.800	2.250	4.050	3.300	*6.050	5.100		
		3,0 m kg	2.350	1.900	2.700	2.200	3.850	3.100	5.900	4.700		
		1,5 m kg	2.250	1.800	2.600	2.100	3.600	2.850	5.450	4.300		
		0,0 m kg	2.250	1.800	2.550	2.000	3.450	2.750	5.200	4.050	*5.600	*5.600
		- 1,5 m kg	2.450	1.950	2.550	2.000	3.400	2.650	5.100	3.950	*8.950	7.300
		- 3,0 m kg	2.900	2.400			3.350	2.700	5.150	4.000	*9.450	7.400
		- 4,5 m kg										
2,9 m	7,5 m kg	*2.350	*2.350			*3.000	*3.000					
	6,0 m kg	*2.150	*2.150			4.100	3.300					
	4,5 m kg	*2.100	1.950	2.750	2.250	4.000	3.250	*5.050	*5.050			
	3,0 m kg	*2.150	1.750	2.650	2.100	3.800	3.050	5.950	4.700	11.600	8.750	
	1,5 m kg	2.100	1.650	2.550	2.050	3.600	2.850	5.500	4.300			
	0,0 m kg	2.100	1.650	2.450	1.950	3.400	2.700	5.200	4.050	*5.750	*5.750	
	- 1,5 m kg	2.250	1.800	2.400	1.950	3.350	2.600	5.100	3.900	*8.500	7.200	
	- 3,0 m kg	2.700	2.100			3.350	2.600	5.100	3.900	10.050	7.350	
	- 4,5 m kg	*4.150	3.450					*4.800	4.050			
 Front or rear blade	2,25 m	7,5 m kg	*3.350	*3.350				*5.150	*5.150			
		6,0 m kg	*3.000	*3.000			4.550	3.800	*5.600	*5.600		
		4,5 m kg	*2.900	2.550	*2.900	2.550	4.450	3.700	6.900	5.750	*8.150	*8.150
		3,0 m kg	2.700	2.300	3.050	2.550	4.250	3.500	6.500	5.350		
		1,5 m kg	2.700	2.250	2.900	2.450	4.050	3.350	6.100	4.950		
		0,0 m kg	2.800	2.250	2.900	2.400	3.950	3.200	5.850	4.750		
		- 1,5 m kg	3.050	2.500			3.900	3.150	5.850	4.700	*9.100	8.750
		- 3,0 m kg	3.700	3.000			3.950	3.200	5.900	4.750	*8.500	*8.500
		- 4,5 m kg										
	2,6 m	7,5 m kg	*2.750	*2.750								
		6,0 m kg	*2.550	*2.550			*4.500	3.800				
		4,5 m kg	*2.450	2.400	3.150	2.550	4.450	3.700	*6.050	5.800		
		3,0 m kg	*2.550	2.200	3.050	2.500	4.250	3.500	6.550	5.400		
		1,5 m kg	2.550	2.100	2.900	2.400	4.050	3.300	6.100	4.950		
		0,0 m kg	2.600	2.100	2.850	2.350	3.900	3.150	5.850	4.700	*5.600	*5.600
		- 1,5 m kg	2.850	2.300	2.850	2.300	3.850	3.100	5.750	4.650	*8.950	8.600
		- 3,0 m kg	3.350	2.750			3.850	3.150	5.800	4.650	*9.450	8.750
		- 4,5 m kg										
2,9 m	7,5 m kg	*2.350	*2.350			*3.000	*3.000					
	6,0 m kg	*2.150	*2.150			*4.100	3.800					
	4,5 m kg	*2.100	*2.100	3.100	2.550	4.450	3.700	*5.050	*5.050			
	3,0 m kg	*2.150	2.000	3.000	2.450	4.050	3.500	6.600	5.400	*12.050	10.200	
	1,5 m kg	*2.300	1.950	2.900	2.400	4.050	3.300	6.150	4.950			
	0,0 m kg	2.400	1.950	2.850	2.250	3.850	3.150	5.850	4.650	*5.750	*5.750	
	- 1,5 m kg	2.600	2.100	2.750	2.250	3.750	3.050	5.700	4.550	*8.500	*8.500	
	- 3,0 m kg	3.100	2.500			3.750	3.050	5.700	4.600	*10.250	8.700	
	- 4,5 m kg	*4.150	4.000					*4.800	4.700			
 Rear outrigger	2,25 m	7,5 m kg	*3.350	*3.350				*5.150	*5.150			
		6,0 m kg	*3.000	*3.000			4.700	4.650	*5.600	*5.600		
		4,5 m kg	*2.900	*2.900	*2.900	*2.900	4.600	4.500	7.150	7.100	*8.150	*8.150
		3,0 m kg	2.950	2.850	3.150	3.150	4.400	4.350	6.750	6.650		
		1,5 m kg	2.850	2.800	3.100	3.050	4.200	4.200	6.300	6.250		
		0,0 m kg	2.900	2.850	3.000	3.000	4.100	4.050	6.100	6.000		
		- 1,5 m kg	3.150	3.100			4.050	4.000	6.050	6.000	*9.100	*9.100
		- 3,0 m kg	3.850	3.750			4.100	4.050	6.150	6.050	*8.500	*8.500
		- 4,5 m kg										
	2,6 m	7,5 m kg	*2.750	*2.750								
		6,0 m kg	*2.550	*2.550			*4.500	*4.500				
		4,5 m kg	*2.450	*2.450	3.250	3.150	4.600	4.550	*6.050	*6.000		
		3,0 m kg	*2.550	*2.550	3.150	3.100	4.400	4.350	6.750	6.700		
		1,5 m kg	2.650	2.600	3.050	3.000	4.200	4.150	6.300	6.250		
		0,0 m kg	2.700	2.650	3.000	2.950	4.050	4.000	6.050	6.000	*5.600	*5.600
		- 1,5 m kg	2.950	2.850	3.000	2.900	4.000	3.900	6.000	5.900	*8.950	*8.950
		- 3,0 m kg	3.500	3.450			4.050	3.950	6.000	5.950	*9.450	*9.450
		- 4,5 m kg										
2,9 m	7,5 m kg	*2.350	*2.350			*3.000	*3.000					
	6,0 m kg	*2.150	*2.150			*4.100	*4.100					
	4,5 m kg	*2.100	*2.100	3.200	3.150	4.600	4.500	*5.050	*5.050			
	3,0 m kg	*2.150	*2.150	3.150	3.050	4.400	4.350	6.800	6.750	*12.050	*12.050	
	1,5 m kg	*2.300	*2.300	3.000	3.000	4.200	4.100	6.350	6.300			
	0,0 m kg	2.550	2.450	2.950	2.850	4.050	3.950	6.050	6.000	*5.750	*5.750	
	- 1,5 m kg	2.700	2.700	2.900	2.850	3.900	3.900	5.950	5.850	*8.500	*8.500	
	- 3,0 m kg	3.200	3.150			3.950	3.900	5.950	5.850	*10.250	*10.250	
	- 4,5 m kg	*4.150	*4.150					*4.800	*4.800			





Arm length	A	⊗		7,5 m		6,0 m		4,5 m		3,0 m		1,5 m		
		⊗	⊗	⊗	⊗	⊗	⊗	⊗	⊗	⊗	⊗	⊗	⊗	
 <p>Outrigger + blade</p>	2,25 m	7,5 m	kg	*3.350	*3.350			*5.150	*5.150					
		6,0 m	kg	*3.000	*3.000			*5.000	*5.000	*5.600	*5.600			
		4,5 m	kg	*2.900	*2.900	*2.900	*2.900	*6.050	5.600	*7.250	*7.250	*8.150	*8.150	
		3,0 m	kg	*2.950	*2.950	*5.000	3.900	*6.550	5.400	*8.600	8.450			
		1,5 m	kg	*3.100	*3.100	*5.500	3.800	*6.950	5.250	*9.550	8.100			
		0,0 m	kg	*3.450	*3.450	5.250	3.750	*7.000	5.100	*9.450	7.850			
		- 1,5 m	kg	*4.150	3.900			*6.400	5.050	*8.600	7.800	*9.100	*9.100	
		- 3,0 m	kg	*4.150	*4.150			*4.700	*4.700	*6.700	*6.700	*8.500	*8.500	
		- 4,5 m	kg											
	2,6 m	7,5 m	kg	*2.750	*2.750									
		6,0 m	kg	*2.550	*2.550			*4.500	*4.500					
		4,5 m	kg	*2.450	*2.450	*3.600	*3.600	*5.550	*5.550	*6.050	*6.050			
		3,0 m	kg	*2.550	*2.550	*4.950	3.900	*6.350	5.400	*8.250	*8.250			
		1,5 m	kg	*2.700	*2.700	*5.450	3.750	*6.800	5.250	*9.300	8.100			
		0,0 m	kg	*3.050	*3.050	5.250	3.700	*6.950	5.050	*9.550	7.800	*5.600	*5.600	
		- 1,5 m	kg	*3.600	*3.600	*4.150	3.650	*6.500	4.950	*8.750	7.700	*8.950	*8.950	
		- 3,0 m	kg	*4.250	*4.200			*5.200	5.000	*7.150	*7.150	*9.450	*9.450	
		- 4,5 m	kg											
	2,9 m	7,5 m	kg	*2.350	*2.350			*3.000	*3.000					
		6,0 m	kg	*2.150	*2.150			*4.100	*4.100					
		4,5 m	kg	*2.100	*2.100	*3.700	*3.700	*4.900	*4.900	*5.050	*5.050			
		3,0 m	kg	*2.150	*2.150	*4.700	3.800	*6.100	5.400	*7.800	*7.800	*12.050	*12.050	
		1,5 m	kg	*2.300	*2.300	*5.350	3.750	*6.650	5.200	*9.100	8.100			
		0,0 m	kg	*2.600	*2.600	5.250	3.600	*6.850	5.000	*9.450	7.800	*5.750	*5.750	
		- 1,5 m	kg	*3.050	*3.050	*4.850	3.600	*6.550	4.950	*8.950	7.650	*8.500	*8.500	*5.100
		- 3,0 m	kg	*4.050	3.950			*5.500	4.950	*7.550	*7.550	*10.250	*10.250	
		- 4,5 m	kg	*4.150	*4.150					*4.800	*4.800			

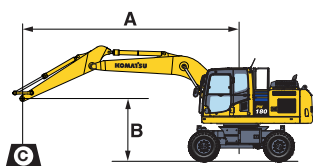

 <p>Outrigger front + rear</p>	2,25 m	7,5 m	kg	*3.350	*3.350			*5.150	*5.150					
		6,0 m	kg	*3.000	*3.000			*5.000	*5.000	*5.600	*5.600			
		4,5 m	kg	*2.900	*2.900	*2.900	*2.900	*6.050	*6.050	*7.250	*7.250	*8.150	*8.150	
		3,0 m	kg	*2.950	*2.950	*5.000	4.800	*6.550	*6.550	*8.600	*8.600			
		1,5 m	kg	*3.100	*3.100	*5.500	4.700	*6.950	6.600	*9.550	*9.550			
		0,0 m	kg	*3.450	*3.450	*5.300	4.650	*7.000	6.450	*9.450	*9.450			
		- 1,5 m	kg	*4.150	*4.150			*6.400	*6.400	*8.600	*8.600	*9.100	*9.100	
		- 3,0 m	kg	*4.150	*4.150			*4.700	*4.700	*6.700	*6.700	*8.500	*8.500	
		- 4,5 m	kg											
	2,6 m	7,5 m	kg	*2.750	*2.750									
		6,0 m	kg	*2.550	*2.550			*4.500	*4.500					
		4,5 m	kg	*2.450	*2.450	*3.600	*3.600	*5.550	*5.550	*6.050	*6.050			
		3,0 m	kg	*2.550	*2.550	*4.950	4.800	*6.350	*6.350	*8.250	*8.250			
		1,5 m	kg	*2.700	*2.700	*5.450	4.700	*6.800	6.600	*9.300	*9.300			
		0,0 m	kg	*3.050	*3.050	*5.350	4.600	*6.950	6.400	*9.550	*9.550	*5.600	*5.600	
		- 1,5 m	kg	*3.600	*3.600	*4.150	*4.150	*6.500	6.300	*8.750	*8.750	*8.950	*8.950	
		- 3,0 m	kg	*4.250	*4.250			*5.200	*5.200	*7.150	*7.150	*9.450	*9.450	
		- 4,5 m	kg											
	2,9 m	7,5 m	kg	*2.350	*2.350			*3.000	*3.000					
		6,0 m	kg	*2.150	*2.150			*4.100	*4.100					
		4,5 m	kg	*2.100	*2.100	*3.700	*3.700	*4.900	*4.900	*5.050	*5.050			
		3,0 m	kg	*2.150	*2.150	*4.700	*4.700	*6.100	*6.100	*7.800	*7.800	*12.050	*12.050	
		1,5 m	kg	*2.300	*2.300	*5.350	4.650	*6.650	6.550	*9.100	*9.100			
		0,0 m	kg	*2.600	*2.600	*5.350	4.550	*6.850	6.350	*9.450	*9.450	*5.750	*5.750	
		- 1,5 m	kg	*3.050	*3.050	*4.850	4.500	*6.550	6.300	*8.950	*8.950	*8.500	*8.500	*5.100
		- 3,0 m	kg	*4.050	*4.050			*5.500	*5.500	*7.550	*7.550	*10.250	*10.250	
		- 4,5 m	kg	*4.150	*4.150					*4.800	*4.800			



- A – Reach from swing center
- B – Bucket hook height
- C – Rating at maximum reach



When removing linkage or cylinder, lifting capacities can be increased by their respective weights.

\* Load is limited by hydraulic capacity rather than tipping. Ratings are based on SAE Standard No. J1097. Rated loads do not exceed 87% of hydraulic lift capacity or 75% of tipping load.

-  – Rating over front
-  – Rating over side
-  – Rating at maximum reach

# Lifting Capacity

## Two-piece boom / undercarriage width 2,75 m

Arm length	A	7,5 m		6,0 m		4,5 m		3,0 m		1,5 m		
 Without stabilizer	2,25 m	7,5 m kg	*3.650	*3.650				*5.450	5.350			
		6,0 m kg	*3.150	2.700			4.100	3.350	*5.400	5.300		
		4,5 m kg	2.750	2.250	2.800	2.250	4.050	3.300	6.300	5.050	*6.350	*6.350
		3,0 m kg	2.550	2.050	2.750	2.250	3.850	3.100	5.900	4.650		
		1,5 m kg	2.400	1.950	2.700	2.150	3.700	2.900	5.550	4.350		
		0,0 m kg	2.450	1.950	2.650	2.100	3.600	2.850	5.350	4.200		
	- 1,5 m kg	2.650	2.200			3.450	2.800	5.300	4.100	*8.250	7.650	
	- 3,0 m kg											
	- 4,5 m kg											
	2,6 m	7,5 m kg	*3.000	*3.000								
		6,0 m kg	*2.700	2.450			4.150	3.350				
		4,5 m kg	*2.550	2.100	2.800	2.250	4.050	3.300	*5.400	5.100		
		3,0 m kg	2.350	1.850	2.700	2.200	3.850	3.100	5.950	4.700		
		1,5 m kg	2.200	1.800	2.650	2.100	3.650	2.900	5.550	4.350		
		0,0 m kg	2.300	1.850	2.600	2.050	3.500	2.800	5.300	4.100		
- 1,5 m kg	2.500	2.000	2.550	2.050	3.450	2.750	5.250	4.050	*8.150	7.450		
- 3,0 m kg	3.250	2.550			3.500	2.800	5.250	4.100				
- 4,5 m kg												
2,9 m	7,5 m kg	*2.550	*2.550			*3.450	3.300					
	6,0 m kg	*2.300	2.250			4.100	3.350					
	4,5 m kg	*2.200	1.900	2.750		4.000	3.250	*4.550	*4.550			
	3,0 m kg	2.150		2.700	2.150	3.800	3.050	6.000	4.750			
	1,5 m kg	2.100	1.650	2.600	2.100	3.600		5.550				
	0,0 m kg	2.150	1.650	2.450		3.450	2.750	5.250	4.100	*4.900	*4.900	
- 1,5 m kg	2.300	1.800	2.500	1.950	3.400		5.150		*7.700	7.400		
- 3,0 m kg	2.800				3.450		5.200					
- 4,5 m kg												
 Front or rear blade	2,25 m	7,5 m kg	*3.650	*3.650				*5.450	*5.450			
		6,0 m kg	*3.150	3.050			4.550	3.800	*5.400	*5.350		
		4,5 m kg	*3.000	2.550	3.150	2.600	4.450	3.700	*6.500	5.750	*6.350	*6.350
		3,0 m kg	2.850	2.350	3.100	2.550	4.100	3.550	6.550	5.350		
		1,5 m kg	2.750	2.250	3.000	2.500	4.100	3.400	6.150	5.000		
		0,0 m kg	2.850	2.300	2.900	2.400	4.000	3.300	6.000	4.800		
	- 1,5 m kg	3.100	2.550			3.950	3.250	5.950	4.800	*8.250	*8.250	
	- 3,0 m kg											
	- 4,5 m kg											
	2,6 m	7,5 m kg	*3.000	*3.000								
		6,0 m kg	*2.700	*2.650			4.550	3.800				
		4,5 m kg	*2.550	2.400	3.150	2.600	4.500	3.750	*5.400	*5.400		
		3,0 m kg	*2.550	2.150	2.950	2.550	4.300	3.550	6.600	5.400		
		1,5 m kg	2.550	2.100	3.000	2.450	4.100	3.350	6.150	5.000		
		0,0 m kg	2.600	2.150	2.900	2.400	3.950	3.250	5.950	4.800		
- 1,5 m kg	2.850	2.350	2.900	2.400	3.900	3.150	5.850	4.700	*8.150	*8.150		
- 3,0 m kg	3.650	3.000			3.950	3.200	5.900	4.800				
- 4,5 m kg												
2,9 m	7,5 m kg	*2.550	*2.550			*3.450	*3.450					
	6,0 m kg	*2.300	*2.300			*4.150	3.800					
	4,5 m kg	*2.200	2.200	3.100	2.550	4.450	3.700	*4.550	*4.550			
	3,0 m kg	*2.200	2.000	2.950	2.500	4.250	3.500	6.600	5.400			
	1,5 m kg	*2.300	1.950	2.950	2.400	4.050	3.300	6.150	5.000			
	0,0 m kg	2.400	1.950	2.850	2.350	3.900	3.150	5.900	4.750	*4.900	*4.900	
- 1,5 m kg	2.650	2.150	2.850	2.300	3.850	3.150	5.850	4.650	*7.700	*7.700		
- 3,0 m kg	3.150	2.550			3.900	3.150	5.850	4.700				
- 4,5 m kg												
 Rear outrigger	2,25 m	7,5 m kg	*3.650	3.500				*5.450	4.950			
		6,0 m kg	*3.150	2.400			4.700	3.000	*5.400	4.750		
		4,5 m kg	*3.000	2.150	3.250	2.050	4.600	3.100	*6.500	4.450	*6.350	*6.350
		3,0 m kg	2.950	1.950	3.200	2.100	4.450	2.900	6.750	4.050		
		1,5 m kg	2.850	1.850	3.150	2.050	4.300	2.700	6.400	3.850		
		0,0 m kg	2.900	1.900	2.850	1.950	4.150	2.650	6.200	3.850		
	- 1,5 m kg	3.200	1.950			4.150	2.650	6.150	3.600	*8.250	6.350	
	- 3,0 m kg											
	- 4,5 m kg											
	2,6 m	7,5 m kg	*3.000	*3.000								
		6,0 m kg	*2.700	2.250			4.450	3.150				
		4,5 m kg	*2.550	1.900	3.250	2.050	4.650	3.000	*5.400	4.500		
		3,0 m kg	*2.550	1.650	3.150	2.100	4.450	2.750	6.800	4.050		
		1,5 m kg	*2.650	1.700	3.100	2.050	4.250	2.650	6.400	3.900		
		0,0 m kg	2.700	1.650	3.050	1.800	4.100	2.550	6.150	3.750		
- 1,5 m kg	3.000	1.850	3.000	1.950	4.050	2.450	6.100	3.700	*8.150	6.450		
- 3,0 m kg	3.800	2.250			4.100	2.500	6.150	3.600				
- 4,5 m kg												
2,9 m	7,5 m kg	*2.550	*2.550			*3.450	3.100					
	6,0 m kg	*2.300	2.100			*4.150	3.000					
	4,5 m kg	*2.200	1.850	3.200	2.100	4.600	2.850	*4.550	*4.550			
	3,0 m kg	*2.200	1.550	3.150	2.050	4.400	2.750	6.850	4.200			
	1,5 m kg	*2.300	1.600	3.050	1.950	4.200	2.550	6.400	3.800			
	0,0 m kg	*2.450	1.650	3.000	1.900	4.050	2.550	6.150	3.550	*4.900	*4.900	
- 1,5 m kg	2.750	1.700	2.950	1.850	4.000	2.450	6.050	3.400	*7.700	6.300		
- 3,0 m kg	3.300	2.100			4.050	2.550	6.050	3.500				
- 4,5 m kg												



Arm length	A	⊗		7,5 m		6,0 m		4,5 m		3,0 m		1,5 m	
		⊗	⊗	⊗	⊗	⊗	⊗	⊗	⊗	⊗	⊗	⊗	⊗
 <p>Outrigger + blade</p>	2,25 m	7,5 m	kg	*3.650	*3.650					*5.450	*5.450		
		6,0 m	kg	*3.150	*3.150			*5.200	*5.200	*5.400	*5.400		
		4,5 m	kg	*3.000	*3.000	*3.350	*3.350	*5.600	*5.600	*6.500	*6.500	*6.350	*6.350
		3,0 m	kg	*3.000	*3.000	*4.750	3.900	*5.950	5.450	*8.250	*8.250		
		1,5 m	kg	*3.050	*3.050	*4.950	3.850	*6.400	5.300	*9.550	8.150		
		0,0 m	kg	*3.350	*3.350	*5.200	3.800	*7.000	5.150	*9.550	7.950		
		-1,5 m	kg	*3.850	*3.850			*6.400	5.100	*8.700	7.950	*8.250	*8.250
		-3,0 m	kg										
	-4,5 m	kg											
	2,6 m	7,5 m	kg	*3.000	*3.000								
		6,0 m	kg	*2.700	*2.700			*4.650	*4.650				
		4,5 m	kg	*2.550	*2.550	*3.950	*3.950	*5.400	*5.350	*5.400	*5.400		
		3,0 m	kg	*2.550	*2.550	*4.600	3.900	*5.700	5.450	*7.800	*7.800		
		1,5 m	kg	*2.650	*2.650	*4.800	3.800	*6.200	5.250	*9.300	8.150		
		0,0 m	kg	*2.900	*2.900	*5.050	3.750	*6.750	5.100	*9.550	7.950		
		-1,5 m	kg	*3.350	*3.350	*4.600	3.750	*6.600	5.100	*8.950	7.800	*8.150	*8.150
		-3,0 m	kg	*4.700	*4.650			*5.250	5.100	*7.300	*7.200		
	-4,5 m	kg											
	2,9 m	7,5 m	kg	*2.550	*2.550			*3.450	*3.450				
		6,0 m	kg	*2.300	*2.300			*4.150	*4.150				
		4,5 m	kg	*2.200	*2.200	*3.900	*3.900	*4.700	*4.700	*4.550	*4.550		
		3,0 m	kg	*2.200	*2.200	*4.400	3.850	*5.550	5.450	*7.550	*7.550		
		1,5 m	kg	*2.300	*2.300	*4.650	3.750	*6.050	5.250	*8.850	8.150		
		0,0 m	kg	*2.450	*2.450	*4.900	3.700	*6.600	5.100	*9.550	7.850	*4.900	*4.900
-1,5 m		kg	*2.850	*2.850	*4.900	3.650	*6.650	5.000	*9.050	7.800	*7.700	*7.700	
-3,0 m		kg	*4.150	4.100			*5.550	5.050	*7.650	*7.650			
-4,5 m	kg												

 <p>Outrigger front + rear</p>	2,25 m	7,5 m	kg	*3.650	*3.650					*5.450	*5.450		
		6,0 m	kg	*3.150	*3.150			*5.200	*5.200	*5.400	*5.400		
		4,5 m	kg	*3.000	*3.000	*3.350	*3.350	*5.600	*5.600	*6.500	*6.500	*6.350	*6.350
		3,0 m	kg	*3.000	*3.000	*4.750	*4.750	*5.950	*5.950	*8.250	*8.250		
		1,5 m	kg	*3.050	*3.050	*4.950	4.800	*6.400	*6.400	*9.550	*9.550		
		0,0 m	kg	*3.350	*3.350	*5.200	4.700	*7.000	6.550	*9.550	*9.550		
		-1,5 m	kg	*3.850	*3.850			*6.400	*6.400	*8.700	*8.700	*8.250	*8.250
		-3,0 m	kg										
	-4,5 m	kg											
	2,6 m	7,5 m	kg	*3.000	*3.000								
		6,0 m	kg	*2.700	*2.700			*4.650	*4.650				
		4,5 m	kg	*2.550	*2.550	*3.950	*3.950	*5.400	*5.400	*5.400	*5.400		
		3,0 m	kg	*2.550	*2.550	*4.600	*4.600	*5.700	*5.700	*7.800	*7.800		
		1,5 m	kg	*2.650	*2.650	*4.800	4.750	*6.200	*6.200	*9.300	*9.300		
		0,0 m	kg	*2.900	*2.900	*5.050	4.650	*6.750	6.500	*9.550	*9.550		
		-1,5 m	kg	*3.350	*3.350	*4.600	*4.600	*6.600	6.450	*8.950	*8.950	*8.150	*8.150
		-3,0 m	kg	*4.700	*4.700			*5.250	*5.250	*7.300	*7.300		
	-4,5 m	kg											
	2,9 m	7,5 m	kg	*2.550	*2.550			*3.450	*3.450				
		6,0 m	kg	*2.300	*2.300			*4.150	*4.150				
		4,5 m	kg	*2.200	*2.200	*3.900	*3.900	*4.700	*4.700	*4.550	*4.550		
		3,0 m	kg	*2.200	*2.200	*4.400	*4.400	*5.550	*5.550	*7.550	*7.550		
		1,5 m	kg	*2.300	*2.300	*4.650	*4.650	*6.050	*6.050	*8.850	*8.850		
		0,0 m	kg	*2.450	*2.450	*4.900	4.600	*6.600	6.450	*9.550	*9.550	*4.900	*4.900
-1,5 m		kg	*2.850	*2.850	*4.900	4.600	*6.650	6.350	*9.050	*9.050	*7.700	*7.700	
-3,0 m		kg	*4.150	*4.150			*5.550	*5.550	*7.650	*7.650			
-4,5 m	kg												

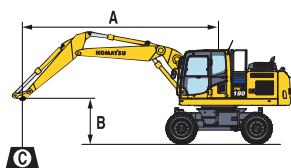

- A – Reach from swing center
- B – Bucket hook height
- C – Lifting capacities, including bucket linkage (120 kg) and bucket cylinder (109 kg)

When removing linkage or cylinder, lifting capacities can be increased by their respective weights.

\* Load is limited by hydraulic capacity rather than tipping. Ratings are based on SAE Standard No. J1097. Rated loads do not exceed 87% of hydraulic lift capacity or 75% of tipping load.

-  – Rating over front
-  – Rating over side
-  – Rating at maximum reach



# Hydraulic Wheeled Excavator

## PW180-10

### Standard and Optional Equipment

#### ENGINE

Komatsu SAA6D107E-2 turbocharged common rail direct injection diesel engine	●
EU Stage IIIB/EPA Tier 4 interim compliant	●
Suction type cooling fan	●
Automatic engine warm-up system	●
Engine overheat prevention system	●
Fuel control dial	●
Auto-deceleration function	●
Engine ignition can be password secured on request	●
Batteries 2 × 12 V/155 Ah	●

#### SAFETY EQUIPMENT

Rear view camera system	●
Electric horn	●
Overload warning device	●
Lockable fuel cap and covers	●
Audible travel alarm	●
Large handrails, rear-view mirrors	●
Battery main switch	●
Boom safety valves	●
Arm safety valve	●
Adjust cylinder safety valve	●
OPG Level II front guard (FOPS)	○
OPG Level II top guard (FOPS)	○
Audible travel alarm (white noise version)	○
Side view camera system	○
Super tone horn (no road approval)	○

#### SERVICE AND MAINTENANCE

Automatic fuel line de-aeration	●
Double element type air cleaner with dust indicator and auto dust evacuator	●
KOMTRAX™ – Komatsu wireless monitoring system	●
Multi-function video compatible colour monitor with Equipment Management and Monitoring System (EMMS) and efficiency guidance	●
Toolkit	●
Komatsu CARE	●
Centralised greasing system	●
Automatic greasing system	○

#### CABIN

SpaceCab™; Highly pressurised and tightly sealed hyper viscous mounted cab with tinted safety glass windows, large roof window with sun shade, pull-up type front window with locking device, removable lower window, front window wiper with intermittent feature, sun roller blind, cigarette lighter, ashtray, luggage shelf, floor mat	●
Heated air suspension seat with lumbar support, height adjustable arm rests and retractable seat belt	●
Automatic climate control system	●
12/24 Volt power supplies	●
Beverage holder and magazine rack	●
Hot and cool box	●
Auxiliary input (MP3 jack)	●
CD radio	○
Adjustable, suspended seat	○
Lower wiper	○
Rain visor (not with OPG)	○

#### HYDRAULIC SYSTEM

Electronic closed-centre load sensing (E-CLSS) hydraulic system (HydrauMind)	●
Pump and engine mutual control (PEMC) system	●
6-working mode selection system; power mode, economy mode, breaker mode, attachment power and attachment economy mode, and lifting mode	●
PowerMax function	●
Adjustable PPC wrist control levers for arm, boom, bucket and swing, with sliding proportional control for attachments and 5 auxiliary buttons, with FNR switch	●
1. additional hydraulic circuit (HCU-B)	●
2. additional hydraulic circuit (HCU-D)	○
Prepared for hydraulic quick-coupler	○

#### OTHER EQUIPMENT

Electric refuelling pump with automatic shut off function	●
Single chassis tool box (245 ltr)	●
Additional chassis tool box (245 ltr)	○
Biodegradable oil for hydraulic system	○
Customised paint	○

#### UNDERCARRIAGE

Parallel blade (front and/or rear) with cylinder protection	○
2 or 4 outriggers with cylinder protection, individually adjustable	○
Twin tyres 10.00-20 16 PR	○
Twin tyres Bandenmarkt Excavator 315/70 R22.5	○
Twin tyres Nokian 10-20 (L5)	○
Single tyres Michelin 18.00-19.5	○
Tyres Bandenmarkt Grader 315/70 R22.5	○
Fenders	○

#### DRIVES AND BRAKES

Fully automatic 3-speed transmission driving through front and rear planetary axles	●
Oscillating front axle (10°) with automatic and manual cylinder locking	●
Cruise control	●
2,55 m wide undercarriage	●
2,75 m wide undercarriage	○
20 or 25 km/h speed limitation	○
Transmission guard	○

#### LIGHTING SYSTEM

Working lights: 2 revolving frame, 1 counterweight (rear), 1 boom (LH)	●
Additional RH boom lamp	○
LED working lights	○
Beacon + rear facing cab lamp	○
1 or 2 additional beacons on counterweight	○
Additional large capacity cab roof lights (4)	○

#### WORK EQUIPMENT

Mono boom	○
Two-piece boom	○
2,25 m; 2,6 m; 2,9 m arms	○
Clamshell grip bar	○

Further equipment on request

- standard equipment
- optional equipment

Your Komatsu partner:

# KOMATSU

**Komatsu Europe  
International NV**  
Mechelsesteenweg 586  
B-1800 VILVOORDE (BELGIUM)  
Tel. +32-2-255 24 11  
Fax +32-2-252 19 81  
[www.komatsu.eu](http://www.komatsu.eu)

VENSS04700 07/2013

Materials and specifications are subject to change without notice.  
**KOMATSU** is a trademark of Komatsu Ltd. Japan.