

KOMATSU

PC
210LCi



intelligent
MACHINE CONTROL

Hydraulic Excavator **PC210LCi-10**

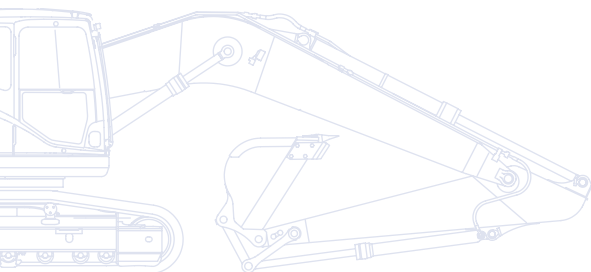

ENGINE POWER
123 kW / 165 HP @ 2.000 rpm

OPERATING WEIGHT
22.410 - 23.340 kg

BUCKET CAPACITY
max. 1,68 m³

Walk-Around

The Komatsu PC210LCi-10 is the world's first intelligent Machine Control excavator. It features Komatsu's revolutionary machine control and guidance system, fully factory integrated with the other qualities and benefits of the standard Komatsu PC210LC-10 excavator. The exclusive control function lets you focus on moving material efficiently, with no worry about digging too deep or damaging the target surface. From rough digging to finish grading, the PC210LCi-10 excavator drastically improves efficiency, precision and safety on your work sites. Hydraulic excavators will never be the same again.

Total versatility

- Ideal for a wide range of applications
- 6 working modes
- Wide choice of options
- Built-in versatility

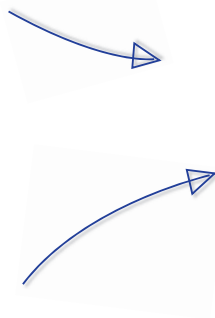

Powerful and environmentally friendly

- Low consumption EU Stage IIIB engine
- Fuel-saving engine and hydraulic technology
- Adjustable Eco-gauge and idle caution
- Reduced wastage



Complimentary maintenance program for customers



Komatsu Wireless Monitoring System

PC210LCi-10

ENGINE POWER
123 kW / 165 HP @ 2.000 rpm

OPERATING WEIGHT
22.410 - 23.340 kg

BUCKET CAPACITY
max. 1,68 m³

Intelligent Machine Control

- Innovative – Integrated – Intelligent
- Automatic real time digging control
- Drastically improved efficiency
- Intelligent touch screen monitor
- Factory installed components

First-class operator comfort

- Fully air suspended operator station
- Low noise design
- Low vibration levels
- Large, widescreen hi-res display monitor
- Improved operator convenience

Quality you can rely on

- Reliable and efficient
- Rugged design
- Komatsu-quality components
- Extensive dealer support network

Highest safety standards

- Safe SpaceCab™
ROPS compliant with ISO 12117-2:2008
- Low profile rear view camera
- Optimal jobsite safety
- Safe access, easy maintenance
- Falling Object Protection System (FOPS) optional



Intelligent Machine Control

Innovative

The PC210LCi-10 provides an outstanding improvement in productivity. It performs accurate rough digging, and completes final grade automatically, in just one pass. Cycle times and operator performance are improved, with a reduced risk of error and lower costs for fuel, labour and machine utilisation.

Automatic real time digging control

Komatsu intelligent Machine Control is based on Komatsu's unique sensor development, stroke sensing hydraulic cylinders and IMU sensor. You will no longer worry about over digging. When your bucket hits the target surface, the control function automatically limits it and maintains grade with real-time bucket edge positioning.





Drastically improved efficiency

Komatsu intelligent Machine Control lets you work quickly and easily, with no fear of over-digging. Efficiency and accuracy are greatly improved, as you can consistently achieve high bucket fills. With the “minimum distance” function, the PC210LCi-10 controls the bucket by automatically selecting the point on the bucket closest to the target surface. The surface is always protected.

Higher safety

Staking, surveying and final inspection were usually done manually. The PC210LCi-10 reduces or eliminates the need for this ground staff around the machine. GNSS antennae integrated in the handrails remove the need to access the top of the counterweight.



Intelligent Machine Control

Integrated – Factory installed components

The machine control and guidance system on the PC210LCi-10 is fully factory integrated. Stroke sensing hydraulic cylinders for the boom, arm and bucket, were newly developed by Komatsu for precise real time bucket edge positioning. An IMU (Inertial Measuring Unit) gives precise machine orientation and determines machine angle from gyro and accelerometer data. GNSS antennae are integrated into the hand rails.

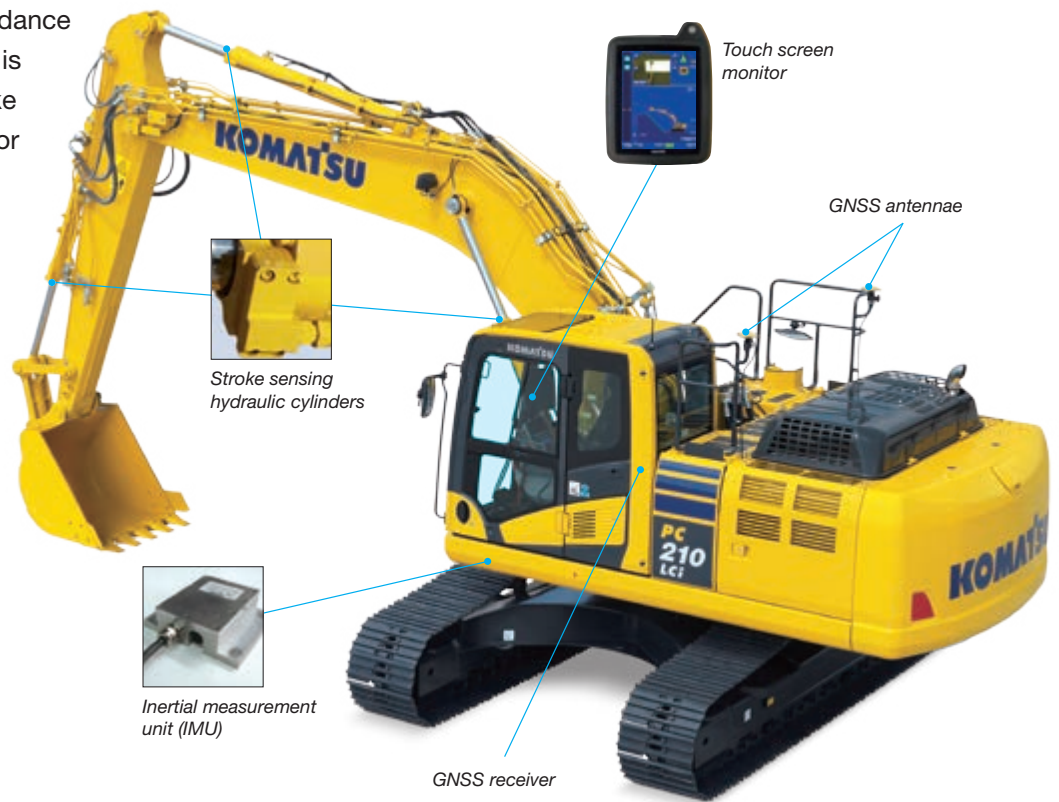

Complete job site management

Remote assistance from Komatsu with Client Support is standard. Additionally, with Sitelink 3D Enterprise (an option from Topcon) you can transmit design data from the office to the machine and receive progress information and as-built data from the machine in real time.





Intelligent

The Komatsu PC210LCi-10 intelligent Machine Control excavator lets you focus on moving material efficiently, with no worry about digging too deep. Even with just the machine guidance function, operations are completed quicker thanks to the monitor's "real time" view, which offers high accuracy, shorter working hours and reduced costs for the job.



Intelligent touch screen monitor

The large 12,1" touch screen control box monitor features a realistic display of the machine and surfaces in 3D. You may select the optimal view, depending on work conditions. The orientation of the unique facing angle compass arrow indicates the position of the bucket edge in relation to the design surface. A coloured light bar shows the bucket edge position relative to the design surface.

Powerful and Environmentally Friendly

New Komatsu engine technology

The powerful and fuel-efficient Komatsu SAA6D107E-2 engine in the PC210LCi-10 delivers 123 kW / 165 HP and is EU Stage IIIB certified. To maximise power, fuel efficiency and emission compliance, it is turbo charged and features direct fuel injection, air-to-air after cooling and cooled EGR.

Fuel-saving engine and hydraulic technology

The PC210LCi-10 features variable speed matching of the engine and hydraulic pump, and an automatic low idle. The new engine and pump control technology lower total fuel consumption and guarantee efficiency and precision during single and combined movements.



Komatsu Diesel Particulate Filter (KDPF)

Komatsu's high efficiency DPF captures more than 90% of particulate matter. It includes a special oxidation catalyst with fuel injection system that can incinerate trapped particulates by either active or passive regeneration with no need to interrupt machine operations.

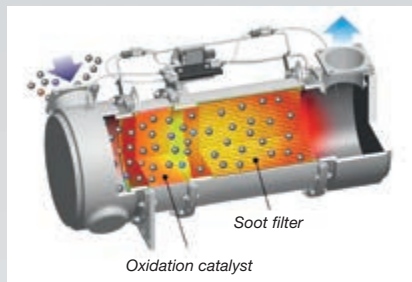

Exhaust Gas Recirculation (EGR)

Cooled EGR is a technology well-proven in current Komatsu engines. The increased capacity of the EGR cooler now ensures very low NOx emissions and a better engine performance.

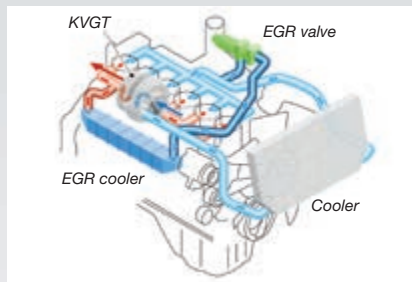

Komatsu Variable Geometry Turbo (KVGT)

The KVGT provides optimal air flow to the engine combustion chamber under all speed and load conditions. Exhaust gas is cleaner, fuel economy is improved while machine power and performance are maintained.

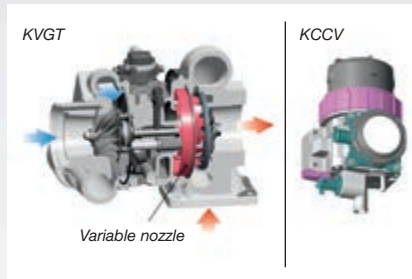

Komatsu Closed Crankcase Ventilation (KCCV)

Crankcase emissions (blow-by gas) are passed through a CCV filter. The oil mist trapped in the filter is returned back to the crankcase while the filtered gas is returned to the air intake.

High-Pressure Common Rail (HPCR)

To achieve complete fuel burn and lower exhaust emissions, the heavy duty High-Pressure Common Rail fuel injection system is computer controlled to deliver a precise quantity of pressurised fuel into the redesigned engine combustion chamber by multiple injections.

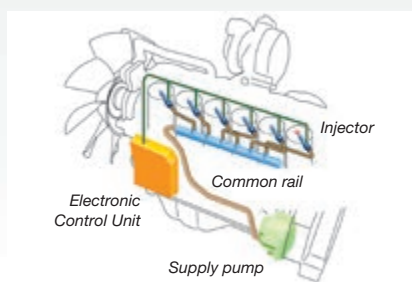

Reduced wastage

Standard equipment on all PC210LCi-10 includes an electric fuel pump, simple to operate and with an automatic shut-off. To further increase the system's safety, a barrier and special foams help to avoid any spilt fuel flowing towards hot areas of the machine.



Eco-gauge and idle caution

The unique ECO-gauge helps the operator reduce emissions and fuel consumption for environmentally friendly and energy saving operations. And to further avoid wasting fuel when the machine is not actually working, a standard-fit idle caution is displayed if the engine idles for 5 minutes or more.



Active ECO recommendations



ECO guidance menu

Total Versatility

Ideal for a wide range of applications

Powerful and precise, the Komatsu PC210LCi-10 is equipped to efficiently carry out any task your business requires. On big sites or small, for digging, trenching, landscaping or site preparation, the Komatsu hydraulic system always ensures maximum productivity and control.

6 working modes

Power, Lifting, Breaker, Economy, Attachment Power and Attachment Economy modes are all available, ensuring that the PC210LCi-10 delivers the power you need with minimised fuel usage. The Economy mode can be adjusted for an ideal balance between power and economy to match your work. The oil flow delivered to hydraulic attachments is adjustable directly on the class-leading wide screen monitor panel.

Built-in versatility

A standard fit additional hydraulic circuit, controlled by a sliding joystick push button and a floor mounted pedal, gives the PC210LCi-10 excellent versatility. Ten attachment memory settings are provided, with individually definable names. In combination with the standard-fit hydraulic quick coupler power circuit, changing working style is now even simpler. A second auxiliary hydraulic line is available for attachments which require extra hydraulic actuation.

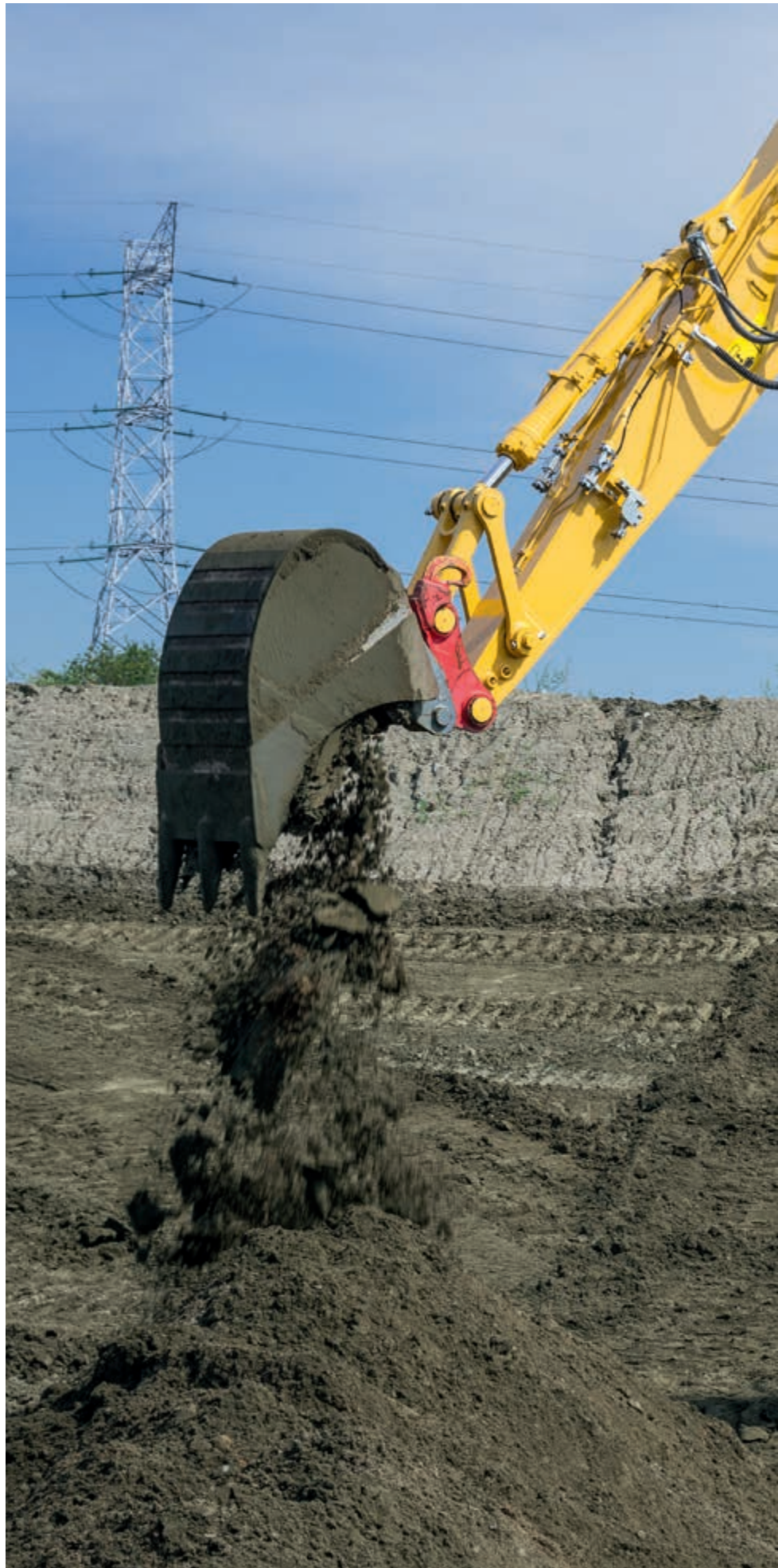



First-Class Operator Comfort

Newly designed, spacious cab

The wide spacious cab features a new, fully air suspended operator control station that incorporates the side consoles mounted together with a high back, fully adjustable seat, heated for improved comfort.

Improved operator convenience

With increased in-cab storage space, an auxiliary input (MP3 jack) and 12 V and 24 V power supply, the cab offers maximum convenience. The automatic air conditioner allows the operator to easily and precisely set the cab's atmosphere.

Cab damper mounting

The built-in stability of the Komatsu PC210LCi-10, combined with a highly rigid deck and a sprung multi-layer viscous mount system, drastically reduces vibration levels for the operator.

Low noise design

Komatsu Dash 10 crawler excavators have very low external noise levels and are especially well-suited for work in confined spaces or urban areas. Reduced fan speed, a large capacity radiator, and the optimal usage of sound insulation and of sound absorbing materials help to make noise levels inside Dash 10 excavators comparable to those inside an executive car.

Large, widescreen hi-res display monitor

To enable safe, accurate and smooth work, the user friendly monitor is the highly intuitive user interface for the machine's Equipment Management and Monitoring System (EMMS). Easily customized and with a choice of 25 languages, it features simple switches and multifunction keys that provide the operator with fingertip access to a wide range of functions and operating information.



Large, widescreen hi-res display monitor



Joysticks with proportional control button for attachments





Highest Safety Standards

Safe SpaceCab™

The new cab is ROPS compliant with ISO 12117-2:2008. It has a tubular steel frame and provides very high shock absorbency, impact resistance and durability. The seat belt is designed to keep the operator in the safety zone of the cab in the event of a roll-over. Optionally it can be fitted with an ISO 10262 Level 2 Falling Object Protective System (FOPS) with openable front guard.

Rear view camera

A standard fitment camera gives an exceptionally clear view of the rear work zone on the wide-screen monitor panel. The low profile camera is adjustable and integrated into the counterweight's shape. On request, another camera can be added to the right side of the machine.

Optimal job site safety

Safety features on the Komatsu PC210LCi-10 comply with the latest industry standards and work together as a system to minimise risks to personnel in and around the machine. An audible travel alarm further promotes job site safety. Highly durable anti-slip plates – with additional high friction covering – maintain long term traction performance.

Safe and easy maintenance

Thermal guards are placed around high temperature parts of the engine. The fan belt and pulleys are well protected and in case of damage, fire risk is reduced by a pump/engine partition that prevents hydraulic oil from spraying onto the engine. The engine hood is hinged to the rear, with anti-slip plates positioned around the engine bay to ensure safe and easy access from all sides. Exceptionally sturdy handrails further contribute to a high safety level.



Low profile rear view camera



Falling Object Protection System (FOPS) optional

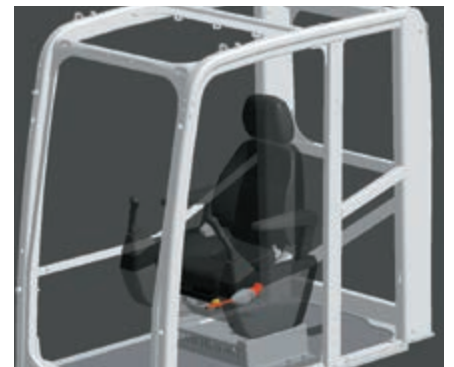

Safe SpaceCab™



Large handrails



Anti-slip plates



Cast boom foot

Reliable and efficient

Productivity is the key to success – all major components of the PC210LCi-10 are designed and directly manufactured by Komatsu. Essential machine functions are perfectly matched for a highly reliable and productive machine.

Komatsu-quality components

With the latest computer design techniques and a thorough test programme, Komatsu's global know-how produces machines that are designed, manufactured and tested to meet your highest standards.



Single piece boom plates

Rugged design

Maximum toughness and durability – along with top class customer service – are the cornerstones of Komatsu's philosophy. Single piece plates and castings are used in key areas of the machine's structure for good load distribution. Highly durable rubbing strips on the underside of the arm protect the structure against material falling from the bucket.

Extensive dealer support network

The extensive Komatsu distribution and dealer network is standing by to help keep your fleet in optimum condition. Customised servicing packages are available, with express availability of spare parts, to make sure that your Komatsu will continue to perform at its peak.



Komatsu Wireless Monitoring System

The easy way to higher productivity

KOMTRAX™ is the latest in wireless monitoring technology. It delivers insightful and cost saving information about your fleet and equipment and offers you a wealth of information to facilitate peak machine performance. By creating a tightly integrated web of support it allows pro active and preventive maintenance and helps you to efficiently run a business.

Knowledge

You get quick answers to basic and critical questions about your machines – what they're doing, when they did it, where they're located, how they can be used more efficiently, and when they need to be serviced. Performance data is relayed by mobile phone technology from your machine to your computer and to your local Komatsu distributor – who's readily available for expert analysis and feedback.

Convenience

KOMTRAX™ helps to conveniently manage your fleet on the web, wherever you are. Data is analysed and packaged specifically for easy and intuitive viewing in maps, lists, graphs and charts. You can anticipate the type of service and parts your machines could require, or troubleshoot problems before Komatsu technicians arrive on site.

Power

The detailed information that KOMTRAX™ puts at your fingertips 24 hours a day, 7 days a week gives you the power to make better daily and long-term strategic decisions. You can anticipate problems, customize maintenance schedules, minimize downtime and keep your machines where they belong – working on the job site.

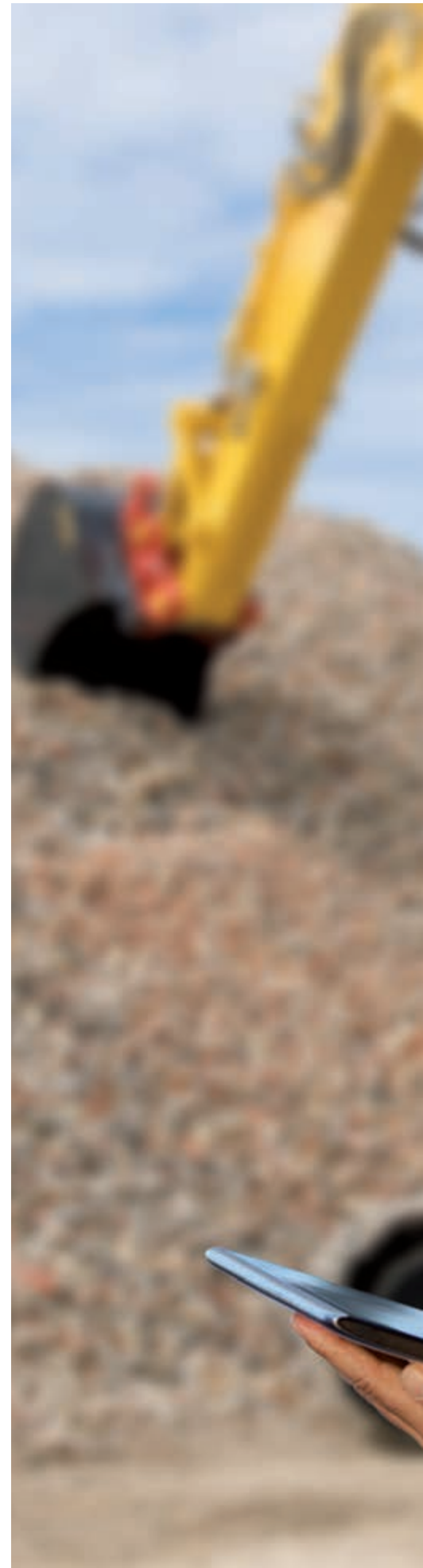



Easy Maintenance

Easy cleaning of coolers

Hinged air conditioning cooler and side-by-side radiator and oil cooler allow easy access for cleaning.



Quick access to filters and fuel drain valve

The engine oil filter, the fuel filters and the fuel drain valve are mounted remotely to make them accessible from ground level.

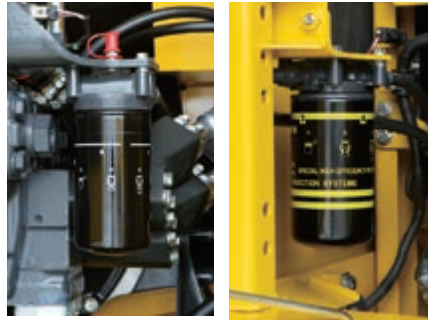

Diesel particulate filter regeneration

Soot trapped in the diesel particulate filter is periodically and automatically oxidized using the heat from the engine exhaust.



Komatsu CARE is a complimentary maintenance program for Komatsu customers that comes as standard with every new Komatsu EU Stage IIIB construction machine. For the first 3 years or 2,000 hours it covers factory-scheduled maintenance, performed by Komatsu-trained technicians with Komatsu Genuine parts. It also offers up to a maximum of 2 complimentary Komatsu Diesel Particulate Filter (KDPF) exchange units and a KDPF warranty for the first 5 years or 9,000 hours.

Water separator

This is standard equipment which removes any water that has become mixed with the fuel, preventing fuel system damage.



Long-life oil filters

The hydraulic oil filter uses high-performance filtering material for long element replacement intervals, which significantly reduces maintenance costs.



ENGINE

Model	Komatsu SAA6D107E-2
Type	Common rail direct injection, water-cooled, emissionised, turbocharged, after-cooled diesel
Engine power	
at rated engine speed	2.000 rpm
ISO 14396	123 kW / 165 HP
ISO 9249 (net engine power)	118 kW / 158 HP
No. of cylinders	6
Bore x stroke	107 x 124 mm
Displacement	6,69 ltr
Battery	2 x 12 V/155 Ah
Alternator	24 V/60 A
Starter motor	24 V/5,5 kW
Air filter type	Double element type with monitor panel dust indicator and auto dust evacuator
Cooling	Suction type cooling fan with radiator fly screen

HYDRAULIC SYSTEM

Type	HydrauMind. Closed-centre system with load sensing and pressure compensation valves
Additional circuits	2 additional circuits with proportional control can be installed
Main pump	2 variable displacement piston pumps supplying boom, arm, bucket, swing and travel circuits
Maximum pump flow	2 x 237,5 ltr/min
Relief valve settings	
Implement	380 kg/cm ²
Travel	380 kg/cm ²
Swing	295 kg/cm ²
Pilot circuit	33 kg/cm ²

UNDERCARRIAGE

Construction	X-frame centre section with box section track frames
Track assembly	
Type	Fully sealed
Shoes (each side)	49
Tension	Combined spring and hydraulic unit
Rollers	
Track rollers (each side)	9
Carrier rollers (each side)	2

OPERATING WEIGHT (APPR.)

	MONO BOOM	
	Operating weight	Ground pressure
Triple grouser shoes		
600 mm	22.410 kg	0,47 kg/cm ²
700 mm	22.690 kg	0,41 kg/cm ²
800 mm	23.010 kg	0,36 kg/cm ²
900 mm	23.340 kg	0,33 kg/cm ²

Operating weight, including specified work equipment, 2,9 m arm, 0,8 m³ bucket, operator, lubricant, coolant, full fuel tank and the standard equipment.

SWING SYSTEM

Type	Axial piston motor driving through planetary double reduction gearbox
Swing lock	Electrically actuated wet multi-disc brake integrated into swing motor
Swing speed	0 - 12,4 rpm
Swing torque	64,6 kNm
Max. pressure	295 kg/cm ²

DRIVES AND BRAKES

Steering control	2 levers with pedals giving full independent control of each track
Drive method	Hydrostatic
Travel operation	Automatic 3-speed selection
Gradeability	70%, 35°
Max. travel speeds	
Lo / Mi / Hi	3,0 / 4,1 / 5,5 km/h
Maximum drawbar pull	20.600 kg
Brake system	Hydraulically operated discs in each travel motor

SERVICE REFILL CAPACITIES

Fuel tank	400 ltr
Radiator	30,7 ltr
Engine oil	23,1 ltr
Swing drive	6,5 ltr
Hydraulic tank	132 ltr
Final drive (each side)	5,0 ltr

ENVIRONMENT

Engine emissions	Fully complies with EU Stage IIIB exhaust emission regulations
Noise levels	
LwA external	102 dB(A) (2000/14/EC Stage II)
LpA operator ear	69 dB(A) (ISO 6396 dynamic test)
Vibration levels (EN 12096:1997)*	
Hand/arm	≤ 2,5 m/s ² (uncertainty K = 0,49 m/s ²)
Body	≤ 0,5 m/s ² (uncertainty K = 0,24 m/s ²)

* for the purpose of risk assessment under directive 2002/44/EC, please refer to ISO/TR 25398:2006.

Dimensions & Performance Figures

MACHINE DIMENSIONS

A	Overall width of upper structure	2.850 mm
B	Overall height (top of cab)	3.045 mm
	Overall height (handrail)	3.135 mm
C	Overall length of basic machine	5.135 mm
D	Tail length	2.910 mm
	Tail swing radius	2.940 mm
E	Clearance under counterweight	1.085 mm
F	Machine tail height	2.250 mm
G	Ground clearance	440 mm
H	Tumbler centre distance	3.655 mm
I	Track length	4.450 mm
J	Track gauge	2.380 mm
K	Track shoe width	600, 700, 800, 900 mm
L	Overall track width with 600 mm shoes	2.980 mm
	Overall track width with 700 mm shoes	3.080 mm
	Overall track width with 800 mm shoes	3.180 mm
	Overall track width with 900 mm shoes	3.280 mm

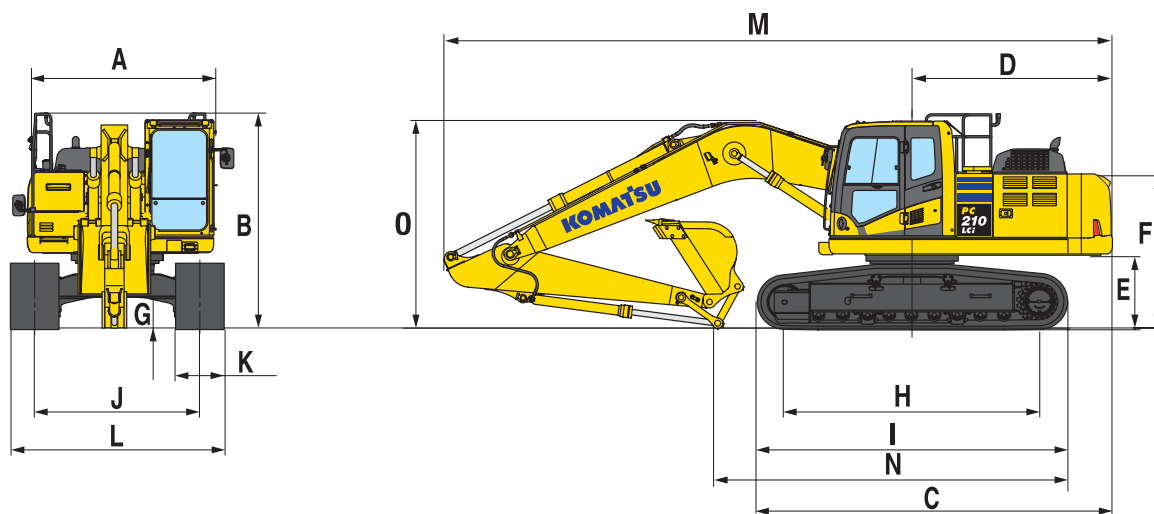

TRANSPORT DIMENSIONS

	Arm length	2,9 m
M	Transport length	9.625 mm
N	Length on ground (transport)	5.000 mm
O	Overall height (to top of boom)	2.995 mm



MAX. BUCKET CAPACITY AND WEIGHT

	MONO BOOM
Arm length	2,9 m
Material weight up to 1,2 t/m ³	1,65 m ³ 1.150 kg
Material weight up to 1,5 t/m ³	1,40 m ³ 1.025 kg
Material weight up to 1,8 t/m ³	1,22 m ³ 925 kg

Max. capacity and weight have been calculated according to ISO 10567:2007.

Please consult with your distributor for the correct selection of buckets and attachments to suit the application.

BUCKET AND ARM FORCE

Arm length	2,9 m
Bucket digging force	14.100 kg
Bucket digging force at PowerMax	15.200 kg
Arm crowd force	10.300 kg
Arm crowd force at PowerMax	11.000 kg



Working Range

MONO BOOM

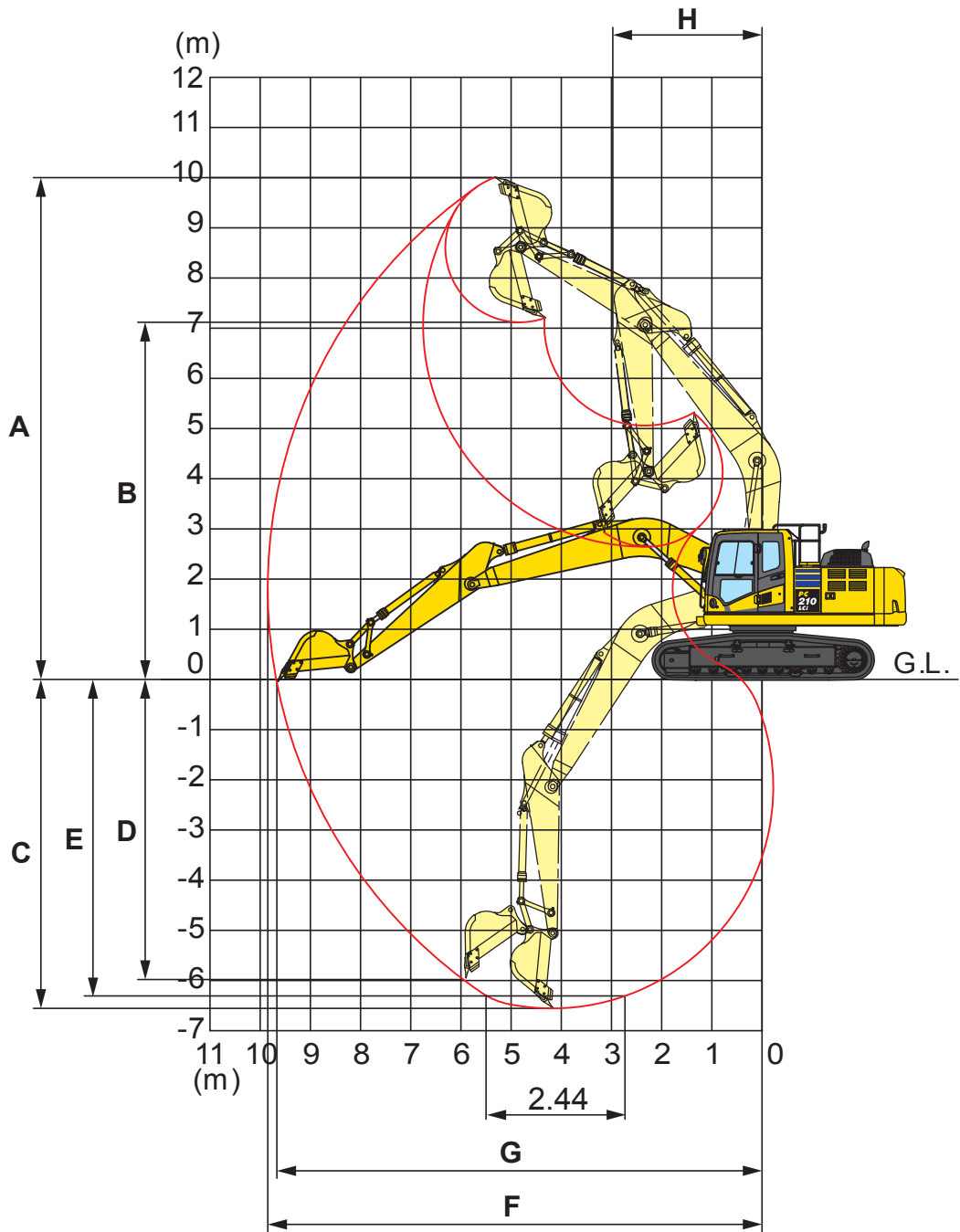

ARM LENGTH		2,9 m
A	Max. digging height	10.000 mm
B	Max. dumping height	7.110 mm
C	Max. digging depth	6.620 mm
D	Max. vertical wall digging depth	5.980 mm
E	Max. digging depth of cut for 2,44 m level	6.370 mm
F	Max. digging reach	9.875 mm
G	Max. digging reach at ground level	9.700 mm
H	Min. swing radius	3.040 mm

MONO BOOM

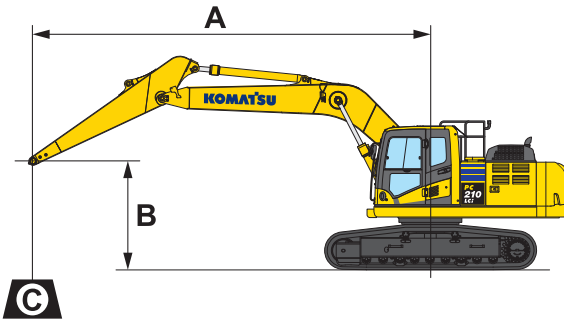

- A – Reach from swing center
- B – Bucket hook height
- C – Lifting capacities

Weights:

With 2,9 m arm: bucket linkage and bucket cylinder: 335 kg

With 600 mm shoes

- Rating over front
- Rating over side
- Rating at maximum reach

Arm length	A		7,5 m		6,0 m		4,5 m		3,0 m		1,5 m	
	B											

Arm length	7,5 m		6,0 m		4,5 m		3,0 m		1,5 m			
7,5 m	kg *3.820	*3.813			*5.020	*5.020						
6,0 m	kg *3.720	*3.720	*4.020	*4.020	*5.220	*5.220						
4,5 m	kg *3.720	*3.720	*5.520	4.370	*5.820	*5.820	*6.470	*6.470				
3,0 m	kg *3.870	3.563	*6.020	4.270	*6.820	5.770	*8.670	8.470	*12.520	*12.520		
1,5 m	kg *4.170	3.470	6.020	4.120	*7.870	5.470	*10.720	8.020	*7.770	*7.770		
0,0 m	kg *4.670	3.520	5.920	4.020	8.020	5.270	*11.720	7.620	*6.170	*6.170		
-1,5 m	kg 5.520	3.770	5.870	3.972	7.920	5.170	*11.870	7.520	*10.270	*10.270	*6.120	*6.120
-3,0 m	kg 6.420	4.270			7.920	5.170	*11.470	7.570	*15.770	14.270	*10.720	*10.720
-4,5 m	kg *7.620	5.670					*10.020	7.770	*13.870	*13.870		

* Load is limited by hydraulic capacity rather than tipping.

Ratings are based on SAE Standard No. J1097.

Rated loads do not exceed 87% of hydraulic lift capacity or 75% of tipping load.

When lifting with additional equipment installed to the arm, please subtract the weight of all additional equipment from the values stated.

Hydraulic Excavator

PC210LCi-10

Standard and Optional Equipment

ENGINE

Komatsu SAA6D107E-2 turbocharged common rail direct injection diesel engine	●
EU Stage IIIB compliant	●
Suction type cooling fan with radiator fly screen	●
Automatic engine warm-up system	●
Engine overheat prevention system	●
Fuel control dial	●
Auto-deceleration function	●
Engine key stop	●
Engine ignition can be password secured on request	●
Alternator 24 V/60 A	●
Starter motor 24 V/5,5 kW	●
Batteries 2 × 12 V/155 Ah	●

INTELLIGENT MACHINE CONTROL

Standard factory installed integrated 3D GNSS intelligent Machine Control system	●
Automatic bucket control	●
Topcon Sitelink ready	●

HYDRAULIC SYSTEM

Electronic closed-centre load sensing (E-CLSS) hydraulic system (HydrauMind)	●
Pump and engine mutual control (PEMC) system	●
One additional hydraulic circuit	●
6-working mode selection system; power mode, economy mode, breaker mode, attachment power and attachment economy mode, and lifting mode	●
PowerMax function	●
Adjustable PPC wrist control levers for arm, boom, bucket and swing, with sliding proportional control for attachments and 3 auxiliary buttons	●
Prepared for hydraulic quick-coupler	●
Additional hydraulic functions	○

UNDERCARRIAGE

Track roller guards	●
Track frame under-guards	●
600, 700, 800, 900 mm triple grouser shoes	○
Full length track roller guards	○

CABIN

Reinforced safety SpaceCab™; highly pressurised and tightly sealed hyper viscous mounted cab with tinted safety glass windows, large roof window with sun shade, pull-up type front window with locking device, removable lower window, front window wiper with intermittent feature, sun roller blind, cigarette lighter, ashtray, luggage shelf, floor mat	●
Heated, high back air suspension seat with lumbar support, console mounted height adjustable arm rests, and retractable seat belt	●
Automatic climate control system	●
12/24 Volt power supplies	●
Beverage holder and magazine rack	●
Hot and cool box	●
Radio	●
Auxiliary input (MP3 jack)	●
Lower wiper	○
Rain visor (not with OPG)	○

SERVICE AND MAINTENANCE

Automatic fuel line de-aeration	●
Double element type air cleaner with dust indicator and auto dust evacuator	●
KOMTRAX™ – Komatsu wireless monitoring system	●
Multi-function video compatible colour monitor with Equipment Management and Monitoring System (EMMS) and efficiency guidance	●
Toolkit	●
Komatsu CARE	●
Service points	○
Automatic greasing system	○

WORK EQUIPMENT

Mono boom	●
2,9 m arm	●
Bucket linkage with lifting eye	○
Komatsu buckets	○
Komatsu breakers	○

SAFETY EQUIPMENT

Rear view camera system	●
Electric horn	●
Overload warning device	●
Audible travel alarm	●
Boom safety valves	●
Large handrails, rear-view mirrors	●
Battery main switch	●
ROPS compliant to ISO 12117-2:2008	●
Emergency engine stop switch	●
Arm safety valve	●
OPG Level II front guard (FOPS), hinged type	○
OPG Level II top guard (FOPS)	○
Additional camera, right side mounted	○

DRIVES AND BRAKES

Hydrostatic, 3-speed travel system with automatic shift and planetary gear type final drives, and hydraulic travel and parking brakes	●
PPC control levers and pedals for steering and travel	●

LIGHTING SYSTEM

Working lights: 2 revolving frame, 1 boom (l.h.)	●
Additional working lights: 4 cab roof (front), 1 cab roof (rear), 1 boom (r.h.), 1 counterweight (rear), beacon	○

OTHER EQUIPMENT

Standard counterweight	●
Remote greasing for swing circle and pins	●
Electric refuelling pump with automatic shut-off function	●

Further equipment on request

- standard equipment
- optional equipment

Your Komatsu partner:

KOMATSU

Komatsu Europe International NV
 Mechelsesteenweg 586
 B-1800 VILVOORDE (BELGIUM)
 Tel. +32-2-255 24 11
 Fax +32-2-252 19 81
www.komatsu.eu

UENSS16701 12/2015

Materials and specifications are subject to change without notice.
KOMATSU is a trademark of Komatsu Ltd. Japan.