

KOMATSU

HD325-8

HD405-8

EU Stage IV Engine

OFF-HIGHWAY TRUCK



HD325/405

ENGINE POWER

386 kW / 518 HP @ 2.000 rpm

NOMINAL PAYLOAD

HD325-8: 36,5 metric tons
HD405-8: 40,0 metric tons

BODY CAPACITY, HEAPED

HD325-8: 24,0 m³
HD405-8: 27,3 m³

Walk-Around

HD325/405-8



ENGINE POWER

386 kW / 518 HP @ 2.000 rpm

NOMINAL PAYLOAD

HD325-8: 36,5 metric tons
HD405-8: 40,0 metric tons

BODY CAPACITY, HEAPED

HD325-8: 24,0 m³
HD405-8: 27,3 m³



PRODUCTIVITY ON DEMAND

Powerful and Environmentally Friendly

- EU Stage IV engine
- Eco-gauge and Eco guidance
- Adjustable auto idle shutdown

First-Class Comfort

- Newly designed spacious, economical cab
- Heated and ventilated air suspension seat
- High resolution LCD colour monitor
- Hydro-pneumatic suspension

Reliability & Maintenance

- Hydraulically driven, reversible cooling fan
- Fully hydraulic brake system
- High-rigidity frame
- Payload meter (PLM)
- Centralized greasing points
- Centralized arrangement of filters

Maximised Efficiency

- Hydraulically controlled wet multiple-disc brakes and retarder
- Auto Retard Speed Control (ARSC)
- K-ATOMiCS transmission with “Skip-Shift” function
- Komatsu Traction Control System (KTCS) (Option)

Safety First

- Komatsu SpaceCab™ – Built-in ROPS/FOPS
- Rear-view camera system
- Integrated stairways with handrails and gentle slope

KOMTRAX

- Komatsu Wireless Monitoring System
- 3G mobile communications
- Integrated communication antenna
- Increased operational data and fuel savings



A maintenance program for Komatsu customers

Powerful and Environmentally Friendly

High performance Komatsu engine

Powerful and fuel-efficient, the Komatsu SAA6D140E-7 engine on the HD325/405-8 delivers 386 kW at 2.000 rpm, approx. a 5% increase compared to previous models. The improved acceleration and shorter cycle times guarantee a higher productivity. Power train components were redesigned to accommodate the increased power.

Komatsu fuel-saving technology

The variable displacement piston pumps reduce loss of Power Take-Off (PTO). Improvements in hydraulic pressure for transmission control increase energy savings, and the sophisticated electronic control of the engine operation helps to achieve optimal energy efficiency.

Adjustable auto idle shutdown

To reduce unnecessary fuel consumption and exhaust emissions, and for lower operating costs, the Komatsu auto idle shutdown automatically turns off the engine after it idles for a set period of time, which can be easily programmed from 5 to 60 minutes. An Eco-gauge and Eco guidance tips on the cab monitor further encourage efficient operations.



Automatic Idling Setting System (AISS)

This system facilitates quick engine warm-up and operator cab cooling/warming. When the system is "ON", engine idle speed is kept at 1.100 rpm, and is lowered to 750 rpm as the coolant temperature rises. It automatically returns to 1.100 rpm when the coolant temperature drops.



Brake cooling oil recovery tank

A tank is installed on each rear wheel to capture brake cooling oil in the event of leakage from the floating seal.

HD325/405-8

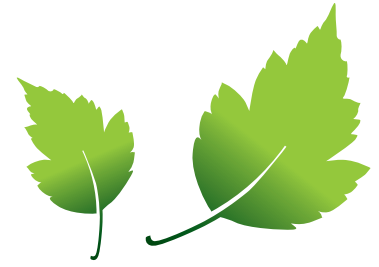
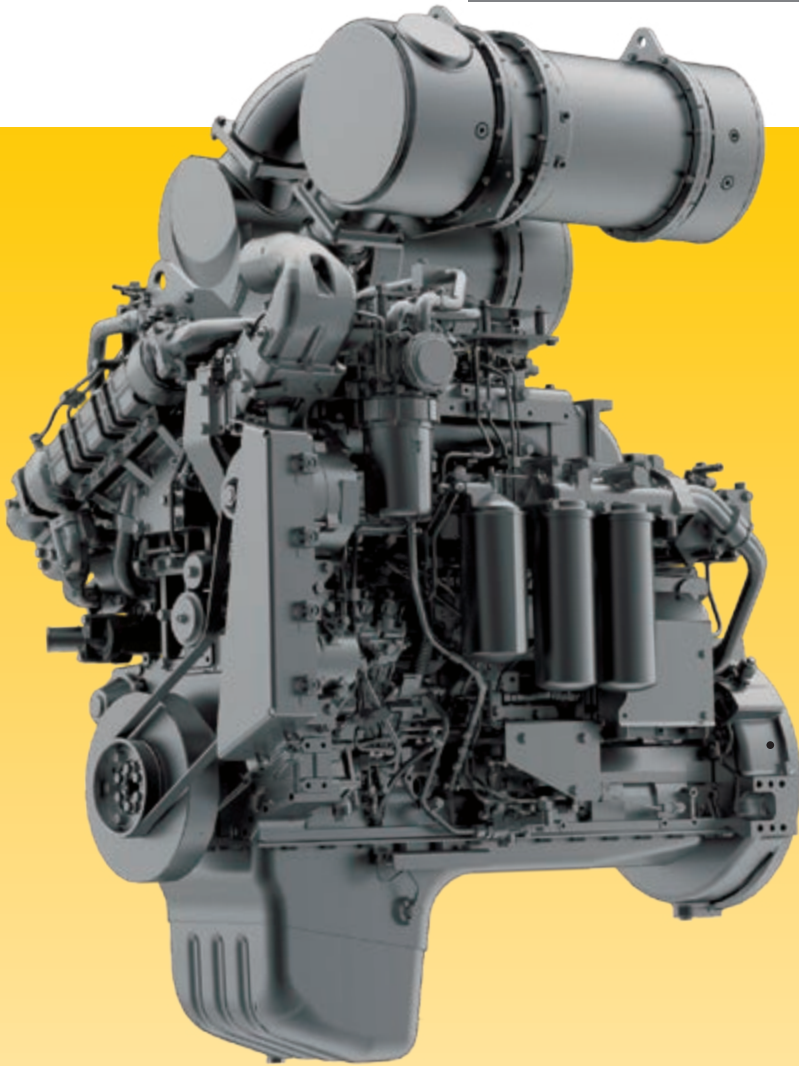

Komatsu EU Stage IV

The Komatsu EU Stage IV engine is productive, dependable and efficient. With ultra-low emissions, it provides a lesser environmental impact and a superior performance to help reduce operating costs and lets the operator work in complete peace of mind.

Heavy-duty aftertreatment

The aftertreatment system combines a Komatsu Diesel Particulate Filter (KDPF) and Selective Catalytic Reduction (SCR). The SCR system injects the correct amount of AdBlue® at the proper rate to break down NOx into water (H₂O) and nontoxic nitrogen gas (N₂). NOx emissions are reduced by 80% vs. EU Stage IIIB engines.

Exhaust Gas Recirculation (EGR)

Cooled EGR is a technology well-proven in current Komatsu engines. The increased capacity of the EGR cooler now ensures very low NOx emissions and a better engine performance.

Komatsu Closed Crankcase Ventilation (KCCV)

Crankcase emissions (blow-by gas) are passed through a CCV filter. The oil mist trapped in the filter is returned back to the crankcase while the filtered gas is returned to the air intake.

High-Pressure Common Rail (HPCR)

To achieve complete fuel burn and lower exhaust emissions, the heavy-duty High-Pressure Common Rail fuel injection system is computer controlled to deliver a precise quantity of pressurised fuel into the redesigned engine combustion chamber by multiple injections.

Variable Geometry Turbo (VGT)

The VGT provides optimal airflow to the engine combustion chamber under all speed and load conditions. Exhaust gas is cleaner, fuel economy is improved while machine power and performance are maintained.

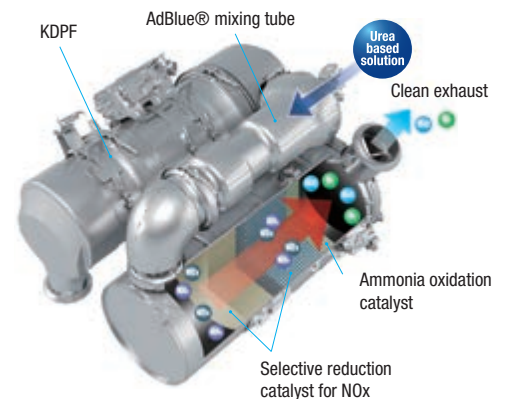

Adjustable idle shutdown



Eco-gauge and Eco guidance

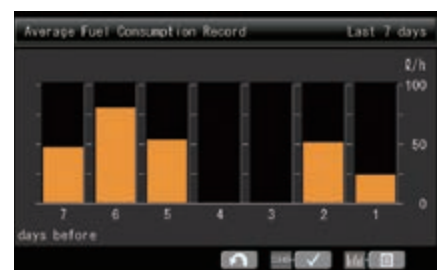

Fuel consumption history

Maximised Efficiency



Payload meter (PLM)

The PLM manages the payload of each hauling cycle and analyzes the truck's production volume and working conditions for a specific period. Loaded weight is displayed in real time, both on the cab's monitor and by external display lamps.



Komatsu Traction Control System (KTCS) (optional)

KTCS continuously monitors the rear wheels' rotating speed and vehicle speed for slippage. In case of excessive wheel slip, the brake is automatically applied, and optimum tire traction is maintained. KTCS activates and deactivates automatically, and improves productivity and tire life more than the conventional ASR system.



K-ATOMiCS transmission

K-ATOMiCS is an electronic shift control with automatic clutch modulation in all gears. It optimizes oil pressure for the clutch engagement and provides smoother shifting without torque off.

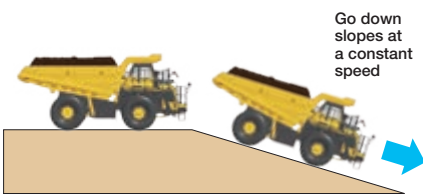

Auto Retard Speed Control (ARSC)

ARSC allows to easily set a constant downhill travel speed and lets the operator concentrate on steering. Speed can be adjusted appropriately to the slope grade at an increment of 1 km/h by clicking the control lever (± 5 km/h max.).

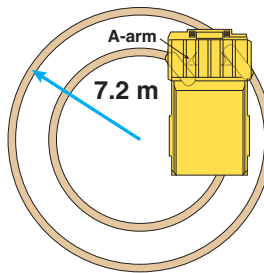

Small turning radius

The MacPherson strut type front suspension has a special A-frame between each wheel and the main frame. The wider space created between the front wheels and the main frame increases the turning angle of the wheels. The larger this turning angle, the smaller the turning radius of the truck.

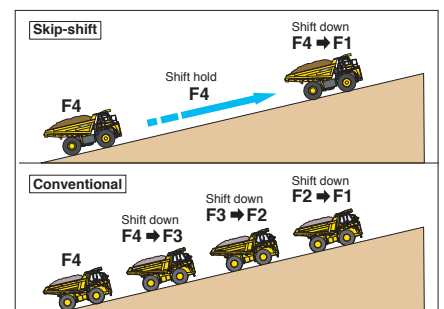

Skip shift function

Automatically selects a gear position depending on the slope grade when driving uphill, without shifting down through each gear. It reduces the number of downshifts, makes driving smoother, improves operator's comfort and reduces material spillage.

HD325/405-8



First-Class Comfort



Wide and comfortable cab

The wide Komatsu SpaceCab™ with user-friendly controls provides a comfortable and safe work environment. A fully adjustable air-suspended seat dampens vibrations and reduces the fatigue of long shifts. Large front and electric side windows give a superior visibility and increased confidence.

Hydro-pneumatic suspension

Komatsu's hydro-pneumatic suspension gives the HD325/405-8 a smooth ride with reduced pitching and excellent driving comfort. Less shocks for the operator and for the machine components also mean less spilled material and increased durability, comfort and productivity.

Low-noise design

To reduce noise levels, the cab is mounted on viscous dampeners. Further noise reduction is achieved by the integrated cab floor: it makes the cab air-tight and seals off the engine compartment. A low-noise and sound-insulated muffler helps to bring sound levels way down.



Set the steering wheel to the most comfortable position



The full size trainer seat is foldable and has a 2-point retractable seat belt.



Convenient auxiliary input (MP3 jack) and 12 V power supply

Heated & ventilated air-suspended seat

A high comfort air-suspended seat, with lumbar support and multiple adjustments, ensures operator well-being during the entire work shift. It can be heated and ventilated, for an easy start on cold winter days and a comfortable ride on hot summer days.



Information & Communication Technology



Lower operating costs

Komatsu ICT contributes to the reduction of operating costs by assisting to comfortably and efficiently manage operations. The monitor panel displays instant guidance messages to help promote energy saving, and the Eco-gauge indicates actual fuel consumption. To further improve savings, logs can be consulted for operations, Eco guidance and fuel consumption.

Large LCD colour monitor

A large user-friendly colour monitor enables safe, accurate and smooth work. Multilingual and with all essential information available at a glance, it features simple and easy-to-operate switches and multifunction keys that provide fingertip access to a wide range of functions and operating information.

Troubleshooting function

Various meters, gauges and warning functions are centrally arranged on the LCD unit. This unit facilitates the start-up inspection and promptly warns the operator with a lamp and buzzer if any abnormal conditions occur.



Information at a glance: basic dashboard LCD monitor



A multifunction monitor displays and controls a wealth of operational and maintenance information

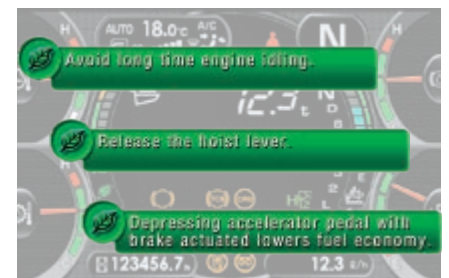

Eco guidance supports energy saving in real time

Tough and Reliable



High-rigidity frames

Cast-steel components are used in critical areas of the main frame where loads and shocks are most concentrated.



Body selection

Several different types of bodies are selectable, with optional equipment for various load conditions prepared for each one.

Robust dump body design

The standard dump body is made of high-tensile-strength steel for excellent rigidity and low maintenance cost. The V-shape and V-bottom design contribute to the structural strength. The side and bottom plates of the dump body are reinforced with lateral and longitudinal bolsters.

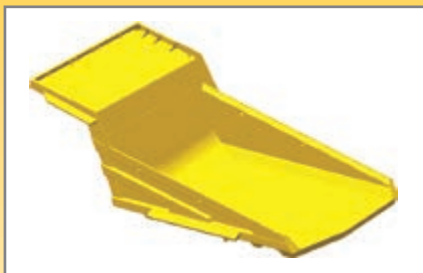

General purpose body

Designed for general purpose. Major portions of this body are made of abrasion-resistant steel plates to assure high durability.

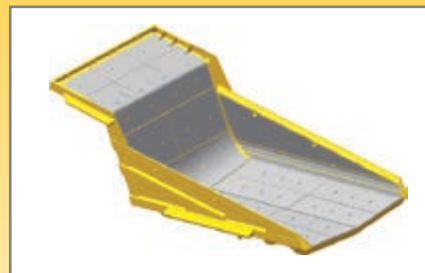

Body steel liners

Attaching liner plates is recommended if this body is carrying relatively large size rocks or highly abrasive material.

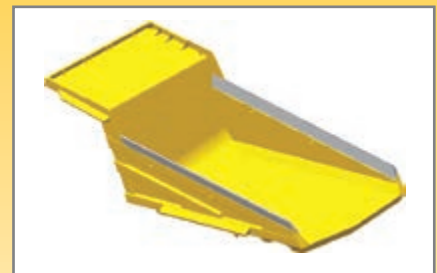

Side extension

Side extensions are for prevention of material spillage and for carrying low density material.

Safety First



ROPS/FOPS to ISO 3471 ROPS and ISO 3449 FOPS Level II standard



Safe cab access thanks to the low angle of the front stairways with handrails, slip-resistant



Rear-view camera system



Excellent all-round visibility

To keep the working area under control, a laminated-glass windshield, wide side windows, a standard rear-view camera and monitor, 3 additional under-view mirrors and 4 rear-view mirrors combine to minimise blind spots.

Supplementary steering and secondary brakes

Standard features on the HD325/405-8 include supplementary steering and secondary brakes. They help to guarantee safety in emergency situations.

Speed limiter

Maximum travel speed is limited independently for both empty and loaded conditions.

The optional overload speed limiter limits the maximum travel speed to 15 km/h when the payload exceeds the threshold value.

Antilock brake system (ABS) (optional)

This system prevents the tires from locking when using the service brake and the retarder, thus minimizing skidding under slippery conditions.

Secondary engine shutdown switch

Located in the cab for emergency use.





Easy Maintenance



Ground access battery box and battery disconnect switch

For easy and safe daily check and service work, the battery box and battery disconnect switch are both accessible from ground level.

Centralized greasing points

Greasing points are located accessible from ground level to make daily maintenance easier.

Long service intervals

Engine oil at 500 hours, transmission oil at 1.000 hours and hydraulic oil at 4.000 hours change intervals minimize operating cost.

Komatsu CARE™

Komatsu CARE™ is a maintenance program that comes as



standard with your new Komatsu machine. It covers factory-scheduled maintenance, performed with Komatsu Genuine parts by Komatsu-trained technicians. Depending on your machine's engine, it also offers extended coverage of the Komatsu Diesel Particulate Filter (KDPF) or the Komatsu Diesel Oxidation Catalyst (KDOC), and of the Selective Catalytic Reduction (SCR). Please contact your local Komatsu distributor for terms and conditions.

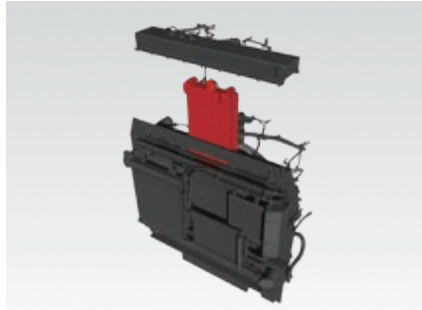

Modular design wide core radiator with reversible fan

The wide core modular radiator prevents clogging even in a dusty work environment. To minimize manual cleaning, a reversible fan blows the dust out. The radiator core can be removed without the entire assembly, keeping repair costs down.



Centralized arrangement of filters

The filters are centralized so that they can be serviced easily.



Maintenance caution



Basic maintenance screen



Radiator fan mode



Troubleshooting screen



HD325/405-8

KOMTRAX

The way to higher productivity

KOMTRAX uses the latest wireless monitoring technology. Compatible on PC, smartphone or tablet, it delivers insightful and cost saving information about your fleet and equipment, and offers a wealth of information to facilitate peak machine performance. By creating a tightly integrated web of support it allows proactive and preventive maintenance and helps to efficiently run a business.



Knowledge

You get quick answers to basic and critical questions about your machines – what they're doing, when they did it, where they're located, how they can be used more efficiently, and when they need to be serviced.

Performance data is relayed by wireless communication technology (Satellite, GPRS or 3G depending on model) from the machine to a computer and to the local Komatsu distributor – who's readily available for expert analysis and feedback.

Power

The detailed information that KOMTRAX puts at your fingertips 24 hours a day, 7 days a week gives the power to make better daily and long-term strategic decisions – at no extra cost. Problems can be anticipated, maintenance schedules customised, downtime minimised and machines kept where they belong: working on the jobsite.

Convenience

KOMTRAX enables convenient fleet management on the web, wherever you are. Data is analysed and packaged specifically for effortless and intuitive viewing in maps, lists, graphs and charts. You can foresee eventual maintenance issues and required spare parts, and troubleshoot a problem before Komatsu technicians arrive on site.



Specifications HD325-8

ENGINE

Model	Komatsu SAA6D140E-7
Type	Common rail direct injection, water-cooled, turbocharged, after-cooled, cooled EGR diesel
Engine power	
at rated engine speed	2.000 rpm
ISO 14396	386 kW / 518 HP
ISO 9249 (net engine power)	383 kW / 514 HP
No. of cylinders	6
Bore × stroke	140 × 165 mm
Displacement	15,24 l
Max. torque	3.644 Nm (372 kgf-m)
Governor	Electronically controlled
Lubrication system	
Lubrication method	Gear pump, force lubrication
Filter	Full-flow filter
Air-filter type	Dry type with double elements, precleaner and evacuator valve

TRANSMISSION

Torque converter	3-element, 1-stage, 2-phase
Transmission	Full-automatic, planetary type
Speed range	7 speeds forward and 1 reverse
Lock-up clutch	Wet, multiple-disc clutch
Forward	Torque converter drive in 1st gear, direct drive in 1st lock-up and all higher gears
Reverse	Torque converter drive
Shift control	Electronic shift control with automatic clutch modulation in all gears
Max. travel speed	68 km/h

STEERING SYSTEM

Type	Full-hydraulic power steering with two double-acting cylinders
Supplementary steering	Automatically and manually controlled (meets ISO 5010 and SAE J1511)
Minimum turning radius, centre of front tyre	7,2 m
Max. steering angle, outside tyre	43°

SUSPENSION

MacPherson strut type front suspension and four-link type rear axle suspension with independent, hydropneumatic cylinders.	
Effective cylinder stroke	
Front suspension	250 mm
Rear suspension	129 mm
Rear axle oscillation	
Oil stopper	6,9°
Mechanical stopper	7,7°

TYRES

Standard tyres	18.00 R33
----------------	-----------

CAB

Complies with ISO 3471 ROPS (Roll-Over Protective Structure) and ISO 3449 level II FOPS (Falling Object Protection Structure) standards.

AXLES

Final drive type	Planetary gear
Rear axle	Full-floating
Ratios	
Differential	3,125
Planetary	4,737

BRAKES

Brakes meet ISO 3450 standard.	
Service brakes	
Front	Full-hydraulic control, caliper disc type
Rear	Full-hydraulic control, oil-cooled multiple-disc type
Parking brake	Spring applied, multiple-disc type
Retarder	Oil-cooled, multiple-disc rear brakes act as retarder
Retarder capacity (continuous)	689 kW / 924 HP
Secondary brake	Manual pedal operation. When hydraulic pressure drops below the specified level, parking brake is automatically actuated.
Brake surface	
Front	968 cm ²
Rear	50.847 cm ²

MAIN FRAME

Type	Box-sectioned structure
------	-------------------------

SERVICE REFILL CAPACITIES

Fuel tank	456 l
AdBlue® tank	34,7
Engine oil	50 l
Torque converter, transmission and retarder cooling	112 l
Differentials (total)	45 l
Final drives (total)	30 l
Hydraulic system	120 l
Suspension (total)	44,2 l

HYDRAULIC SYSTEM

Hoist cylinder	Twin, 2-stage telescopic type
Relief pressure	20,6 MPa (210 kg/cm ²)
Hoist time (at high idle)	10 s

ENVIRONMENT

Engine emissions	Fully complies with EU Stage IV exhaust emission regulations
Noise level, LpA operator ear	78 dB(A) (ISO 6396 dynamic test)
Vibration levels (EN 12096:1997)	
Hand/arm	≤ 2,5 m/s ² (uncertainty K = 0,99 m/s ²)
Body	≤ 0,5 m/s ² (uncertainty K = 0,28 m/s ²)
Contains fluorinated greenhouse gas HFC-134a (GWP 1430). Quantity of gas 1,2 kg, CO ₂ equivalent 1,72 t	

Dimensions & Performance Figures

WEIGHT (APPROX.)

Empty weight	34.180 kg
Gross vehicle weight	70.760 kg
Weight distribution	
Empty	
Front axle	56,5%
Rear axle	43,5%
Loaded	
Front axle	33,7%
Rear axle	66,3%

BODY

Capacity	
Struck	16,9 m ³
Heaped (2:1, SAE)	24,0 m ³
Payload	36,5 metric tons
Material	130 kg/mm ² high tensile strength steel
Material thickness	
Bottom	16 mm
Front	12 mm
Sides	9 mm
Target area (inside length x width)	5.515 mm x 3.380 mm
Heating	Exhaust heating

TRAVEL PERFORMANCE

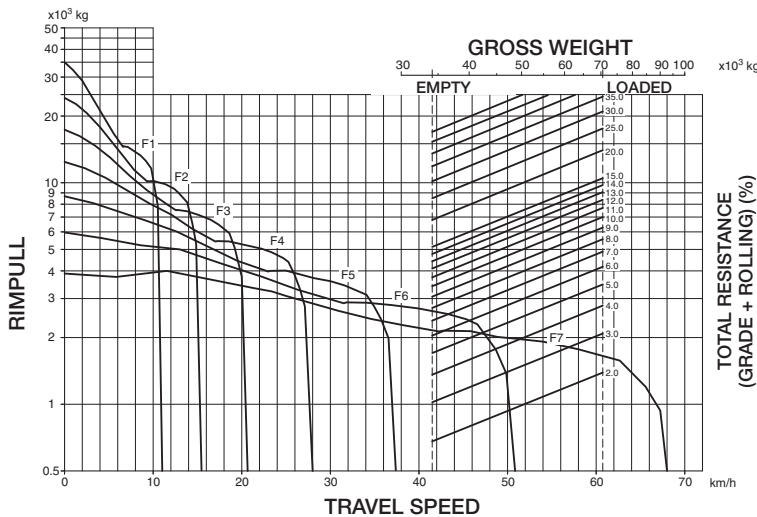

BRAKE PERFORMANCE

GRADE DISTANCE: CONTINUOUS DESCENT

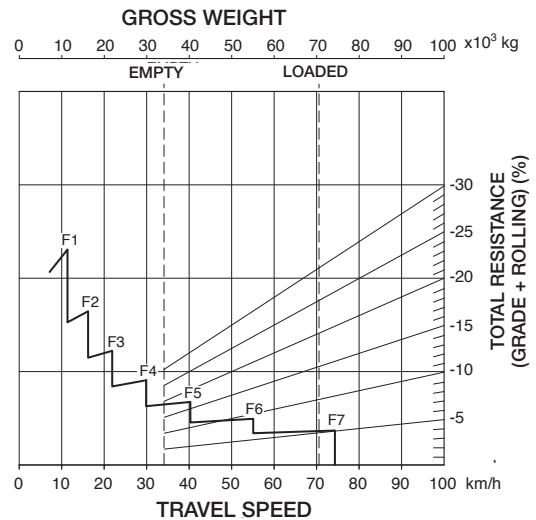

At ambient temperature 40°C. Retarder performance varies depending on ambient temperature.

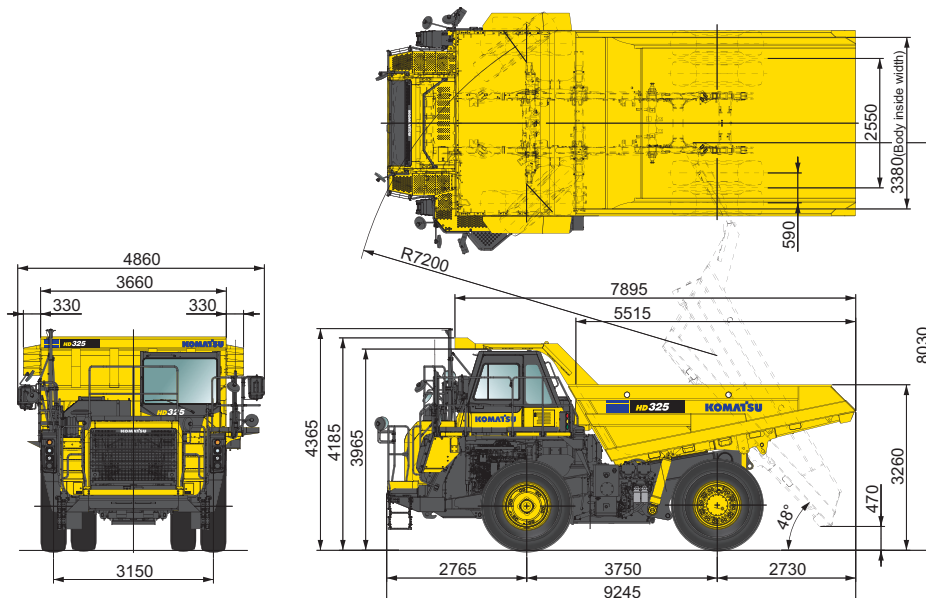

Specifications HD405-8

ENGINE

Model	Komatsu SAA6D140E-7
Type	Common rail direct injection, water-cooled, turbocharged, after-cooled, cooled EGR diesel
Engine power	
at rated engine speed	2.000 rpm
ISO 14396	386 kW / 518 HP
ISO 9249 (net engine power)	383 kW / 514 HP
No. of cylinders	6
Bore × stroke	140 × 165 mm
Displacement	15,24 l
Max. torque	3.644 Nm (372 kgf-m)
Governor	Electronically controlled
Lubrication system	
Lubrication method	Gear pump, force lubrication
Filter	Full-flow filter
Air-filter type	Dry type with double elements, precleaner and evacuator valve

TRANSMISSION

Torque converter	3-element, 1-stage, 2-phase
Transmission	Full-automatic, planetary type
Speed range	7 speeds forward and 1 reverse
Lock-up clutch	Wet, multiple-disc clutch
Forward	Torque converter drive in 1st gear, direct drive in 1st lock-up and all higher gears
Reverse	Torque converter drive
Shift control	Electronic shift control with automatic clutch modulation in all gears
Max. travel speed	66 km/h

STEERING SYSTEM

Type	Full-hydraulic power steering with two double-acting cylinders
Supplementary steering	Automatically and manually controlled (meets ISO 5010 and SAE J1511)
Minimum turning radius, centre of front tyre	7,9 m
Max. steering angle, outside tyre	38°

SUSPENSION

MacPherson strut type front suspension and four-link type rear axle suspension with independent, hydropneumatic cylinders.	
Effective cylinder stroke	
Front suspension	250 mm
Rear suspension	129 mm
Rear axle oscillation	
Oil stopper	6,9°
Mechanical stopper	7,7°

TYRES

Standard tyres	21.00 R33
----------------	-----------

CAB

Complies with ISO 3471 ROPS (Roll-Over Protective Structure) and ISO 3449 level II FOPS (Falling Object Protection Structure) standards.

AXLES

Final drive type	Planetary gear
Rear axle	Full-floating
Ratios	
Differential	3,125
Planetary	5,211

BRAKES

Brakes meet ISO 3450 standard.	
Service brakes	
Front	Full-hydraulic control, caliper disc type
Rear	Full-hydraulic control, oil-cooled multiple-disc type
Parking brake	Spring applied, multiple-disc type
Retarder	Oil-cooled, multiple-disc rear brakes act as retarder
Retarder capacity (continuous)	689 kW / 924 HP
Secondary brake	Manual pedal operation. When hydraulic pressure drops below the specified level, parking brake is automatically actuated.
Brake surface	
Front	968 cm ²
Rear	50.847 cm ²

MAIN FRAME

Type	Box-sectioned structure
------	-------------------------

SERVICE REFILL CAPACITIES

Fuel tank	456 l
AdBlue® tank	34,7
Engine oil	50 l
Torque converter, transmission and retarder cooling	112 l
Differentials (total)	45 l
Final drives (total)	30 l
Hydraulic system	120 l
Suspension (total)	44,2 l

HYDRAULIC SYSTEM

Hoist cylinder	Twin, 2-stage telescopic type
Relief pressure	20,6 MPa (210 kg/cm ²)
Hoist time (at high idle)	10 s

ENVIRONMENT

Engine emissions	Fully complies with EU Stage IV exhaust emission regulations
Noise level, LpA operator ear	78 dB(A) (2000/14/EC Stage II)
Vibration levels (EN 12096:1997)	
Hand/arm	≤ 2,5 m/s ² (uncertainty K = 1,17 m/s ²)
Body	≤ 0,5 m/s ² (uncertainty K = 0,26 m/s ²)
Contains fluorinated greenhouse gas HFC-134a (GWP 1430). Quantity of gas 1,2 kg, CO ₂ equivalent 1,72 t	

Dimensions & Performance Figures

WEIGHT (APPROX.)

Empty weight	37.335 kg
Gross vehicle weight	77.415 kg
Weight distribution	
Empty	
Front axle	54,2%
Rear axle	45,8%
Loaded	
Front axle	32,9%
Rear axle	67,1%

BODY

Capacity	
Struck	20,0 m ³
Heaped (2:1, SAE)	27,3 m ³
Payload	40 metric tons
Material	130 kg/mm ² high tensile strength steel
Material thickness	
Bottom	25 mm
Front	16 mm
Sides	14 mm
Target area (inside length x width)	5.640 mm x 3.380 mm
Heating	Exhaust heating

TRAVEL PERFORMANCE

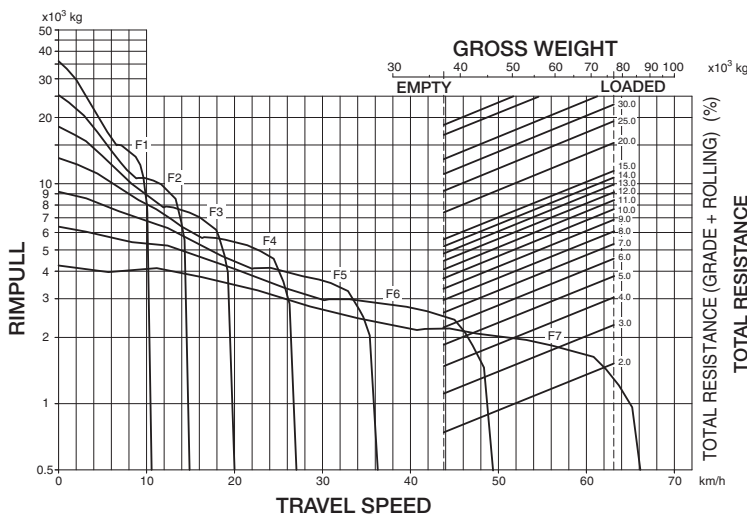

BRAKE PERFORMANCE

GRADE DISTANCE: CONTINUOUS DESCENT

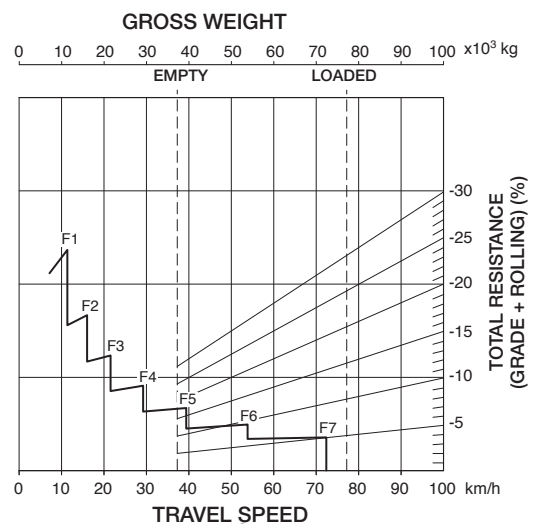

At ambient temperature 40°C. Retarder performance varies depending on ambient temperature.

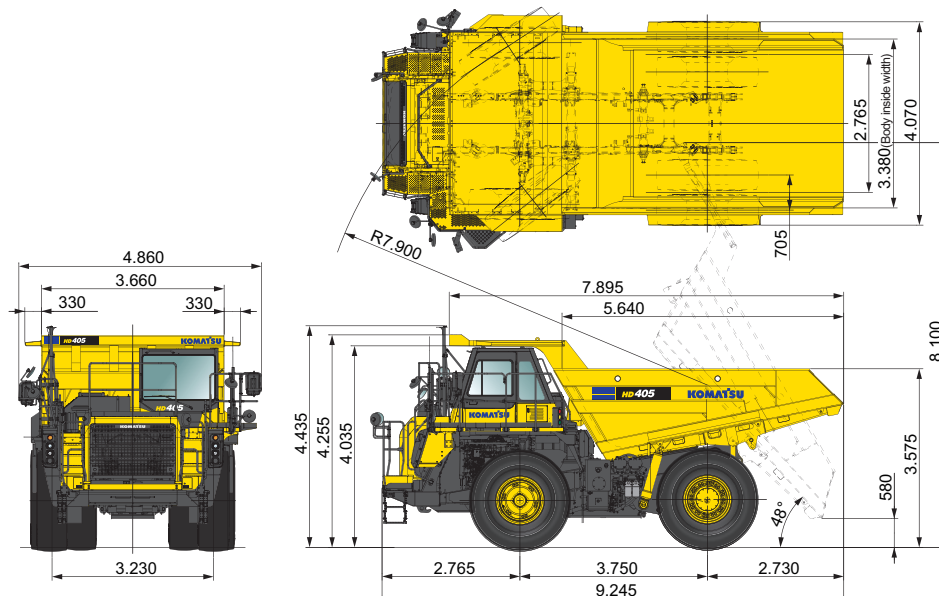

Standard and Optional Equipment

ENGINE

Komatsu SAA6D140E-7 turbocharged common rail direct injection diesel engine EU Stage IV compliant	●
Remote hydraulically driven, variable speed, reversible cooling fan	●
Auto-deceleration function	●
Adjustable auto idle shutdown	●
Alternator 90 A / 24 V	●
Starter motor 1 × 11 kW	●
Batteries 2 × 12 V	●
Dry type air cleaner, double element with dust indicator	●

BODY

Body exhaust heating kit	●
Spill guard, 300 mm, weld-on/bolt-on type	●
Electronic hoist control system	●
Rock ejector bars	●
Safety pin	●
Tire guard, rear, weld-on type	●
Cab guard, left, bolt-on type	●
Platform guard, bolt-on type	●
Steel body liners	○
Side extensions	○

OTHER EQUIPMENT

Mud guards	●
Engine underguard	●
Propeller shaft guards, front and rear	●
Transmission underguard	●
Komatsu Diesel Particulate Filter (KDPF) thermal guard	●
Fire prevention covers	●
Auto Retard Speed Control (ARSC)	●
Payload meter (PLM)	●
Engine side covers	●
Lockable fuel cap and covers	●
Brake cooling oil recovery tank	●
Electric circuit breakers, 24 V	●
Full automatic transmission with lock-up clutch	●
Modular core radiator system	●
Engine coolant and oilpan heaters	○

CABIN

ROPS/FOPS cab, sound suppression type with tinted windows, front laminated glass, two doors (left and right)	●
Operator seat, air suspension type with heating, ventilation and retractable 3-point seat belt	●
Trainer seat with 2-point seat belt	●
Steering wheel, tilt and telescopic	●
Air conditioner	●
Sun visor	●
Windshield washer and wiper (with intermittent feature)	●
Cigarette lighter, ashtray, cup holder, space for lunch box	●
AM/FM radio with auxiliary input (MP3 jack)	●
Body dump counter	●
Eco-gauge and Eco guidance	●
2 × 12 Volt power supply	●

SERVICE AND MAINTENANCE

Automatic greasing system	●
Large LCD colour monitor panel	●
KOMTRAX – Komatsu wireless monitoring system	●
Komatsu CARE™ – a maintenance program for Komatsu customers	●
Electric refuelling pump	●
Fuel tank with fast fill coupler	●
Centralised greasing points (4)	○
Battery jump start	○
Hydraulic oil filter clogging alarm	○
PM service connections	○
Radiator shutter, canvas type	○
Centralized quick connectors for oil change	○
Wheel chocks	○

AXLES AND TYRES

Hydropneumatic suspension (front and rear)	●
Komatsu Traction Control System	○
Automatic suspension, 3-mode	○

SAFETY EQUIPMENT

Speed limiter	●
Back-up alarm	●
Automatic supplementary steering	●
Coolant temperature alarm and light	●
Battery main switch	●
Hand rails for platform	●
Horn, electric	●
Ladders, left and right hand side	●
Front brake cut-off system	●
Protective fence around engine hood	●
Heated rear-view mirrors	●
Under-view mirrors	●
Rear-view camera system	●
Secondary engine shutdown switch (inside cab)	●
Hydraulically controlled wet multiple-disc brakes and retarder	●
Overrun warning and prevention system	●
Overturn warning system	●
Pedal-operated secondary brake	●
Neutral coast inhibitor	●
Emergency engine stop switch	●
Step light	●
Overload speed limiter	○
Antilock brake system (ABS)	○
Starter disconnect switch	○
Body position alarm	○

LIGHTING SYSTEM

Back-up light	●
Halogene headlights high and low beam	●
Side lamps, left and right	●
Fog lights	●
LED stop and tail lights, turn indicator lights with hazard function	●
Back work lights, left and right side	○
Additional back-up light	○

Further equipment on request

- standard equipment
- optional equipment

Your Komatsu partner:

KOMATSU

**Komatsu Europe
International N.V.**

Mechelsesteenweg 586
B-1800 VILVOORDE (BELGIUM)
Tel. +32-2-255 24 11
Fax +32-2-252 19 81
www.komatsu.eu

EENSS20350 08/2017

KOMATSU is a trademark of Komatsu Ltd. Japan.