

KOMATSU

PW148-11

EU Stage IV Engine

HYDRAULIC WHEELED EXCAVATOR



PW148

ENGINE POWER

90 kW / 121 HP @ 2.100 rpm

OPERATING WEIGHT

14.200 - 17.160 kg

BUCKET CAPACITY

max. 0,86 m³

Walk-Around

PW148-11



ENGINE POWER

90 kW / 121 HP @ 2.100 rpm

OPERATING WEIGHT

14.200 - 17.160 kg

BUCKET CAPACITY

max. 0,86 m³



EXCEPTIONAL WORKABILITY AND ENVIRONMENTAL PERFORMANCE

Powerful and environmentally friendly

- EU Stage IV engine
- Adjustable idle shutdown
- Komatsu fuel-saving technology
- Excellent travel performance
- High lifting capacity

Total versatility

- Compact design with short tail swing radius
- Ideal for a wide range of applications
- Additional hydraulic circuit
- Komatsu Integrated Attachment Control (KIAC) (option)
- A wide choice of options

First-class operator comfort

- Premium air-suspended operator seat with integrated joystick consoles (option)
- Boom suspension system (ECSS) (option)
- KomVision surround view system
- Improved widescreen monitor
- Optional joystick steering system

State-of-the-art controls

- Proportional controls for attachments
- Improved, ergonomic switches
- 6 working modes

Easy maintenance

- Improved service access
- Extended undercarriage maintenance interval
- Centralised greasing system
- User-friendly location of the electric refuelling pump
- Simple access to the AdBlue® tank

KOMTRAX

- Komatsu Wireless Monitoring System
- 3G mobile communications
- Increased operational data and fuel savings
- Integrated communication antenna



A maintenance program
for Komatsu customers

Powerful and Environmentally Friendly



Higher productivity

Along with its compact size, the PW148-11 features an unrivalled lifting performance. The combination of power, weight distribution, convenient dimensions and complete control makes it the top choice for heavy-duty lifting applications, simple excavating tasks in narrow alleys, and for road and sewer construction sites.

Komatsu fuel-saving technology

Fuel consumption on the PW148-11 is lower by up to 13%. Engine management is enhanced. The variable speed matching of the engine and hydraulic pumps guarantee efficiency and precision during single and combined movements. A viscous clutch enables variable cooling fan speed to further reduce fuel consumption.

Adjustable idle shutdown

The Komatsu auto idle shutdown automatically turns off the engine after it idles for a set period of time. This feature can easily be programmed from 5 to 60 minutes, to reduce unnecessary fuel consumption and exhaust emissions, and to lower operating costs. An Eco-gauge and the Eco guidance tips on the cab monitor further encourage efficient operations.

PW148-11

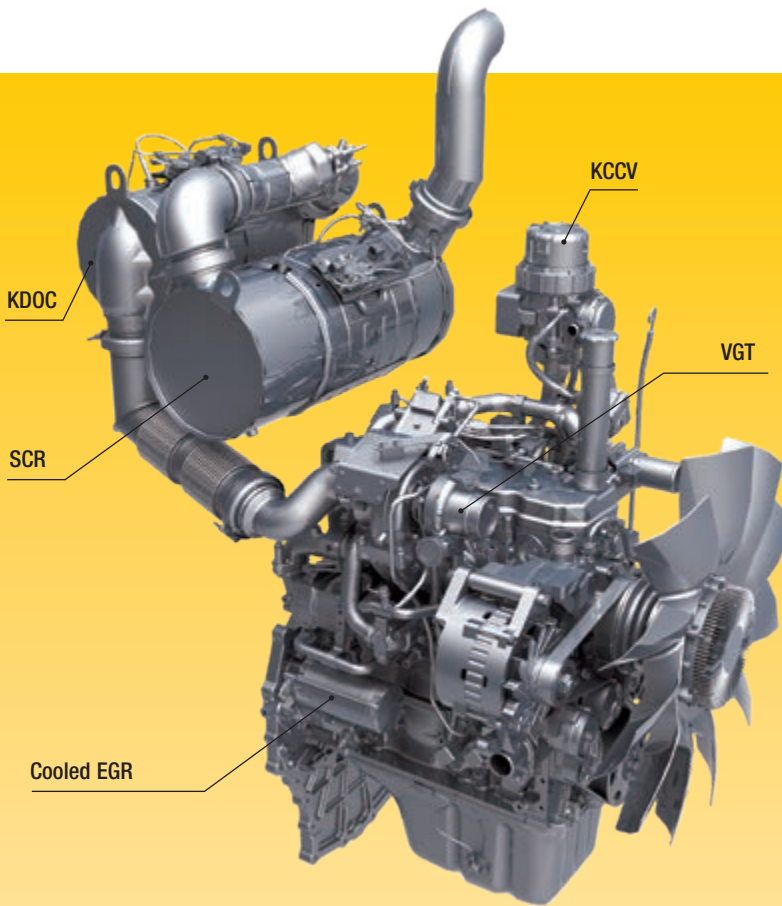
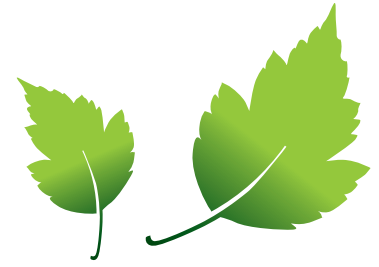

Komatsu EU Stage IV

The Komatsu EU Stage IV engine is productive, dependable and efficient. With ultra-low emissions, it provides a lower environmental impact and a superior performance to help reduce operating costs and lets the operator work in complete peace of mind.

Heavy-duty aftertreatment

The aftertreatment system combines a Komatsu Diesel Oxidation Catalyst (KDOc) and Selective Catalytic Reduction (SCR). The SCR injects the correct amount of AdBlue® into the system at the proper rate to break down NOx into water (H₂O) and non-toxic nitrogen gas (N₂).

Exhaust Gas Recirculation (EGR)

Cooled EGR is a technology well-proven in current Komatsu engines. The increased capacity of the EGR cooler now ensures very low NOx emissions and a better engine performance.

Komatsu Closed Crankcase Ventilation (KCCV)

Crankcase emissions (blow-by gas) are passed through a CCV filter. The oil mist trapped in the filter is returned back to the crankcase while the filtered gas is returned to the air intake.

High-Pressure Common Rail (HPCR)

To achieve complete fuel burn and lower exhaust emissions, the heavy-duty High-Pressure Common Rail fuel injection system is computer controlled to deliver a precise quantity of pressurised fuel into the redesigned engine combustion chamber by multiple injections.

Variable Geometry Turbo (VGT)

The VGT provides optimal airflow to the engine combustion chamber under all speed and load conditions. Exhaust gas is cleaner, fuel economy is improved while machine power and performance are maintained.

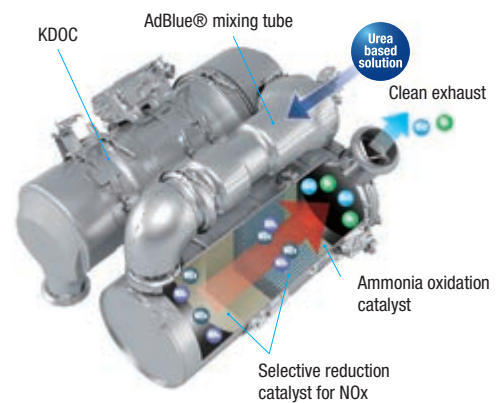

Eco-gauge, Eco guidance and fuel consumption gauge

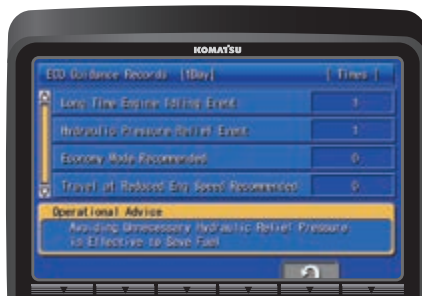

ECO guidance record

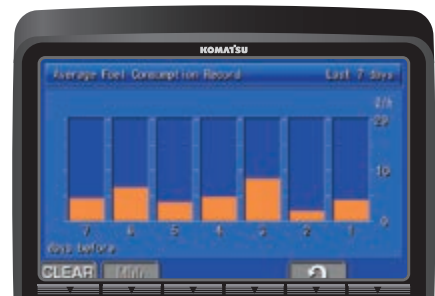

Fuel consumption history

Total Versatility

Compact design

The PW148-11 is perfect for confined work sites, with a compact design and a tail swing radius of only 1,85 m. In urbanised areas, but also on road or sewer construction sites where space is limited, the PW148-11 is a high output performer and offers more safety and less worries for the operator.

Additional hydraulic circuit

To allow the use of many attachments, such as buckets, breakers or clamshell buckets, an additional hydraulic circuit controlled by a sliding joystick button is standard on the PW148-11. To further increase versatility and flexibility, a second optional auxiliary circuit and an optional hydraulic quick-coupler actuation are also available. In combination with the Komatsu Integrated Attachment Control (KIAC), changing and operating different attachments becomes child's play.

Trailer hitch

For increased versatility, the PW148-11 can be equipped with either a car ball type hitch, an agricultural ball type hitch, or a truck type automatic hitch, for trailers up to 7,5 tonnes with an overrun brake. All necessary electric and hydraulic hook-ups are provided, including two auxiliary undercarriage circuits for dumping or tail-gate operation. These trailer functions can be operated from the cab joysticks.



Different trailer hitches are available

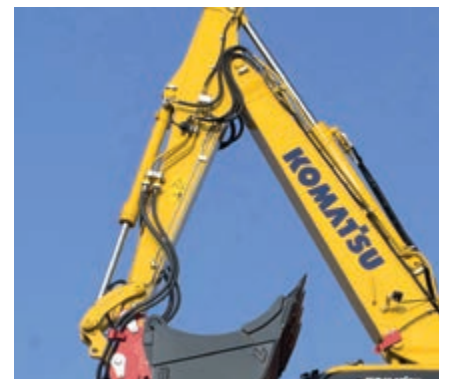

New HCU piping layout with a unified design for all arm lengths

PW148-11



Lehnhoff quick-couplers – mechanical, hydraulic or fully hydraulic – are now available for factory installation. They can turn an excavator into a multi-functional tool carrier for any type of attachment. All quick-couplers offer high functional safety thanks to their sealed locking mechanisms and hydraulics. Load hooks are standard on all models. Customers benefit from Komatsu quality optimized piping layout and hose routing and from a 24 months factory warranty.



Mechanical quick-coupler MS10
Durable and reliable even in heavy-duty operations. Locked by turning a socket wrench, safely locked over dead point.



Fully hydraulic quick-coupler Variolock VL100
The operator can comfortably change attachments including hydraulic connections from the cab in a matter of seconds, without having to leave the cab and without depending on other personnel. Leads to increased productivity and encourages the operator to use the right tool for the job. It also helps to prevent hose ruptures and contamination of the hydraulic system and of the environment.



Hydraulic quick-coupler HS10
Convenient, quick and safe locking from driver's cab. Locked hydraulically by a double-acting cylinder.

First-Class Comfort



Increased comfort

The SpaceCab™ provides an ergonomic and quiet work environment, with an outstanding view of the jobsite. ROPS certified, it was specifically designed by Komatsu for hydraulic excavators, with a reinforced pipe-structured framework set up on viscous damper mounts for low vibration levels. The standard telescopic steering wheel is comfortably adjustable in height and reach.

Low-noise design

Komatsu wheeled excavators have very low external noise levels and are especially well-suited for work in confined spaces or urban areas. The optimal usage of sound insulation and of sound absorbing materials helps to make noise levels inside the cab comparable to those of an executive car.

Premium comfort seat (option)

The premium comfort seat comes with suspended joystick consoles, top quality cushioning, auto weight adjustment, pneumatic lumbar support and a climate control system for perfect seat temperature adjustment.

Improved operator convenience

With increased in-cab storage space, an auxiliary input (MP3 jack) and 12 V and 24 V power supply, the cab offers maximum convenience. The automatic air conditioner allows the operator to easily and precisely set the cab's atmosphere.

Boom suspension system (ECSS) (option)

A boom suspension system (ECSS) provides a significant increase in comfort when travelling over bumps.



New premium comfort seat



Boom suspension system (ECSS) for increased travel comfort

PW148-11

State-of-the-Art Controls

Easy operation

The Komatsu PW148-11 features an operational concept that puts full control of the machine right at the operator's fingertips. Different camera views, undercarriage attachments and the manual axle lock can all be actuated by buttons on top of the operational levers. Without removing the hand from the joystick, the operator can switch from boom operation to undercarriage control for complete and precise control over the parallel dozer blade.

Proportional controls

The ergonomic joysticks with proportional controls were specially redesigned and developed for working with a wheeled excavator. They have horizontal sliders for the first and second (optional) hydraulic circuits and offer safe and precise operation of attachments such as ditch cleaning buckets, sorting grapples, clamshell buckets, tilt rotators and of many other hydraulic attachments that require very fine control.

Komatsu Integrated Attachment Control (KIAC) (option)

For fast and safe tool changes without leaving the cab, the settings for oil flow and pressure of up to 15 hydraulic attachments are available as presets directly on the monitor panel. Komatsu Integrated Attachment Control (KIAC) includes adjustments for the first and second (optional) hydraulic circuits. Selecting the breaker mode automatically cuts all pressure in the return line.

6 working modes

The PW148-11 delivers the required power with the lowest fuel consumption. 6 working modes are available: Power, Lifting/Fine Operation, Breaker, Economy, Attachment Power and Attachment Economy. The operator can ideally balance the Economy mode between power and economy to match the work at hand.



Komatsu Integrated Attachment Control (KIAC)



Adjustable oil flow



Ergonomically designed switches that light up for safe and easy night operation



For frequent steering, the Adjustable Joystick Steering option allows to control the machine with less effort

Information & Communication Technology



Lower operating costs

Komatsu ICT contributes to the reduction of operating costs by assisting to comfortably and efficiently manage operations. It raises the level of customer satisfaction and the competitive edge of our products.

Widescreen monitor

Installed with a choice of 24 languages, the widescreen monitor with simple switches and multifunction keys gives fingertip access to a large range of functions and operating info.

An evolutionary interface

Helpful information is now easier than ever to find and understand with the upgraded monitor interface. An optimal main screen for the ongoing work can be selected simply by pressing the F6 key.

Operation Records (1Day)	
Working Hours (Energy DO)	0.2 h
Average Fuel Consumption	7.2 l/h
Actual Working Hours	0.1 h
Ave Fuel Consumption (Actual Working)	7.2 l/h
Fuel Consumption	7 l
Idling Hours	0.1 h

Quick view on the operation logs



With KomVision, various camera view options help to maintain a constant bird's eye view from above the machine

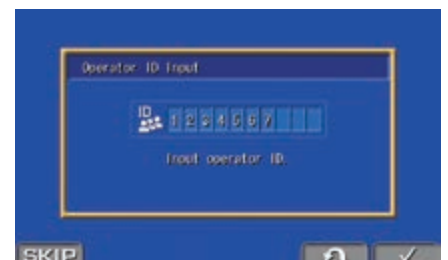

Operator identification function

Safety First



Optimal jobsite safety

Safety features on the Komatsu PW148-11 comply with the latest industry standards and work in synergy to minimise risks to people in and around the machine. A neutral detection system for travel and work equipment levers increase jobsite safety, along with a seat belt caution indicator and an audible travel alarm. Highly durable anti-slip plates – with additional high friction covering – maintain long term traction performance.



KomVision cameras



Short tail swing radius



Handrails and anti-slip plates

KomVision

With a series of high definition networked cameras fitted on the machine, KomVision provides a crystal clear, real-time bird's eye view of the immediate surroundings on the wide-screen cab monitor. The operator can quickly and easily check the machine's vicinity prior to making any movement, and focus on the work at hand even in low light conditions.

Safe operation in confined areas

The compact tail design minimises the risks of rear impact and lets the operator concentrate fully on the job. The machine can work safely in narrow spaces or in obstructed areas.

Safe maintenance

Thermal guards around high temperature areas of the engine, protected fan belt and pulleys, a pump/engine partition that prevents hydraulic oil from spraying onto the engine, and exceptionally sturdy handrails: in Komatsu tradition, the highest safety level is provided for a fast and smooth maintenance.

Easy Maintenance



Simple and convenient service

The large doors and engine hood give convenient access to all daily service points. Filters are centralised and required service intervals are longer to keep machine downtime to a minimum.

Komatsu CARE™

Komatsu CARE™ is a maintenance program that comes as standard with your new Komatsu machine. It covers factory-scheduled maintenance, performed with Komatsu Genuine parts by Komatsu-trained technicians. Depending on your machine's engine, it also offers extended coverage of the Komatsu Diesel Particulate Filter (KDPF) or the Komatsu Diesel Oxidation Catalyst (KDOC), and of the Selective Catalytic Reduction (SCR). Please contact your local Komatsu distributor for terms and conditions.



Easy radiator access

Thanks to a side-by-side cooler arrangement, the aftercooler and hydraulic oil radiator can be cleaned easily and repaired individually in case of damage.

Electric refuelling pump

Standard equipment on all PW148-11 includes an automatic shut-off fuelling pump that allows easy refuelling from a barrel.

Remote greasing bar

The PW148-11 features a centralised system that facilitates the regular greasing of the boom. An optional fully automatic greasing system can handle the regular and proper greasing of the complete machine – prolonging the lifetime and increasing the resale value of the excavator.

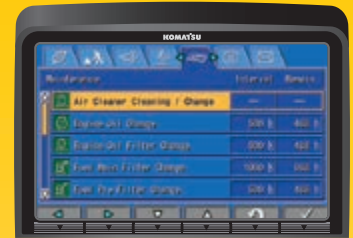

Basic maintenance screen

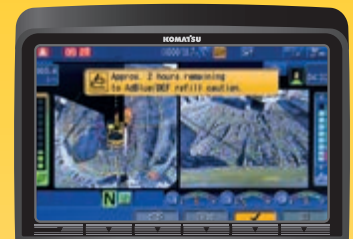

AdBlue® level and refill guidance



Simple access to the AdBlue® tank



Automatic greasing system (option)



PW148-11

KOMTRAX

The way to higher productivity

KOMTRAX uses the latest wireless monitoring technology. Compatible on PC, smartphone or tablet, it delivers insightful and cost saving information about your fleet and equipment, and offers a wealth of information to facilitate peak machine performance. By creating a tightly integrated web of support it allows proactive and preventive maintenance and helps to efficiently run a business.



Knowledge

You get quick answers to basic and critical questions about your machines – what they're doing, when they did it, where they're located, how they can be used more efficiently and when they need to be serviced. Performance data is relayed by wireless communication technology (satellite, GPRS or 3G depending on model) from the machine to a computer and to the local Komatsu distributor – who's readily available for expert analysis and feedback.

Power

The detailed information that KOMTRAX puts at your fingertips 24 hours a day, 7 days a week gives the power to make better daily and long-term strategic decisions – at no extra cost. Problems can be anticipated, maintenance schedules customised, downtime minimised and machines kept where they belong: working on the jobsite.

Convenience

KOMTRAX enables convenient fleet management on the web, wherever you are. Data is analysed and packaged specifically for effortless and intuitive viewing in maps, lists, graphs and charts. You can foresee eventual maintenance issues and required spare parts, and troubleshoot a problem before Komatsu technicians arrive on site.



Specifications

ENGINE

Model	Komatsu SAA4D107E-3
Type	Common rail direct injection, water-cooled, emissionised, turbocharged, after-cooled diesel
Engine power	
at rated engine speed	2.100 rpm
ISO 14396	90 kW / 121 HP
ISO 9249 (net engine power)	86 kW / 115 HP
No. of cylinders	4
Bore x stroke	107 x 124 mm
Displacement	4,5 l
Air filter type	Double element type with monitor panel dust indicator and auto evacuator
Cooling	Suction type cooling fan with radiator fly screen
Alternator	24 V / 85 A
Starter motor	24 V / 4,5 kW
Fuel	Diesel fuel, conforming to EN590 Class 2/Grade D. Paraffinic fuel capability (HVO, GTL, BTL), conforming to EN 15940:2016

HYDRAULIC SYSTEM

Type	HydrauMind. Closed-centre system with load sensing and pressure compensation valves
Additional circuits	Depending on the specification up to 2 additional proportional control & quick-coupler circuits can be installed
Main pump	Variable displacement piston pump supplying boom, arm, bucket, swing and travel circuits
Maximum pump flow	252 l/min
Relief valve settings	
Implement	380 kg/cm ²
Travel	420 kg/cm ²
Swing	280 kg/cm ²
Pilot circuit	36 kg/cm ²

SWING SYSTEM

Type	Axial piston motor driving through planetary double reduction gearbox
Swing lock	Electrically actuated wet multi-disc brake integrated into swing motor
Swing speed	0 - 11 rpm
Swing torque	31 kNm

STEERING SYSTEM

Steering control	Hydraulic steering system supplied from a separate gear pump and controlled through LS orbitrol & priority valves
Minimum turning radius	6.450 mm (to center of outer wheel)

BRAKE SYSTEM

Type	Dual circuit hydraulic braking system supplied from a separate gear pump
Service brakes	Pedal actuated wet multi-disc brakes integrated into the axle hubs
Parking brake	Electrically actuated wet multi-disc "spring actuation hydraulic release" brake integrated into the transmission

TRANSMISSION

Type	Fully automatic power shift transmission with permanent 4 wheel drive
Travel motors	One variable displacement axial piston motor
Maximum pressure	380 bar
Travel modes	Automatic + 3 travel modes
Max. travel speeds	
Hi / Lo / Creep	35,0 / 10,0 / 2,5 km/h
A max. speed restriction of 20 km/h is available as an option	
Maximum drawbar pull	8.300 kg
Axle oscillation	10° Lockable in any position from the operator cab

SERVICE REFILL CAPACITIES

Fuel tank	265 l
Radiator	22 l
Engine oil	18 l
Swing drive	2,5 l
Hydraulic tank	169 l
Transmission	3,0 l
Front differential	9,5 l
Rear differential	12,4 l
Front axle hub	2,5 l
Rear axle hub	2,5 l
Swing pinion grease bath amount	10,5 l
AdBlue® tank	29,6 l

ENVIRONMENT

Engine emissions	Fully complies with EU Stage IV exhaust emission regulations
Noise levels	
LwA external	101 dB(A) (2000/14/EC Stage II)
LpA operator ear	69 dB(A) (ISO 6396 dynamic test)
Vibration levels (EN 12096:1997)	
Hand/arm	≤ 2,5 m/s ² (uncertainty K = 0,34 m/s ²)
Body	≤ 0,5 m/s ² (uncertainty K = 0,16 m/s ²)
Contains fluorinated greenhouse gas HFC-134a (GWP 1430). Quantity of gas 0,9 kg, CO ₂ equivalent 1,29 t	

OPERATING WEIGHT (APPR.)

Undercarriage attachment type	Mono boom	Two-piece boom
Without	13.980 kg	14.215 kg
Rear blade	14.710 kg	14.945 kg
Rear outrigger	14.985 kg	15.220 kg
2 outriggers + blade	15.710 kg	15.945 kg
4 outriggers	15.980 kg	16.215 kg

Operating weight, including specified work equipment, 2.500 mm arm, operator, lubricant, coolant, full fuel tank, bucket (475 kg) and the standard equipment.

MAX. BUCKET CAPACITY AND WEIGHT

Arm length	Mono boom		
	2,1 m	2,5 m	3,0 m
Material weight up to 1,2 t/m ³	0,86 m ³ 600 kg	0,80 m ³ 550 kg	0,68 m ³ 500 kg
Material weight up to 1,5 t/m ³	0,73 m ³ 525 kg	0,68 m ³ 500 kg	0,58 m ³ 450 kg
Material weight up to 1,8 t/m ³	0,63 m ³ 475 kg	0,50 m ³ 450 kg	0,50 m ³ 425 kg
Arm length	Two-piece boom		
	2,1 m	2,5 m	3,0 m
Material weight up to 1,2 t/m ³	0,77 m ³ 550 kg	0,71 m ³ 525 kg	0,62 m ³ 475 kg
Material weight up to 1,5 t/m ³	0,65 m ³ 500 kg	0,60 m ³ 475 kg	0,53 m ³ 425 kg
Material weight up to 1,8 t/m ³	0,57 m ³ 450 kg	0,52 m ³ 425 kg	0,45 m ³ 400 kg

Max. capacity and weight have been calculated according to ISO 10567:2007.

Please consult with your distributor for the correct selection of buckets and attachments to suit the application.

BUCKET AND ARM FORCE

Arm length	2,1 m	2,5 m	3,0 m
Bucket digging force	86 kN	86 kN	86 kN
Bucket digging force at PowerMax	93 kN	93 kN	93 kN
Arm crowd force	74 kN	62 kN	52 kN
Arm crowd force at PowerMax	80 kN	67 kN	56 kN

Dimensions & Performance Figures

MONO BOOM

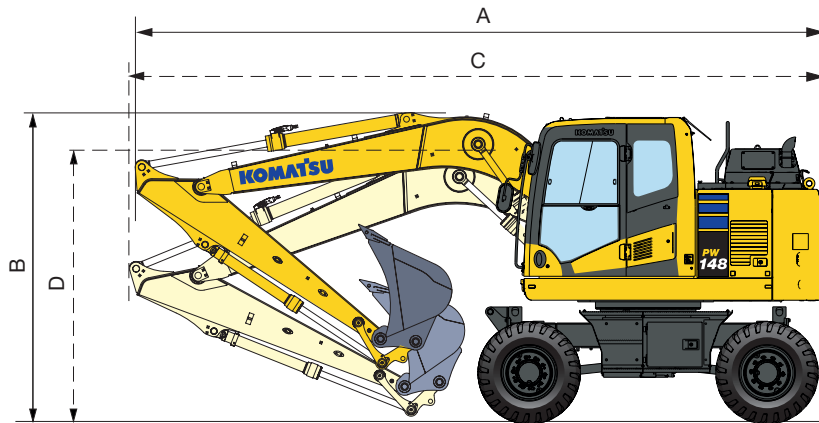

Driving position

Arm length	A	B
2.100 mm	7.120 mm	3.645 mm
2.500 mm	7.120 mm	3.645 mm
3.000 mm *	7.165 mm	3.665 mm

Transport position

Arm length	C	D
2.100 mm	7.370 mm	2.845 mm
2.500 mm	7.375 mm	2.945 mm
3.000 mm	7.390 mm	3.220 mm

* Driving position without bucket

TWO-PIECE BOOM

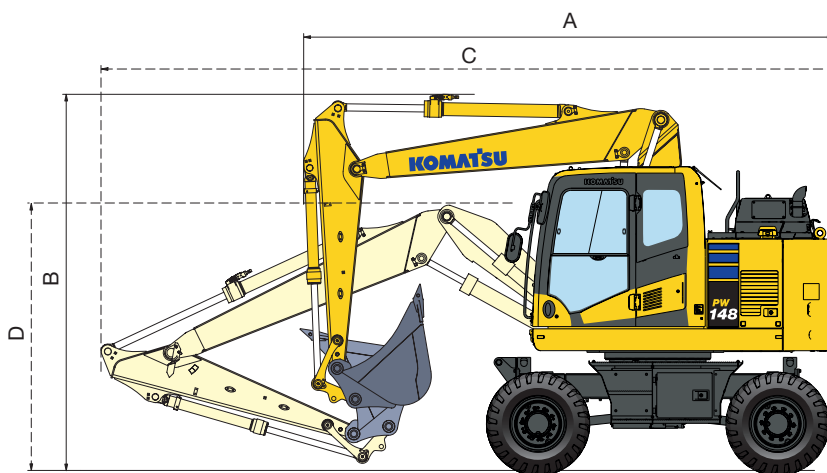

Driving position

Arm length	A	B
2.100 mm	5.635 mm	3.970 mm
2.500 mm	5.635 mm	3.970 mm
3.000 mm *	6.155 mm	3.970 mm

Transport position

Arm length	C	D**
2.100 mm	7.690 mm	3.155 mm
2.500 mm	7.690 mm	3.155 mm
3.000 mm	7.690 mm	3.155 mm

* Driving position without bucket

** Height to top of hose

PW148-11

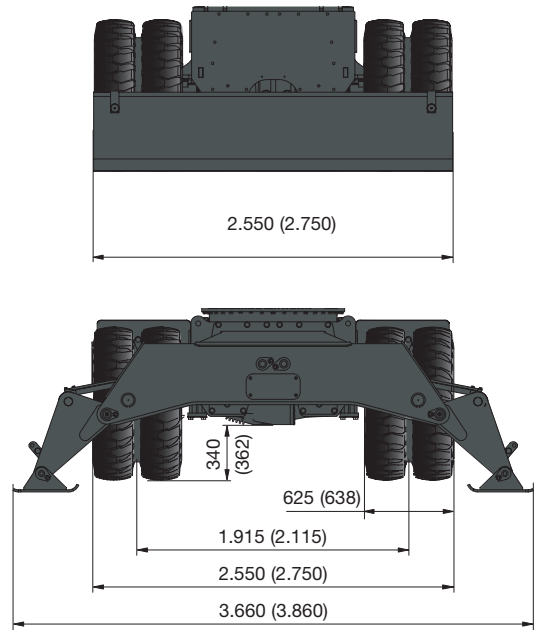
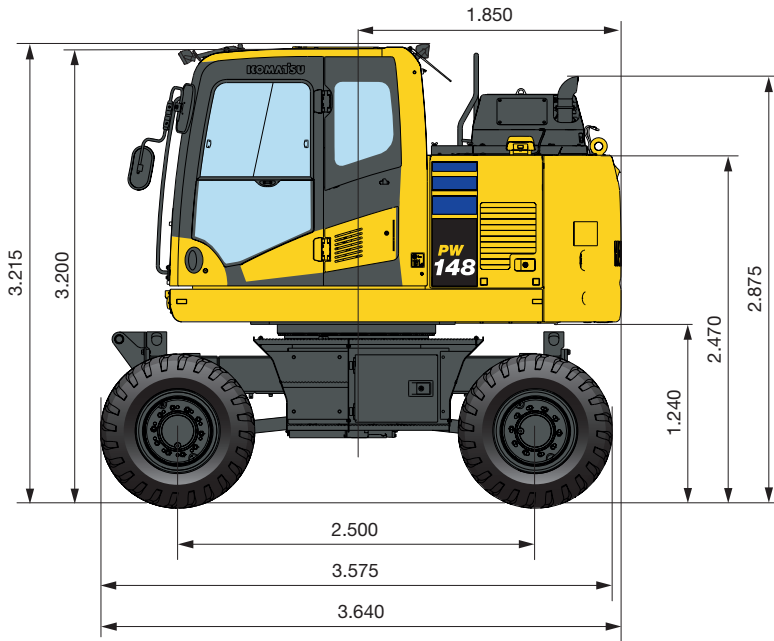

All dimensions with tyres Bandenmarkt Excavator 315/70 R22.5

(): Figures for 2,75 m undercarriage

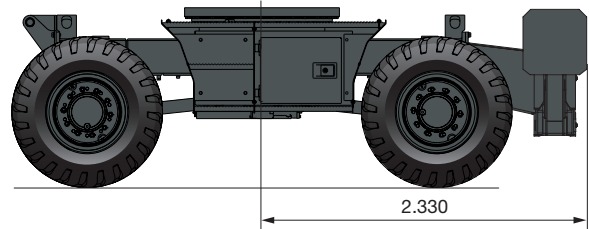
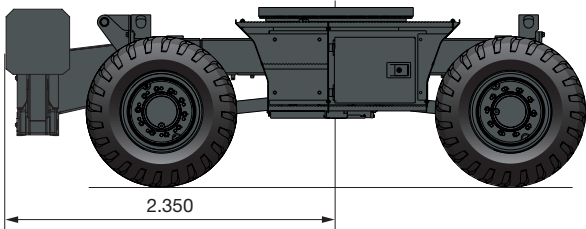
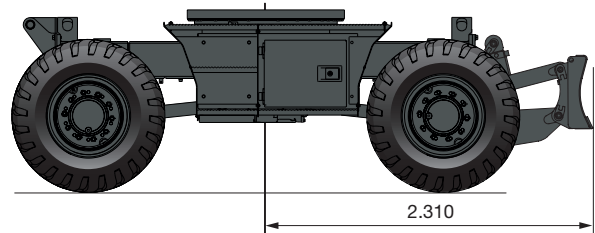
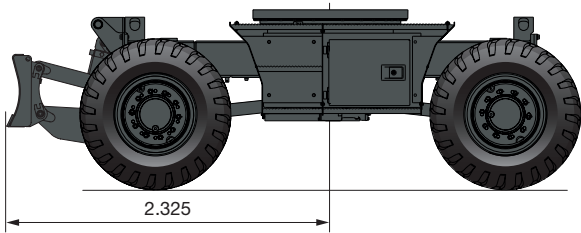

Working Range

MONO BOOM

PW148-11

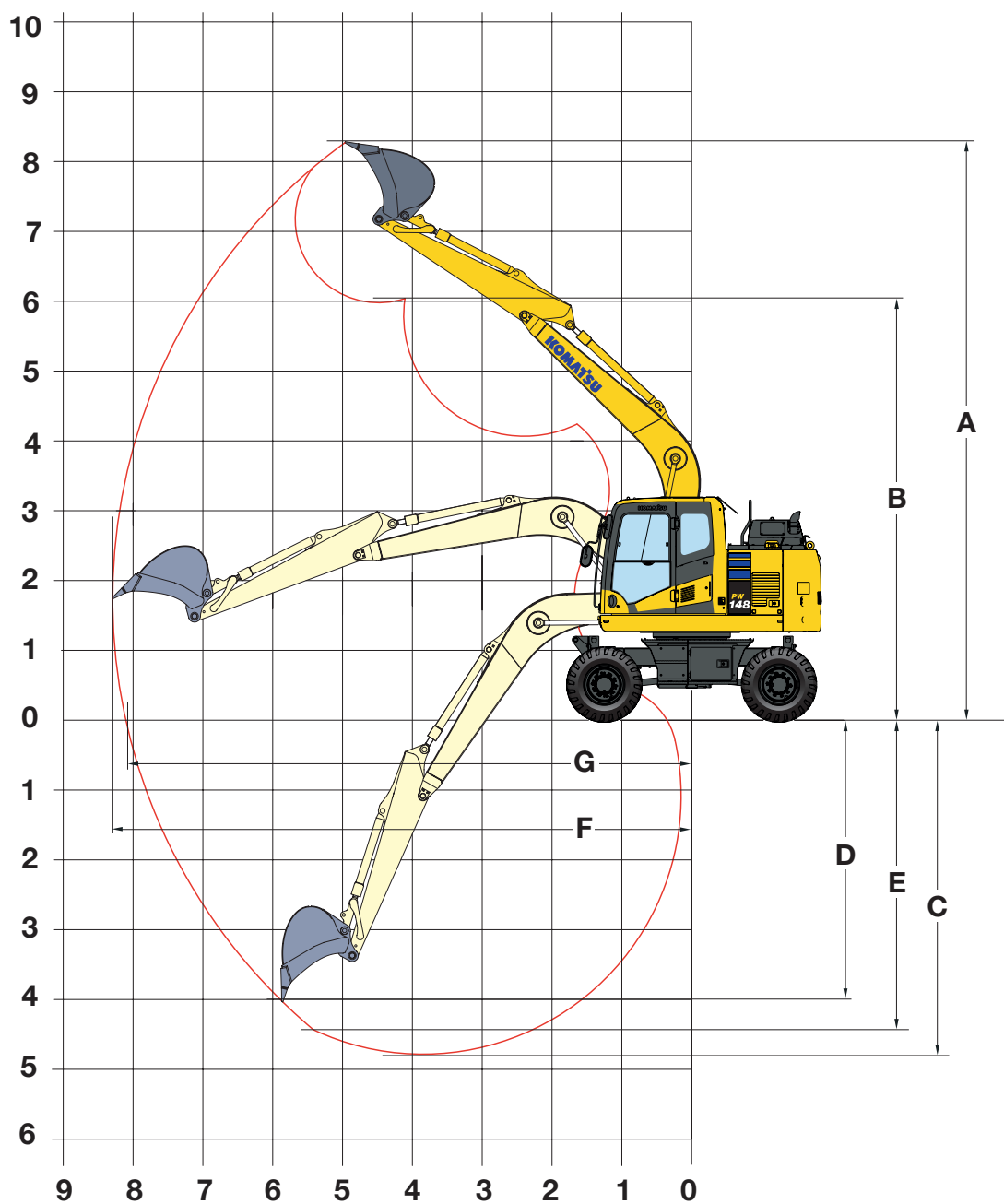

ARM LENGTH	2.100 mm	2.500 mm	3.000 mm
A Max. digging height	7.980 mm	8.270 mm	8.703 mm
B Max. dumping height	5.731 mm	6.020 mm	6.447 mm
C Max. digging depth	4.462 mm	4.860 mm	5.362 mm
D Max. vertical wall digging depth	3.630 mm	4.005 mm	4.470 mm
E Max. digging depth of cut for 2,44 m level	4.025 mm	4.570 mm	4.955 mm
F Max. digging reach	7.907 mm	8.320 mm	8.807 mm
G Max. digging reach at ground level	7.740 mm	8.140 mm	8.640 mm
Min. swing radius	2.965 mm	2.910 mm	2.925 mm



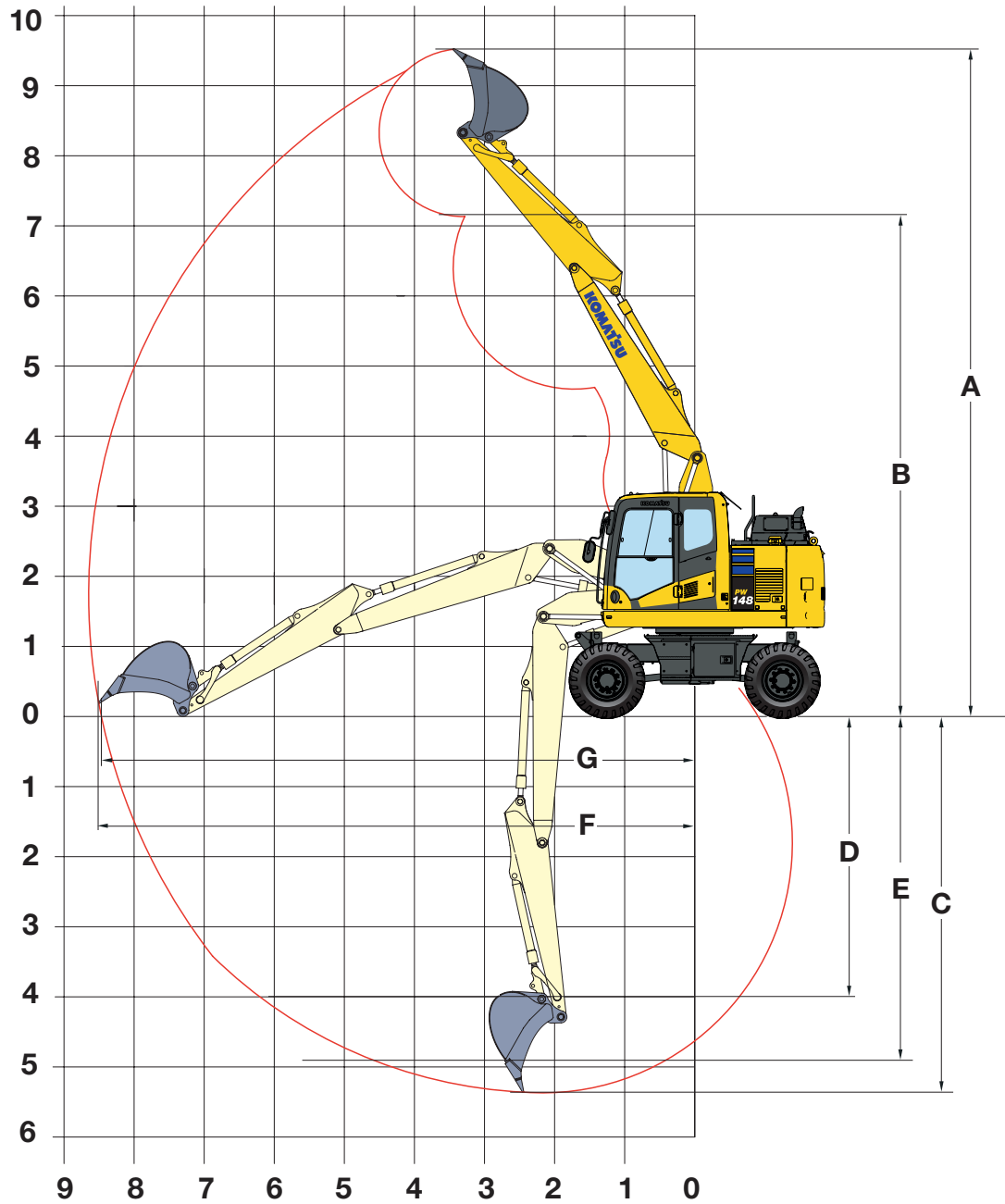









TWO-PIECE BOOM



ARM LENGTH	2.100 mm	2.500 mm	3.000 mm
A Max. digging height	9.228 mm	9.518 mm	9.951 mm
B Max. dumping height	6.844 mm	7.133 mm	7.562 mm
C Max. digging depth	5.091 mm	5.489 mm	5.991 mm
D Max. vertical wall digging depth	3.555 mm	4.000 mm	4.495 mm
E Max. digging depth of cut for 2,44 m level	4.515 mm	4.935 mm	5.460 mm
F Max. digging reach	8.268 mm	8.671 mm	9.168 mm
G Max. digging reach at ground level	8.100 mm	8.500 mm	9.000 mm
Min. swing radius	2.590 mm	2.670 mm	2.864 mm

Lifting Capacity

MONO BOOM / undercarriage width 2,55 m

Arm length	A	7,5 m		6,0 m		4,5 m		3,0 m		1,5 m		
												
 Without stabiliser	2,1 m	7,5 m kg										
		6,0 m kg	*2.850	2.400								
		4,5 m kg	2.500	1.850	2.800	2.100	4.500	3.300				
		3,0 m kg	2.150	1.650	2.800	2.000	4.350	3.000	8.300	5.700		
		1,5 m kg	2.100	1.500	2.700	1.950	4.050	2.950				
		0,0 m kg	2.150	1.600	2.600	1.900	3.750	2.800	7.350	4.900		
	2,5 m	-1,5 m kg	2.450	1.750	2.550	1.800	3.900	2.700	7.350	4.900	*6.350	*6.350
		-3,0 m kg	3.300	2.250			3.900	2.700	*6.550	5.000		
		7,5 m kg										
		6,0 m kg	*2.350	2.150	*2.550	2.150						
		4,5 m kg	*2.250	1.700	2.850	2.100						
		3,0 m kg	2.100	1.500	2.750	2.100	4.350	3.200	*8.050	5.900		
3,0 m	1,5 m kg	1.950	1.400	2.550	1.950	4.100	3.000	7.800	5.200			
	0,0 m kg	2.000	1.450	2.600	1.850	3.850	2.700	7.350	4.800			
	-1,5 m kg	2.200	1.600	2.550	1.850	3.850	2.700	7.350	4.850	*5.750	*5.750	
	-3,0 m kg	2.700	2.000			3.900	2.750	7.400	4.950			
	7,5 m kg	*2.300	*2.300									
	6,0 m kg	*2.000	1.800	2.900	2.150							
 Front or rear blade	2,1 m	4,5 m kg										
		3,0 m kg	*2.700	2.200	*4.050	2.500	*5.150	3.900				
		1,5 m kg	*2.700	1.950	*4.850	2.400	*6.050	3.700	*8.850	6.750		
		0,0 m kg	*2.800	1.800	*5.100	2.300	*6.800	3.450				
		-1,5 m kg	*3.150	1.900	*5.100	2.250	*7.050	3.300	*7.700	5.900		
		-3,0 m kg	*3.900	2.100	*4.450	2.250	*6.400	3.250	*9.200	5.900	*6.350	*6.350
	2,5 m	7,5 m kg										
		6,0 m kg	*2.350	*2.400	*2.550	2.550						
		4,5 m kg	*2.250	2.000	*4.150	2.550						
		3,0 m kg	*2.250	1.800	*4.700	2.450	*5.700	3.750	*8.050	7.000		
		1,5 m kg	*2.350	1.700	*5.050	2.350	*6.650	3.500	*10.050	6.300		
		0,0 m kg	*2.650	1.750	*5.150	2.250	*7.050	3.300	*8.150	5.950		
3,0 m	-1,5 m kg	*3.150	1.950	*4.750	2.200	*6.700	3.250	*9.800	5.850	*5.750	*5.750	
	-3,0 m kg	*3.600	2.400	*5.250	3.300	*7.550	6.000					
	7,5 m kg	*2.300	*2.300									
	6,0 m kg	*2.000	*2.000	*3.300	2.550							
	4,5 m kg	*1.850	1.750	*3.950	2.500							
	3,0 m kg	*1.850	1.550	*3.050	1.650	*4.350	2.400	*5.150	3.750			
 Rear outrigger	2,1 m	1,5 m kg	*1.950	1.500	*3.600	1.650	*4.750	2.250	*6.200	3.450	*9.750	6.300
		0,0 m kg	*2.100	1.500	*3.350	1.550	*5.050	2.150	*6.850	3.250	*8.600	5.850
		-1,5 m kg	*2.500	1.650	*4.850	2.100	*6.750	3.150	*10.250	5.700	*5.000	*5.000
		-3,0 m kg	*3.300	2.000	*3.850	2.100	*5.700	3.150	*8.400	5.750	*8.050	*8.050
		7,5 m kg										
		6,0 m kg	*2.850	*2.850								
	2,5 m	4,5 m kg	*2.700	*2.650	*4.050	3.150	*5.150	5.000				
		3,0 m kg	*2.700	2.500	*4.850	3.100	*6.050	4.800	*8.850	*8.850		
		1,5 m kg	*2.800	2.400	*5.100	3.000	*6.800	4.500				
		0,0 m kg	*3.150	2.450	*5.100	2.950	*7.050	4.350	*7.700	*7.700		
		-1,5 m kg	*3.900	2.750	*4.450	2.900	*6.400	4.350	9.200	8.300	*6.350	*6.350
		-3,0 m kg	*3.500	*3.500			*4.600	4.400	*6.550	*6.550		
3,0 m	7,5 m kg											
	6,0 m kg	*2.350	*2.350	*2.550	*2.550							
	4,5 m kg	*2.250	*2.250	*4.150	3.200							
	3,0 m kg	*2.250	*2.300	*4.700	3.150	*5.700	4.850	*8.050	*8.050			
	1,5 m kg	*2.350	2.250	*5.050	3.000	*6.650	4.600	*10.050	8.700			
	0,0 m kg	*2.650	2.250	*5.150	2.950	*7.050	4.400	*8.150	*8.150			
3,0 m	-1,5 m kg	*3.150	2.550	*4.750	2.900	*6.700	4.350	*9.800	8.250	*5.750	*5.750	
	-3,0 m kg	*3.600	3.150	*5.250	4.350	*7.550	*7.550					
	7,5 m kg	*2.300	*2.300									
	6,0 m kg	*2.000	*2.000	*3.300	3.250							
	4,5 m kg	*1.850	*1.850	*3.950	3.200							
	3,0 m kg	*1.850	*1.850	*3.050	2.200	*4.350	3.100	*5.150	4.850			
3,0 m	1,5 m kg	*1.950	1.950	*3.600	2.100	*4.750	3.000	*6.200	4.550	*9.750	8.750	
	0,0 m kg	2.100	1.950	*3.350	2.100	*5.050	2.850	*6.850	4.350	*8.600	8.250	
	-1,5 m kg	*2.500	2.150	*4.850	2.800	*6.750	4.200	*10.250	8.100	*5.000	*5.000	
	-3,0 m kg	*3.300	2.650	*3.850	2.800	*5.700	4.200	*8.400	8.100	*8.050	*8.050	

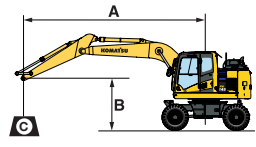

A – Reach from swing center

B – Bucket hook height

C – Lifting capacities, including bucket linkage (84 kg) and bucket cylinder (96 kg)

 – Rating over front

 – Rating over side

 – Rating at maximum reach

When removing linkage or cylinder, lifting capacities can be increased by their respective weights.

* Load is limited by hydraulic capacity rather than tipping. Ratings are based on ISO standard 10567. Rated loads do not exceed 87% of hydraulic lift capacity or 75% of tipping load.

PW148-11

Arm length	A	⊗		7,5 m		6,0 m		4,5 m		3,0 m		1,5 m			
		B	⊗		⊗		⊗		⊗		⊗		⊗		
			⊗	⊗	⊗	⊗	⊗	⊗	⊗	⊗	⊗	⊗	⊗	⊗	
 <p>Outrigger + blade</p>	2,1 m	7,5 m	kg												
		6,0 m	kg	*2.850	*2.850										
		4,5 m	kg	*2.700	*2.700		*4.050	3.950	*5.150	*5.150					
		3,0 m	kg	*2.700	*2.700		*4.850	3.900	*6.050	*6.000	*8.850	*8.850			
		1,5 m	kg	*2.800	*2.800		*5.100	3.750	*6.800	5.800					
		0,0 m	kg	*3.150	3.100		*5.100	3.700	*7.050	5.650	*7.700	*7.700			
		-1,5 m	kg	*3.900	3.450		*4.450	3.650	*6.400	5.550	*9.200	*9.200	*6.350	*6.350	
		-3,0 m	kg	*3.500	*3.500				*4.600	*4.600	*6.550	*6.550			
	2,5 m	7,5 m	kg												
		6,0 m	kg	*2.350	*2.350		*2.550	*2.550							
		4,5 m	kg	*2.250	*2.250		*4.150	4.000							
		3,0 m	kg	*2.250	*2.250		*4.700	3.900	*5.700	*5.700	*8.050	*8.050			
		1,5 m	kg	*2.350	*2.350		*5.050	3.800	*6.650	5.850	*10.050	*10.050			
		0,0 m	kg	*2.650	*2.650		*5.150	3.700	*7.050	5.650	*8.150	*8.150			
		-1,5 m	kg	*3.150	*3.150		*4.750	3.650	*6.700	5.550	*9.800	*9.800	*5.750	*5.750	
		-3,0 m	kg	*3.600	*3.600				*5.250	*5.250	*7.550	*7.550			
	3,0 m	7,5 m	kg	*2.300	*2.300										
		6,0 m	kg	*2.000	*2.000		*3.300	*3.300							
		4,5 m	kg	*1.850	*1.850		*3.950	*3.950							
		3,0 m	kg	*1.850	*1.850	*3.050	2.700	*4.350	3.900	*5.150	*5.150				
		1,5 m	kg	*1.950	*1.950	*3.600	2.700	*4.750	3.750	*6.200	5.850	*9.750	*9.750		
		0,0 m	kg	*2.100	*2.100	*3.350	2.650	*5.050	3.600	*6.850	5.550	*8.600	*8.600		
		-1,5 m	kg	*2.500	*2.500			*4.850	3.550	*6.750	5.450	*10.250	*10.250	*5.000	*5.000
		-3,0 m	kg	*3.300	*3.300			*3.850	3.600	*5.700	5.400	*8.400	*8.400	*8.050	*8.050

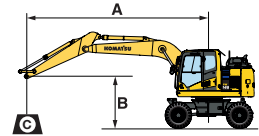

A – Reach from swing center

B – Bucket hook height

C – Lifting capacities, including bucket linkage (84 kg) and bucket cylinder (96 kg)

⊗ – Rating over front

⊗ – Rating over side

⊗ – Rating at maximum reach



When removing linkage or cylinder, lifting capacities can be increased by their respective weights.

* Load is limited by hydraulic capacity rather than tipping. Ratings are based on ISO standard 10567. Rated loads do not exceed 87% of hydraulic lift capacity or 75% of tipping load.

 <p>Outrigger front + rear</p>	2,1 m	7,5 m	kg												
		6,0 m	kg	*2.850	*2.850										
		4,5 m	kg	*2.700	*2.700		*4.050	*4.050	*5.150	*5.150					
		3,0 m	kg	*2.700	*2.700		*4.850	*4.850	*6.050	*6.050	*8.850	*8.850			
		1,5 m	kg	*2.800	*2.800		*5.100	4.800	*6.800	*6.800					
		0,0 m	kg	*3.150	*3.150		*5.100	4.700	*7.050	*7.050	*7.700	*7.700			
		-1,5 m	kg	*3.900	*3.900		*4.450	*4.450	*6.400	*6.400	*9.200	*9.200	*6.350	*6.350	
		-3,0 m	kg	*3.500	*3.500				*4.600	*4.600	*6.550	*6.550			
	2,5 m	7,5 m	kg												
		6,0 m	kg	*2.350	*2.350		*2.550	*2.550							
		4,5 m	kg	*2.250	*2.250		*4.150	*4.150							
		3,0 m	kg	*2.250	*2.250		*4.700	*4.700	*5.700	*5.700	*8.050	*8.050			
		1,5 m	kg	*2.350	*2.350		*5.050	4.800	*6.650	*6.650	*10.050	*10.050			
		0,0 m	kg	*2.650	*2.650		*5.150	4.700	*7.050	*7.050	*8.150	*8.150			
		-1,5 m	kg	*3.150	*3.150		*4.750	4.650	*6.700	*6.700	*9.800	*9.800	*5.750	*5.750	
		-3,0 m	kg	*3.600	*3.600				*5.250	*5.250	*7.550	*7.550			
	3,0 m	7,5 m	kg	*2.300	*2.300										
		6,0 m	kg	*2.000	*2.000		*3.300	*3.300							
		4,5 m	kg	*1.850	*1.850		*3.950	*3.950							
		3,0 m	kg	*1.850	*1.850	*3.050	*3.050	*4.350	*4.350	*5.150	*5.150				
		1,5 m	kg	*1.950	*1.950	*3.600	3.400	*4.750	*4.750	*6.200	*6.200	*9.750	*9.750		
		0,0 m	kg	*2.100	*2.100	*3.350	3.300	*5.050	4.450	*6.850	*6.850	*8.600	*8.600		
		-1,5 m	kg	*2.500	*2.500			*4.850	4.550	*6.750	*6.750	*10.250	*10.250	*5.000	*5.000
		-3,0 m	kg	*3.300	*3.300			*3.850	*3.850	*5.700	*5.700	*8.400	*8.400	*8.050	*8.050

Lifting Capacity

TWO-PIECE BOOM / undercarriage width 2,55 m

Arm length	A B	⊗		7,5 m		6,0 m		4,5 m		3,0 m		1,5 m		
 <p>Without stabiliser</p>	2,1 m	7,5 m kg	*3.550	3.300					*3.700	3.300				
		6,0 m kg	2.850	2.100		2.850	2.100	*4.050	3.450					
		4,5 m kg	2.250	1.650		2.800	2.100	4.500	3.300					
		3,0 m kg	1.950	1.500		2.700	2.000	4.250	3.050					
		1,5 m kg	1.950	1.350		2.550	1.900	4.000	2.700					
		0,0 m kg	1.950	1.450		2.550	1.800	3.850	2.700					
		-1,5 m kg	2.200	1.600		2.550	1.800	3.800	2.650	7.250	4.800			
		-3,0 m kg												
		2,5 m	7,5 m kg	*2.850	2.750					*3.950	3.450			
	6,0 m kg		*2.400	1.850		2.950	2.150							
	4,5 m kg		2.100	1.500		2.900	2.100	4.350	3.350					
	3,0 m kg		1.800	1.350	1.950	1.400	2.800	2.050	4.350	3.150				
	1,5 m kg		1.800	1.300	1.950	1.400	2.550	1.900	4.050	2.850				
	0,0 m kg		1.800	1.350	1.900	1.350	2.550	1.800	3.600	2.700	*5.450	4.750		
	-1,5 m kg		2.050	1.450		2.550	1.800	3.800	2.650	7.200	4.700			
	-3,0 m kg		2.650	1.850				3.750	2.700					
	3,0 m		7,5 m kg	*2.300	2.150									
		6,0 m kg	*2.000	1.600		2.950	2.150							
		4,5 m kg	1.800	1.300	1.950	1.400	2.850	2.100	*3.850	3.400				
		3,0 m kg	1.650	1.200	1.950	1.350	2.700	2.000	4.150	3.150				
		1,5 m kg	1.550	1.100	1.850	1.350	2.600	1.850	4.050	2.850				
		0,0 m kg	1.600	1.150	1.800	1.250	2.400	1.700	3.750	2.600	*5.700	4.650		
		-1,5 m kg	1.700	1.200	1.800	1.250	2.300	1.700	3.650	2.550	7.000	4.550	*3.900	*3.900
		-3,0 m kg	2.100	1.500		2.350	1.650	3.650	2.550	7.050	4.600			
 <p>Front or rear blade</p>		2,1 m	7,5 m kg	*3.550	*3.550					*3.700	*3.650			
	6,0 m kg		*2.900	2.450		*3.050	2.450	*4.050	3.950					
	4,5 m kg		*2.700	1.950		*4.100	2.450	*5.200	3.850					
	3,0 m kg		*2.700	1.750		*4.350	2.400	*5.850	3.600					
	1,5 m kg		*2.750	1.650		*4.700	2.250	*6.850	3.350					
	0,0 m kg		*3.050	1.700		*5.050	2.200	*6.900	3.200					
	-1,5 m kg		*3.550	1.950		*4.450	2.150	*6.200	3.150	*8.500	5.850			
	-3,0 m kg													
	2,5 m		7,5 m kg	*2.850	*2.850					*3.950	*3.950			
		6,0 m kg	*2.400	2.200		*3.750	2.550							
		4,5 m kg	*2.300	1.800		*4.000	2.500	*4.950	3.900					
		3,0 m kg	*2.250	1.650	*3.350	1.700	*4.200	2.400	*5.600	3.650				
		1,5 m kg	*2.350	1.550	*3.600	1.650	*4.600	2.250	*6.600	3.400				
		0,0 m kg	*2.550	1.600	*3.350	1.650	*5.000	2.200	*6.950	3.250	*5.450	*5.450		
		-1,5 m kg	*2.950	1.750		*4.700	2.150	*6.450	3.150	*8.600	5.750			
		-3,0 m kg	*3.400	2.250				*5.100	3.200					
		3,0 m	7,5 m kg	*2.300	*2.300									
	6,0 m kg		*2.000	1.850		*3.700	2.550							
	4,5 m kg		*1.900	1.550	*3.000	1.650	*3.750	2.500	*3.850	*3.850				
	3,0 m kg		*1.850	1.400	*3.250	1.650	*4.000	2.400	*5.200	3.700				
	1,5 m kg		*1.900	1.350	*3.350	1.600	*4.300	2.250	*6.050	3.400				
	0,0 m kg		*2.050	1.350	*3.600	1.500	*4.700	2.100	*6.800	3.150	*5.700	5.700		
	-1,5 m kg		*2.350	1.500	*3.250	1.500	*4.750	2.050	*6.550	3.050	*7.800	5.550	*3.900	*3.900
	-3,0 m kg		*2.800	1.800		*3.850	2.100	*5.550	3.050	*7.800	5.650			
 <p>Rear outrigger</p>	2,1 m		7,5 m kg	*3.550	*3.550					*3.700	*3.700			
		6,0 m kg	*2.900	*2.950		*3.050	*3.000	*4.050	*4.050					
		4,5 m kg	*2.700	2.550		*4.100	3.150	*5.200	4.950					
		3,0 m kg	*2.700	2.250		*4.350	3.050	*5.850	4.700					
		1,5 m kg	*2.750	2.200		*4.700	2.950	*6.850	4.450					
		0,0 m kg	*3.050	2.250		*5.050	2.850	*6.900	4.300					
		-1,5 m kg	*3.550	2.500		*4.450	2.850	*6.200	4.250	*8.500	8.150			
		-3,0 m kg												
		2,5 m	7,5 m kg	*2.850	*2.850					*3.950	*3.950			
	6,0 m kg		*2.400	*2.400		*3.750	3.250							
	4,5 m kg		*2.300	*2.300		*4.000	3.200	*4.950	*4.950					
	3,0 m kg		*2.250	2.100	*3.350	2.200	*4.200	3.100	*5.600	4.800				
	1,5 m kg		*2.350	2.050	*3.600	2.150	*4.600	3.000	*6.600	4.500				
	0,0 m kg		*2.550	2.100	*3.350	2.100	*5.000	2.850	*6.950	4.350	*5.450	*5.450		
	-1,5 m kg		*2.950	2.300		*4.700	2.850	*6.450	4.250	*8.600	8.150			
	-3,0 m kg		*3.400	2.950				*5.100	4.300					
	3,0 m		7,5 m kg	*2.300	*2.300									
		6,0 m kg	*2.000	*2.000		*3.700	3.250							
		4,5 m kg	*1.900	*1.900	*3.000	2.200	*3.750	3.200	*3.850	*3.850				
		3,0 m kg	*1.850	*1.850	*3.250	2.150	*4.000	3.050	*5.200	4.800				
		1,5 m kg	*1.900	1.800	*3.350	2.100	*4.300	2.950	*6.050	4.500				
		0,0 m kg	*2.050	1.800	*3.600	2.050	*4.700	2.800	*6.800	4.200	*5.700	*5.700		
		-1,5 m kg	*2.350	2.000	*3.250	2.050	*4.750	2.750	*6.550	4.150	*7.800	*7.800	*3.900	*3.900
		-3,0 m kg	*2.800	2.400		*3.850	2.750	*5.550	4.150	*7.800	*7.900			

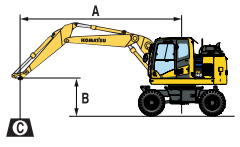

A – Reach from swing center

B – Bucket hook height

C – Lifting capacities, including bucket linkage (84 kg) and bucket cylinder (96 kg)

– Rating over front

– Rating over side

– Rating at maximum reach

When removing linkage or cylinder, lifting capacities can be increased by their respective weights.

* Load is limited by hydraulic capacity rather than tipping. Ratings are based on ISO standard 10567. Rated loads do not exceed 87% of hydraulic lift capacity or 75% of tipping load.

PW148-11

Arm length	A	⊗		7,5 m		6,0 m		4,5 m		3,0 m		1,5 m		
		⊗	⊗	⊗	⊗	⊗	⊗	⊗	⊗	⊗	⊗	⊗	⊗	
 <p>Outrigger + blade</p>	2,1 m	7,5 m	kg	*3.550	*3.550			*3.700	*3.700					
		6,0 m	kg	*2.900	*2.900		*3.050	*3.050	*4.050	*4.050				
		4,5 m	kg	*2.700	*2.700		*4.100	3.950	*5.200	*5.200				
		3,0 m	kg	*2.700	*2.700		*4.350	3.850	*5.850	*5.850				
		1,5 m	kg	*2.750	2.700		*4.700	3.750	*6.850	5.700				
		0,0 m	kg	*3.050	2.850		*5.050	3.650	*6.900	5.550				
	2,5 m	-1,5 m	kg	*3.550	3.150		*4.450	3.600	*6.200	5.500	*8.500	*8.500		
		-3,0 m	kg											
		7,5 m	kg	*2.850	*2.850				*3.950	*3.950				
		6,0 m	kg	*2.400	*2.400		*3.750	*3.750						
		4,5 m	kg	*2.300	*2.300		*4.000	*4.000	*4.950	*4.950				
		3,0 m	kg	*2.250	*2.250	*3.350	2.650	*4.200	3.900	*5.600	*5.600			
3,0 m	1,5 m	kg	*2.350	*2.350	*3.600	2.700	*4.600	3.750	*6.600	5.750				
	0,0 m	kg	*2.550	*2.550	*3.350	2.700	*5.000	3.650	*6.950	5.550	*5.450	*5.450		
	-1,5 m	kg	*2.950	2.900			*4.700	3.600	*6.450	5.500	*8.600	*8.600		
	-3,0 m	kg	*3.400	*3.400					*5.100	*5.050				
	7,5 m	kg	*2.300	*2.300										
	6,0 m	kg	*2.000	*2.000			*3.700	*3.700						

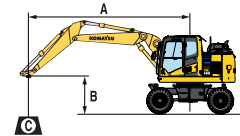

A – Reach from swing center

B – Bucket hook height

C – Lifting capacities, including bucket linkage (84 kg) and bucket cylinder (96 kg)

⊗ – Rating over front

⊗ – Rating over side

⊗ – Rating at maximum reach



When removing linkage or cylinder, lifting capacities can be increased by their respective weights.

* Load is limited by hydraulic capacity rather than tipping. Ratings are based on ISO standard 10567. Rated loads do not exceed 87% of hydraulic lift capacity or 75% of tipping load.

 <p>Outrigger front + rear</p>	2,1 m	7,5 m	kg	*3.550	*3.550			*3.700	*3.700					
		6,0 m	kg	*2.900	*2.900		*3.050	*3.050	*4.050	*4.050				
		4,5 m	kg	*2.700	*2.700		*4.100	*4.100	*5.200	*5.200				
		3,0 m	kg	*2.700	*2.700		*4.350	*4.350	*5.850	*5.850				
		1,5 m	kg	*2.750	*2.750		*4.700	*4.700	*6.850	*6.850				
		0,0 m	kg	*3.050	*3.050		*5.050	4.350	*6.900	*6.900				
	2,5 m	-1,5 m	kg	*3.550	*3.550		*4.450	*4.450	*6.200	*6.200	*8.500	*8.500		
		-3,0 m	kg											
		7,5 m	kg	*2.850	*2.850				*3.950	*3.950				
		6,0 m	kg	*2.400	*2.400		*3.750	*3.750						
		4,5 m	kg	*2.300	*2.300		*4.000	*4.000	*4.950	*4.950				
		3,0 m	kg	*2.250	*2.250	*3.350	*3.350	*4.200	*4.200	*5.600	*5.600			
3,0 m	1,5 m	kg	*2.350	*2.350	*3.600	3.300	*4.600	*4.600	*6.600	*6.600				
	0,0 m	kg	*2.550	*2.550	*3.350	*3.350	*5.000	4.650	*6.950	*6.950	*5.450	*5.450		
	-1,5 m	kg	*2.950	*2.950			*4.700	4.650	*6.450	*6.450	*8.600	*8.600		
	-3,0 m	kg	*3.400	*3.400					*5.100	*5.100				
	7,5 m	kg	*2.300	*2.300										
	6,0 m	kg	*2.000	*2.000			*3.700	*3.700						

Lifting Capacity

MONO BOOM / undercarriage width 2,75 m

Arm length	A B	⊗		7,5 m		6,0 m		4,5 m		3,0 m		1,5 m		
 Without stabiliser	2,1 m	7,5 m kg												
		6,0 m kg	*2.850	2.700										
		4,5 m kg	2.550	2.100		2.900	2.400	4.650	3.750					
		3,0 m kg	2.250	1.850		2.850	2.350	4.400	3.550	8.450	6.600			
		1,5 m kg	2.150	1.800		2.750	2.250	4.150	3.300					
		0,0 m kg	2.250	1.800		2.700	2.150	4.000	3.150	7.500	5.700			
	2,5 m	-1,5 m kg	2.550	2.050		2.650	2.150	3.950	3.150	7.500	5.700	*6.350	*6.350	
		-3,0 m kg	3.300	2.700				4.000	3.200	*6.550	5.850			
		7,5 m kg												
		6,0 m kg	*2.350	*2.350		*2.550	2.450							
		4,5 m kg	*2.250	1.950		3.000	2.450							
		3,0 m kg	2.100	1.700		2.850	2.350	4.500	3.600	*8.050	6.750			
3,0 m	1,5 m kg	2.000	1.650		2.750	2.250	4.200	3.400	7.950	6.050				
	0,0 m kg	2.100	1.650		2.700	2.150	4.050	3.200	7.550	5.700				
	-1,5 m kg	2.300	1.850		2.650	2.100	3.900	3.150	7.450	5.700	*5.750	*5.750		
	-3,0 m kg	2.900	2.350				3.950	3.150	7.550	5.750				
	7,5 m kg	*2.300	*2.300											
	6,0 m kg	*2.000	*2.000		3.000	2.450								
 Front or rear blade	2,1 m	7,5 m kg												
		6,0 m kg	*2.850	*2.900										
		4,5 m kg	*2.700	2.450		*4.050	2.800	*5.150	4.350					
		3,0 m kg	*2.700	2.150		*4.850	2.700	*6.050	4.150	*8.850	7.850			
		1,5 m kg	*2.800	2.100		*5.100	2.600	*6.800	3.900					
		0,0 m kg	*3.150	2.100		*5.100	2.550	*7.050	3.750	*7.700	6.900			
	2,5 m	-1,5 m kg	*3.900	2.400		*4.450	2.550	*6.400	3.750	*9.200	6.900	*6.350	*6.350	
		-3,0 m kg	*3.500	3.150				*4.600	3.750	*6.550	*6.550			
		7,5 m kg												
		6,0 m kg	*2.350	*2.350		*2.550	*2.550							
		4,5 m kg	*2.250	*2.250		*4.150	2.850							
		3,0 m kg	*2.250	2.000		*4.700	2.750	*5.700	4.200	*8.050	8.000			
3,0 m	1,5 m kg	*2.350	1.950		*5.050	2.650	*6.650	3.950	*10.050	7.250				
	0,0 m kg	*2.650	1.950		*5.150	2.550	*7.050	3.750	*8.150	6.900				
	-1,5 m kg	*3.150	2.200		*4.750	2.500	*6.700	3.700	*9.800	6.900	*5.750	*5.750		
	-3,0 m kg	*3.600	2.750				*5.250	3.750	*7.550	6.950				
	7,5 m kg	*2.300	*2.300											
	6,0 m kg	*2.000	*2.000		*3.300	2.850								
 Rear outrigger	2,1 m	7,5 m kg												
		6,0 m kg	*2.850	*2.850										
		4,5 m kg	*2.700	*2.650		*4.050	3.450	*5.150	*5.150					
		3,0 m kg	*2.700	*2.650		*4.850	3.400	*6.050	5.250	*8.850	*8.850			
		1,5 m kg	*2.800	2.600		*5.100	3.300	*6.800	5.000					
		0,0 m kg	*3.150	2.700		*5.100	3.200	*7.050	4.850	*7.700	*7.700			
	2,5 m	-1,5 m kg	*3.900	3.050		*4.450	3.200	*6.400	4.800	*9.200	*9.200	*6.350	*6.350	
		-3,0 m kg	*3.500	*3.500				*4.600	*4.600	*6.550	*6.550			
		7,5 m kg												
		6,0 m kg	*2.350	*2.350		*2.550	*2.550							
		4,5 m kg	*2.250	*2.250		*4.150	3.550							
		3,0 m kg	*2.250	*2.300		*4.700	3.450	*5.700	5.350	*8.050	*8.050			
3,0 m	1,5 m kg	*2.350	*2.350		*5.050	3.300	*6.650	5.100	*10.050	9.800				
	0,0 m kg	*2.650	2.500		*5.150	3.250	*7.050	4.900	*8.150	*8.150				
	-1,5 m kg	*3.150	2.750		*4.750	3.200	*6.700	4.800	*9.800	9.350	*5.750	*5.750		
	-3,0 m kg	*3.600	3.500				*5.250	4.800	*7.550	*7.550				
	7,5 m kg	*2.300	*2.300											
	6,0 m kg	*2.000	*2.000		*3.300	*3.300								

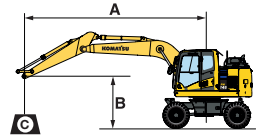

A – Reach from swing center

B – Bucket hook height

C – Lifting capacities, including bucket linkage (84 kg) and bucket cylinder (96 kg)

– Rating over rear/front

– Rating over side

– Rating at maximum reach

When removing linkage or cylinder, lifting capacities can be increased by their respective weights.

* Load is limited by hydraulic capacity rather than tipping. Ratings are based on ISO standard 10567. Rated loads do not exceed 87% of hydraulic lift capacity or 75% of tipping load.

PW148-11

Arm length	A	⊗		7,5 m		6,0 m		4,5 m		3,0 m		1,5 m		
		⊗	⊗	⊗	⊗	⊗	⊗	⊗	⊗	⊗	⊗	⊗	⊗	
 <p>Outrigger + blade</p>	2,1 m	7,5 m	kg											
		6,0 m	kg	*2.850	*2.850									
		4,5 m	kg	*2.700	*2.700			*4.050	*4.050	*5.150	*5.150			
		3,0 m	kg	*2.700	*2.700			*4.850	4.250	*6.050	*6.050	*8.850	*8.850	
		1,5 m	kg	*2.800	*2.800			*5.100	4.150	*6.800	6.450			
		0,0 m	kg	*3.150	*3.150			*5.100	4.050	*7.050	6.250	*7.700	*7.700	
	2,5 m	-1,5 m	kg	*3.900	3.850			*4.450	4.050	*6.400	6.200	*9.200	*9.200	*6.350 *6.350
		-3,0 m	kg	*3.500	*3.500					*4.600	*4.600	*6.550	*6.550	
		7,5 m	kg											
		6,0 m	kg	*2.350	*2.350			*2.550	*2.550					
		4,5 m	kg	*2.250	*2.250			*4.150	*4.150					
		3,0 m	kg	*2.250	*2.250			*4.700	4.300	*5.700	*5.700	*8.050	*8.050	
	3,0 m	1,5 m	kg	*2.350	*2.350			*5.050	4.200	*6.650	6.500	*10.050	*10.050	
		0,0 m	kg	*2.650	*2.650			*5.150	4.050	*7.050	6.300	*8.150	*8.150	
		-1,5 m	kg	*3.150	*3.150			*4.750	4.050	*6.700	6.200	*9.800	*9.800	*5.750 *5.750
		-3,0 m	kg	*3.600	*3.600					*5.250	*5.250	*7.550	*7.550	
		7,5 m	kg	*2.300	*2.300									
		6,0 m	kg	*2.000	*2.000			*3.300	*3.300					
	3,0 m	4,5 m	kg	*1.850	*1.850			*3.950	*3.950					
		3,0 m	kg	*1.850	*1.850	*3.050	3.000	*4.350	4.250	*5.150	*5.150			
		1,5 m	kg	*1.950	*1.950	*3.600	2.950	*4.750	4.150	*6.200	*6.200	*9.750	*9.750	
		0,0 m	kg	*2.100	*2.100	*3.350	2.900	*5.050	4.000	*6.850	6.200	*8.600	*8.600	
		-1,5 m	kg	*2.500	*2.500			*4.850	3.900	*6.750	6.100	*10.250	*10.250	*5.000 *5.000
		-3,0 m	kg	*3.300	*3.300			*3.850	*3.850	*5.700	*5.700	*8.400	*8.400	*8.050 *8.050

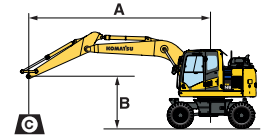

A – Reach from swing center

B – Bucket hook height

C – Lifting capacities, including bucket linkage (84 kg) and bucket cylinder (96 kg)

⊗ – Rating over rear/front

⊗ – Rating over side

⊗ – Rating at maximum reach



When removing linkage or cylinder, lifting capacities can be increased by their respective weights.

* Load is limited by hydraulic capacity rather than tipping. Ratings are based on ISO standard 10567. Rated loads do not exceed 87% of hydraulic lift capacity or 75% of tipping load.

 <p>Outrigger front + rear</p>	2,1 m	7,5 m	kg											
		6,0 m	kg	*2.850	*2.850									
		4,5 m	kg	*2.700	*2.700			*4.050	*4.050	*5.150	*5.150			
		3,0 m	kg	*2.700	*2.700			*4.850	*4.850	*6.050	*6.050	*8.850	*8.850	
		1,5 m	kg	*2.800	*2.800			*5.100	5.100	*6.800	*6.800			
		0,0 m	kg	*3.150	*3.150			*5.100	5.050	*7.050	*7.050	*7.700	*7.700	
	2,5 m	-1,5 m	kg	*3.900	*3.900			*4.450	*4.450	*6.400	*6.400	*9.200	*9.200	*6.350 *6.350
		-3,0 m	kg	*3.500	*3.500					*4.600	*4.600	*6.550	*6.550	
		7,5 m	kg											
		6,0 m	kg	*2.350	*2.350			*2.550	*2.550					
		4,5 m	kg	*2.250	*2.250			*4.150	*4.150					
		3,0 m	kg	*2.250	*2.250			*4.700	*4.700	*5.700	*5.700	*8.050	*8.050	
	3,0 m	1,5 m	kg	*2.350	*2.350			*5.050	*5.050	*6.650	*6.650	*10.050	*10.050	
		0,0 m	kg	*2.650	*2.650			*5.150	5.050	*7.050	*7.050	*8.150	*8.150	
		-1,5 m	kg	*3.150	*3.150			*4.750	*4.750	*6.700	*6.700	*9.800	*9.800	*5.750 *5.750
		-3,0 m	kg	*3.600	*3.600					*5.250	*5.250	*7.550	*7.550	
		7,5 m	kg	*2.300	*2.300									
		6,0 m	kg	*2.000	*2.000			*3.300	*3.300					
	3,0 m	4,5 m	kg	*1.850	*1.850			*3.950	*3.950					
		3,0 m	kg	*1.850	*1.850	*3.050	*3.050	*4.350	*4.350	*5.150	*5.150			
		1,5 m	kg	*1.950	*1.950	*3.600	*3.600	*4.750	*4.750	*6.200	*6.200	*9.750	*9.750	
		0,0 m	kg	*2.100	*2.100	*3.350	*3.350	*5.050	4.950	*6.850	*6.850	*8.600	*8.600	
		-1,5 m	kg	*2.500	*2.500			*4.850	*4.850	*6.750	*6.750	*10.250	*10.250	*5.000 *5.000
		-3,0 m	kg	*3.300	*3.300			*3.850	*3.850	*5.700	*5.700	*8.400	*8.400	*8.050 *8.050

Lifting Capacity

TWO-PIECE BOOM / undercarriage width 2,75 m

Arm length	A B	⊗		7,5 m		6,0 m		4,5 m		3,0 m		1,5 m			
		⊗	⊗	⊗	⊗	⊗	⊗	⊗	⊗	⊗	⊗	⊗	⊗		
 Without stabiliser	2,1 m	7,5 m kg	*3.550	*3.550					*3.750	*3.750					
		6,0 m kg	*2.900	2.400		3.000	2.400		*4.050	3.900					
		4,5 m kg	2.400	1.950		3.000	2.450		4.650	3.800					
		3,0 m kg	2.100	1.700		2.850	2.350		4.450	3.600					
		1,5 m kg	2.050	1.650		2.800	2.250		4.200	3.300					
		0,0 m kg	2.100	1.700		2.700	2.150		4.050	3.150					
		-1,5 m kg	2.350	1.900		2.700	2.150		4.000	3.150	7.650	5.750			
		-3,0 m kg													
		2,5 m	7,5 m kg	*2.850	*2.850					*3.950	*3.950				
	6,0 m kg		*2.400	2.150		3.050	2.500								
	4,5 m kg		2.200	1.800		3.000	2.500		4.750	3.900					
	3,0 m kg		1.950	1.600	2.100	1.650	2.900	2.400		4.500	3.650				
	1,5 m kg		1.900	1.550	2.000	1.650	2.800	2.250		4.200	3.350				
	0,0 m kg		1.950	1.550	1.950	1.600	2.700	2.150		4.050	3.200	*5.400	*5.400		
	-1,5 m kg		2.150	1.750			2.650	2.100		3.950	3.150	7.550	5.700		
	-3,0 m kg		2.750	2.250						4.000	3.150				
	3,0 m		7,5 m kg	*2.300	*2.300										
		6,0 m kg	*2.000	1.850		3.050	2.500								
4,5 m kg		1.900	1.500	2.050	1.650	3.000	2.450		*3.850	*3.850					
3,0 m kg		1.750	1.350	2.000	1.650	2.850	2.350		4.500	3.650					
1,5 m kg		1.650	1.350	1.950	1.550	2.750	2.200		4.200	3.350					
0,0 m kg		1.700	1.350	1.900	1.500	2.600	2.100		3.950	3.150	*5.700	5.600			
-1,5 m kg		1.850	1.500	1.900	1.500	2.550	2.050		3.850	3.000	7.350	5.550	*3.900	*3.900	
-3,0 m kg		2.200	1.800			2.550	2.050		3.850	3.000	7.400	5.550			
 Front or rear blade		2,1 m	7,5 m kg	*3.550	*3.550					*3.750	*3.750				
	6,0 m kg		*2.900	2.800		*3.100	2.850		*4.050	*4.000					
	4,5 m kg		*2.700	2.250		*4.150	2.850		*5.250	4.400					
	3,0 m kg		*2.700	2.000		*4.400	2.700		*5.900	4.200					
	1,5 m kg		*2.750	1.950		*4.750	2.650		*6.850	3.900					
	0,0 m kg		*3.050	2.000		*5.050	2.550		*6.900	3.750					
	-1,5 m kg		*3.550	2.250		*4.450	2.550		*6.200	3.750	*8.500	6.950			
	-3,0 m kg														
	2,5 m		7,5 m kg	*2.850	*2.850					*3.950	*3.950				
		6,0 m kg	*2.400	*2.400		*3.750	2.900								
		4,5 m kg	*2.300	2.100		*4.050	2.850		*5.000	4.500					
		3,0 m kg	*2.250	1.900	*3.350	1.950	*4.250	2.750		*5.650	4.250				
		1,5 m kg	*2.350	1.800	*3.650	1.950	*4.600	2.650		*6.650	3.950				
		0,0 m kg	*2.550	1.850	*3.400	1.900	*5.050	2.550		*6.950	3.750	*5.400	*5.400		
		-1,5 m kg	*2.950	2.050			*4.700	2.550		*6.450	3.750	*8.500	6.900		
		-3,0 m kg	*3.400	2.600						*5.050	3.750				
		3,0 m	7,5 m kg	*2.300	*2.300										
	6,0 m kg		*2.000	*2.000		*3.700	2.900								
4,5 m kg	*1.900		1.800	*3.000	1.950	*3.800	2.850		*3.850	*3.850					
3,0 m kg	*1.850		1.650	*3.250	1.950	*4.000	2.700		*5.250	4.250					
1,5 m kg	*1.900		1.600	*3.400	1.850	*4.350	2.600		*6.150	3.900					
0,0 m kg	*2.050		1.600	*3.650	1.800	*4.750	2.450		*6.800	3.700	*5.700	*5.650			
-1,5 m kg	*2.350		1.750	*3.300	1.800	*4.750	2.400		*6.550	3.600	*7.700	6.700	*3.900	*3.900	
-3,0 m kg	*2.800		2.100			*3.850	2.400		*5.500	3.600	*7.800	6.750			
 Rear outrigger	2,1 m		7,5 m kg	*3.550	*3.550					*3.750	*3.750				
		6,0 m kg	*2.900	*2.950		*3.100	*3.100		*4.050	*4.050					
		4,5 m kg	*2.700	*2.700		*4.150	3.550		*5.250	*5.250					
		3,0 m kg	*2.700	2.550		*4.400	3.450		*5.900	5.300					
		1,5 m kg	*2.750	2.450		*4.750	3.300		*6.850	5.000					
		0,0 m kg	*3.050	2.550		*5.050	3.250		*6.900	4.850					
		-1,5 m kg	*3.550	2.850		*4.450	3.200		*6.200	4.800	*8.500	*8.500			
		-3,0 m kg													
		2,5 m	7,5 m kg	*2.850	*2.850					*3.950	*3.950				
	6,0 m kg		*2.400	*2.400		*3.750	3.600								
	4,5 m kg		*2.300	*2.300		*4.050	3.600		*5.000	*5.000					
	3,0 m kg		*2.250	*2.250	*3.350	2.450	*4.250	3.450		*5.650	5.400				
	1,5 m kg		*2.350	2.250	*3.650	2.400	*4.600	3.350		*6.650	5.100				
	0,0 m kg		*2.550	2.350	*3.400	2.400	*5.050	3.250		*6.950	4.900	*5.400	*5.400		
	-1,5 m kg		*2.950	2.550			*4.700	3.200		*6.450	4.800	*8.500	*8.500		
	-3,0 m kg		*3.400	3.300						*5.050	4.850				
	3,0 m		7,5 m kg	*2.300	*2.300										
		6,0 m kg	*2.000	*2.000		*3.700	3.600								
4,5 m kg		*1.900	*1.900	*3.000	2.450	*3.800	3.550		*3.850	*3.850					
3,0 m kg		*1.850	*1.850	*3.250	2.400	*4.000	3.450		*5.250	*5.250					
1,5 m kg		*1.900	*1.950	*3.400	2.350	*4.350	3.300		*6.150	5.050					
0,0 m kg		*2.050	2.050	*3.650	2.300	*4.750	3.150		*6.800	4.800	*5.700	*5.700			
-1,5 m kg		*2.350	2.250	*3.300	2.250	*4.750	3.100		*6.550	4.700	*7.700	*7.700	*3.900	*3.900	
-3,0 m kg		*2.800	2.700			*3.850	3.100		*5.500	4.700	*7.800	*7.800			

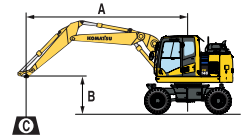

A – Reach from swing center

B – Bucket hook height

C – Lifting capacities, including bucket linkage (84 kg) and bucket cylinder (96 kg)

⊗ – Rating over rear/front

⊗ – Rating over side

⊗ – Rating at maximum reach

When removing linkage or cylinder, lifting capacities can be increased by their respective weights.

* Load is limited by hydraulic capacity rather than tipping. Ratings are based on ISO standard 10567. Rated loads do not exceed 87% of hydraulic lift capacity or 75% of tipping load.

PW148-11

Arm length	A	B	⊗		7,5 m		6,0 m		4,5 m		3,0 m		1,5 m			
			⊗	⊗	⊗	⊗	⊗	⊗	⊗	⊗	⊗	⊗	⊗			
			⊗	⊗	⊗	⊗	⊗	⊗	⊗	⊗	⊗	⊗	⊗			
 <p>Outrigger + blade</p>	2,1 m	7,5 m	kg	*3.550	*3.550				*3.750	*3.750						
		6,0 m	kg	*2.900	*2.900			*3.100	*3.100	*4.050	*4.050					
		4,5 m	kg	*2.700	*2.700			*4.150	*4.150	*5.250	*5.250					
		3,0 m	kg	*2.700	*2.700			*4.400	4.300	*5.900	*5.900					
		1,5 m	kg	*2.750	*2.750			*4.750	4.200	*6.850	6.450					
		0,0 m	kg	*3.050	*3.050			*5.050	4.050	*6.900	6.300					
			- 1,5 m	kg	*3.550	3.550			*4.450	4.050	*6.200	*6.200	*8.500	*8.500		
			- 3,0 m	kg												
		2,5 m	7,5 m	kg	*2.850	*2.850				*3.950	*3.950					
	6,0 m		kg	*2.400	*2.400			*3.750	*3.750							
	4,5 m		kg	*2.300	*2.300			*4.050	*4.050	*5.000	*5.000					
	3,0 m		kg	*2.250	*2.250	*3.350	3.050	*4.250	*4.250	*5.650	*5.650					
	1,5 m		kg	*2.350	*2.350	*3.650	3.000	*4.600	4.200	*6.650	6.500					
	0,0 m		kg	*2.550	*2.550	*3.400	3.000	*5.050	4.100	*6.950	6.300	*5.400	*5.400			
			- 1,5 m	kg	*2.950	*2.950			*4.700	4.050	*6.450	6.200	*8.500	*8.500		
			- 3,0 m	kg	*3.400	*3.400					*5.050	*5.050				
		3,0 m	7,5 m	kg	*2.300	*2.300										
	6,0 m		kg	*2.000	*2.000			*3.700	*3.700							
	4,5 m		kg	*1.900	*1.900	*3.000	*3.000	*3.800	*3.800	*3.850	*3.850					
	3,0 m		kg	*1.850	*1.850	*3.250	3.000	*4.000	*4.000	*5.250	*5.250					
	1,5 m		kg	*1.900	*1.900	*3.400	3.000	*4.350	4.150	*6.150	*6.150					
	0,0 m		kg	*2.050	*2.050	*3.650	2.900	*4.750	4.050	*6.800	6.200	*5.700	*5.700			
			- 1,5 m	kg	*2.350	*2.350	*3.300	2.900	*4.750	3.950	*6.550	6.100	*7.700	*7.700	*3.900	*3.900
			- 3,0 m	kg	*2.800	*2.800			*3.850	*3.850	*5.500	*5.500	*7.800	*7.800		

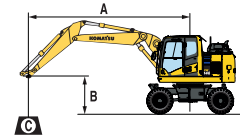

A – Reach from swing center

B – Bucket hook height

C – Lifting capacities, including bucket linkage (84 kg) and bucket cylinder (96 kg)

⊗ – Rating over rear/front

⊗ – Rating over side

⊗ – Rating at maximum reach

When removing linkage or cylinder, lifting capacities can be increased by their respective weights.

* Load is limited by hydraulic capacity rather than tipping. Ratings are based on ISO standard 10567. Rated loads do not exceed 87% of hydraulic lift capacity or 75% of tipping load.

 <p>Outrigger front + rear</p>	2,1 m	7,5 m	kg	*3.550	*3.550				*3.750	*3.750						
		6,0 m	kg	*2.900	*2.900			*3.100	*3.100	*4.050	*4.050					
		4,5 m	kg	*2.700	*2.700			*4.150	*4.150	*5.250	*5.250					
		3,0 m	kg	*2.700	*2.700			*4.400	*4.400	*5.900	*5.900					
		1,5 m	kg	*2.750	*2.750			*4.750	*4.750	*6.850	*6.850					
		0,0 m	kg	*3.050	*3.050			*5.050	*5.050	*6.900	*6.900					
			- 1,5 m	kg	*3.550	*3.550			*4.450	*4.450	*6.200	*6.200	*8.500	*8.500		
			- 3,0 m	kg												
		2,5 m	7,5 m	kg	*2.850	*2.850				*3.950	*3.950					
	6,0 m		kg	*2.400	*2.400			*3.750	*3.750							
	4,5 m		kg	*2.300	*2.300			*4.050	*4.050	*5.000	*5.000					
	3,0 m		kg	*2.250	*2.250	*3.350	*3.350	*4.250	*4.250	*5.650	*5.650					
	1,5 m		kg	*2.350	*2.350	*3.650	*3.650	*4.600	*4.600	*6.650	*6.650					
	0,0 m		kg	*2.550	*2.550	*3.400	*3.400	*5.050	*5.050	*6.950	*6.950	*5.400	*5.400			
			- 1,5 m	kg	*2.950	*2.950			*4.700	*4.700	*6.450	*6.450	*8.500	*8.500		
			- 3,0 m	kg	*3.400	*3.400					*5.050	*5.050				
		3,0 m	7,5 m	kg	*2.300	*2.300										
	6,0 m		kg	*2.000	*2.000			*3.700	*3.700							
	4,5 m		kg	*1.900	*1.900	*3.000	*3.000	*3.800	*3.800	*3.850	*3.850					
	3,0 m		kg	*1.850	*1.850	*3.250	*3.250	*4.000	*4.000	*5.250	*5.250					
	1,5 m		kg	*1.900	*1.900	*3.400	*3.400	*4.350	*4.350	*6.150	*6.150					
	0,0 m		kg	*2.050	*2.050	*3.650	3.600	*4.750	*4.750	*6.800	*6.800	*5.700	*5.700			
			- 1,5 m	kg	*2.350	*2.350	*3.300	*3.300	*4.750	*4.750	*6.550	*6.550	*7.700	*7.700	*3.900	*3.900
			- 3,0 m	kg	*2.800	*2.800			*3.850	*3.850	*5.500	*5.500	*7.800	*7.800		

Standard and Optional Equipment

ENGINE

Komatsu SAA4D107E-3 turbocharged common rail direct injection diesel engine	●
EU Stage IV compliant	●
Suction type cooling fan	●
Automatic engine warm-up system	●
Engine overheat prevention system	●
Auto-deceleration function	●
Adjustable idle shutdown	●
Engine ignition can be password secured on request	●
Batteries 2 × 12 V/125 Ah	●

HYDRAULIC SYSTEM

Electronic closed-centre load sensing (E-CLSS) hydraulic system (HydrauMind)	●
Pump and engine mutual control (PEMC) system	●
6-working mode selection system; Power, Lifting/ Fine Operation, Breaker, Economy, Attachment Power and Attachment Economy	●
PowerMax function	●
Adjustable PPC wrist control levers for arm, boom, bucket and swing, with sliding proportional control for attachments and 5 auxiliary buttons, with FNR switch	●
Additional hydraulic circuit (HCU-B)	●
Additional hydraulic circuit (HCU-C)	○
Extension HCU-C to HCU-D	○
Komatsu Integrated Attachment Control (KIAC)	○
Boom suspension system (ECSS)	○
Prepared for hydraulic quick-coupler	○

UNDERCARRIAGE

Parallel blade (front and/or rear) with cylinder protection	○
2 or 4 outriggers with cylinder protection, individually adjustable	○
Limited-slip differential (LSD)	○
Twin tyres 10.00-20 16 PR	○
Twin tyres Bandenmarkt Excavator 315/70 R22.5	○
Twin tyres Nokian 10-20 (L5)	○
Single tyres Michelin 18.00-19.5	○
Tyres Bandenmarkt Grader 315/70 R22.5	○
Trailer hitches	○
Fenders	○

CABIN

SpaceCab™; Highly pressurised and tightly sealed hyper viscous mounted cab with tinted safety glass windows, large roof window with sun shade, pull-up type front window with locking device, removable lower window, front window wiper with intermittent feature, sun roller blind, cigarette lighter, luggage shelf, floor mat	●
Heated air suspension seat with lumbar support, arm rests and retractable seat belt	●
Automatic climate control system	●
12/24 Volt power supplies	●
Beverage holder and magazine rack	●
Hot and cool box	●
Premium comfort seat	○
CD radio with auxiliary input (MP3 jack)	○
Heated, adjustable, suspended seat	○
Lower wiper	○
Rain visor (not with OPG)	○
Joystick steering system	○

SAFETY EQUIPMENT

KomVision surround view system	●
Electric horn	●
Overload warning device	●
Lockable fuel cap and covers	●
Audible travel alarm	●
Large handrails, rear-view mirrors	●
Battery main switch	●
Boom safety valves	●
Arm safety valve	●
Adjust cylinder safety valve	●
OPG Level II front guard (FOPS)	○
OPG Level II top guard (FOPS)	○
Audible travel alarm (white noise version)	○

LIGHTING SYSTEM

Standard halogen working lights package (4 front/4 rear)	●
Advanced halogen working lights package (8 front/4 rear)	○
LED working lights package (10 front/4 rear)	○
Beacon	○

SERVICE AND MAINTENANCE

Automatic fuel line de-aeration	●
Double element type air cleaner with dust indicator and auto dust evacuator	●
KOMTRAX – Komatsu wireless monitoring system (3G)	●
Multifunction video compatible colour monitor with Equipment Management and Monitoring System (EMMS) and efficiency guidance	●
Toolkit	●
Komatsu CARE™ – a maintenance program for Komatsu customers	●
Remote greasing bar	●
Automatic greasing system	○

DRIVES AND BRAKES

Fully automatic 3-speed transmission driving through front and rear planetary axles	●
Oscillating front axle (10°) with automatic and manual cylinder locking	●
Cruise control	●
2,55 m wide undercarriage	●
2,75 m wide undercarriage	○
20, 25 or 35 km/h speed limitation	○
Transmission guard	○

WORK EQUIPMENT

Mono boom	○
Two-piece boom	○
2,1 m; 2,5 m; 3,0 m arms	○
Clamshell grip bar	○
Lehnhoff quick-couplers	○
Lehnhoff buckets	○

OTHER EQUIPMENT

Standard counterweight	●
Electric refuelling pump with automatic shut-off function	●
Single chassis tool box	●
Additional chassis tool box	○
Biodegradable oil for hydraulic system	○
Customised paint	○

Further equipment on request

- standard equipment
- optional equipment

Your Komatsu partner:

KOMATSU

Komatsu Europe International N.V.
 Mechelsesteenweg 586
 B-1800 VILVOORDE (BELGIUM)
 Tel. +32-2-255 24 11
 Fax +32-2-252 19 81
www.komatsu.eu

VENSS06403 02/2021

KOMATSU is a trademark of Komatsu Ltd. Japan.

PW148-11