

# KOMATSU

## PC88MR-11



Midi-excavator

**Engine power**  
50.7 kW / 68.0 HP @ 1850 rpm

**Operating weight**  
8500 - 9130 kg

**Bucket capacity**  
0.09 - 0.34 m<sup>3</sup>

# High versatility, low fuel consumption and **safe performance in tight spaces**



## *Save time*

Productivity: +7% vs Dash 10



## *Save costs*

Reduced fuel consumption:  
-6% vs Dash 10



## *Increase versatility*

Attachment oil flow:  
+12% vs Dash 10



Engine power

**50.7 kW / 68.0 HP @ 1850 rpm**

Operating weight

**8500 - 9130 kg**

Bucket capacity

**0.09 - 0.34 m<sup>3</sup>**

## Powerful and environmentally friendly

- Low-consumption EU Stage V engine
- Integrated Diesel Particulate Filter (DPF) with 6000 SMR cleaning interval
- 6 selectable working modes
- Viscous engine fan clutch
- Komatsu fuel-saving technology

## Total versatility

- Excellent mobility in confined work spaces
- Standard hammer line
- Road-liner shoes (option)
- Lehnhoff Powertilt available as factory fit
- New, improved blade design

## First-class comfort

- Spacious and comfortable cab
- Proportional control on joystick for auxiliary circuits
- Multifunction monitor with high resolution 7" LCD color display
- Attachment changeover via monitor
- Sliding door for easy entry and exit

## Safety first

- LED working lights (standard)
- Rear- and side-view camera system
- Protrusion over tracks just 325 mm
- Neutral position detection system
- Secondary engine shutdown switch
- Seat belt caution indicator

## Easy maintenance

- Extended maintenance information displayed on the monitor
- Large access doors for maintenance
- Single side door for engine maintenance easily accessible from ground level
- Side-by-side coolers

## Komtrax

- Komatsu Wireless Monitoring System
- Integrated communication antenna
- 4G mobile communications
- Increased operational data and reports



## Powerful and environmentally friendly



### Performance and ecology

The EU Stage V engine is environmentally-friendly without the need of an SCR aftertreatment system. Combined with compact dimensions, this makes the PC88MR-11 a perfect choice for working in confined areas and on urban jobsites.

### High productivity and fuel saving

Depending on the load, operators can conveniently choose between 6 working modes designed to match engine speed, pump delivery and system pressure. Priority can be given either to speed, for more productivity, or to fuel consumption for lighter applications.

### Performance and controllability

The PC88MR-11 has a powerful swing force, can efficiently work on slopes, and delivers exceptional drawbar pull. In conjunction with automatic downshift, this machine is ideal on any terrain or for any application. The Closed Load Sensing System (CLSS) ensures unbeatable speed and control to all combined movements, no matter the load.

### High lift capacity

Along with its class leading compact size, the PC88MR-11 features an unrivalled lifting performance. The combination of power, convenient dimensions and complete control makes the PC88MR-11 the first choice for heavy-duty lifting applications or simple excavating tasks in narrow alleys, road construction sites and for sewer construction work.

## First-class comfort

### Increased comfort

In the wide Komatsu cab, a heated, high-back air-suspended seat, with fully adjustable armrests, is the centre of a comfortable and low-fatigue working environment. High visibility and ergonomic controls further assist to maximise the operator's productivity.

### Perfect operator convenience

Proportional controls are fitted as standard for safe and precise operation of attachments. The operator can connect his mobile device to the machine's Bluetooth® radio. A 12 Volt power port is also incorporated in the cab (option).

### Low-noise design

Komatsu crawler excavators have very low external noise levels and are especially well-suited for work in confined spaces or urban areas. The optimal usage of sound insulation and of sound absorbing materials helps to make noise levels inside the cab comparable to those of an executive car.



Convenient, ergonomic and precise control



Spacious and comfortable cab



Rear- and side-view camera system

## Total versatility



### Maximum flexibility

Thanks to auxiliary hydraulic lines, the PC88MR-11 can use a wide range of attachments. For breaking, crushing and all other applications, the optimal oil flow from the hydraulic pump can be selected directly on the LCD monitor. On the joystick, proportional controls for auxiliary circuits guarantee precision work with any tool. A wide range of options – such as road liners or a heavier counterweight – are available to let customers perfectly match the machine to their needs.

### Work in tight spaces

The short-tail PC88MR-11 delivers optimal power and digging speed, even in confined spaces where traditional machines can't work: yards, road works, demolition sites, sewers, etc. Sturdy and very stable, it guarantees maximum safety and offers complete operator confidence in any working conditions. Protrusion over tracks is just 325 mm. A reduced front swing radius and a left side swing cylinder make trench digging a cinch, and with its compact size the PC88MR-11 is perfect for urban or road-building jobsites.



### Powertilt option

Lehnhoff Powertilt is available as factory fit. It combines all benefits of a quick-coupler with a tilt motor, offering a huge work range of 2x 90° swivel range on both sides. Additional auxiliary lines allow the utilisation of complex attachments such as rotating grapples. Piping is routed over the arm for better protection and long lasting design. While Lehnhoff Powertilt is perfect for very precise bucket movements, it's also well suitable for breaker applications.

## Easy maintenance



### Excellent serviceability

Komatsu designed the PC88MR-11 with an easy access to all service points. Routine maintenance and servicing are less likely to be skipped, which can mean a reduction of costly downtime later on.

### Long-life oil filters

The Komatsu Genuine hydraulic oil filter uses high-performance filtering material for long replacement intervals, which significantly reduces maintenance costs.

### Easy access

The large doors and engine hood give convenient access to all daily service points. Filters are centralised and required service intervals are longer to keep machine downtime to a minimum. The radiator, aftercooler and oil cooler are made of aluminium to improve their efficiency and are mounted in parallel for quicker cleaning.

### Electric refuelling pump

Standard equipment on all PC88MR-11 includes an automatic shut-off fuelling pump that allows easy refuelling from a barrel.



All major maintenance points can be easily reached from ground level



Side-by-side radiator mounting for easy cleaning



Centralised arrangement of filters

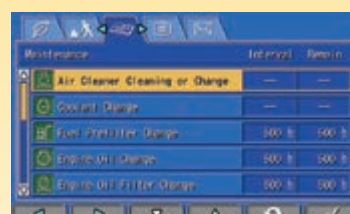

The LCD monitor informs about abnormalities and replacement times



**An evolutionary interface**

Helpful information is now easier than ever to find and understand with the upgraded monitor interface. An optimal main screen for the ongoing work can be selected simply by pressing the F3 key.

**Lower operating costs**

Komatsu ICT contributes to the reduction of operating costs by assisting to comfortably and efficiently manage operations. It raises the level of customer satisfaction and the competitive edge of our products.

**Widescreen monitor**

Installed with a choice of 26 languages, the widescreen monitor with simple switches and multifunction keys gives fingertip access to a large range of functions and operating info.

Equipped with universal piping for attachments such as breakers, the conversion to a low-pressure mode requires only a push of the breaker mode switch on the monitor.



Eco gauge, Eco guidance, an adjustable idle shutdown and a new auto idle function all contribute to further reduce fuel consumption

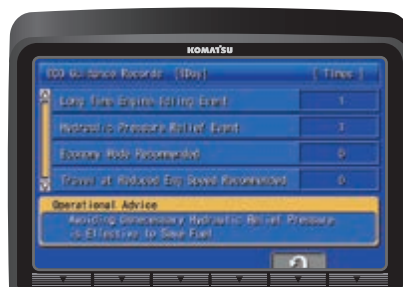

Eco guidance record

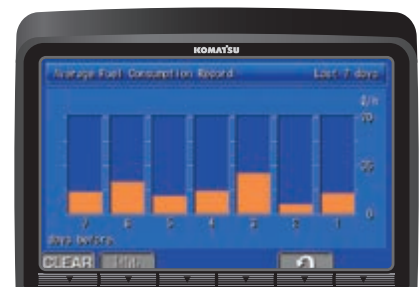

Fuel consumption history



## Information & communication technology



### Knowledge

You get quick answers to basic and critical questions about your machines – what they're doing, when they did it, where they're located, how they can be used more efficiently and when they need to be serviced. Performance data is relayed by wireless communication technology (satellite, GPRS or 4G depending on model) from the machine to a computer and to the local Komatsu distributor – who's readily available for expert analysis and feedback.

### Convenience

Komtrax enables convenient fleet management on the web, wherever you are. Data is analysed and packaged specifically for effortless and intuitive viewing in maps, lists, graphs and charts. You can foresee eventual maintenance issues and required spare parts, and troubleshoot a problem before Komatsu technicians arrive on site.



### The way to higher productivity

Komtrax uses the latest wireless monitoring technology. Compatible on PC, smartphone or tablet, it delivers insightful and cost saving information about your fleet and equipment, and offers a wealth of information to facilitate peak machine performance. By creating a tightly integrated web of support it allows proactive and preventive maintenance and helps to efficiently run a business.

### Power

The detailed information that Komtrax puts at your fingertips 24 hours a day, 7 days a week gives the power to make better daily and long-term strategic decisions – at no extra cost. Problems can be anticipated, maintenance schedules customised, downtime minimised and machines kept where they belong: working on the jobsite.



# Specifications

## Engine

Model	Komatsu SAA3D95E-1
Type	Common rail direct injection, water-cooled, emissionised, turbocharged, after-cooled diesel
Engine power	
at rated engine speed	1850 rpm
ISO 14396	50.7 kW / 68.0 HP
ISO 9249 (net engine power)	50.6 kW / 67.8 HP
No. of cylinders	3
Bore × stroke	95 × 115 mm
Displacement	2445 cm <sup>3</sup>
Max. torque / engine speed	337 Nm / 1440 rpm
Air filter type	Dry, double element type air cleaner with dust indicator and auto-dust evacuator
Fuel	Diesel fuel, conforming to EN590 Class 2/ Grade D. Paraffinic fuel capability (HVO, GTL, BTL), conforming to EN15940:2016

## Drives and brakes

Steering control	2 levers with pedals
Transmission	Hydrostatic
Hydraulic motors	Variable displacement, axial piston
Max. drawbar pull	67.2 kN (6950 kgf)
Max. travel speeds Lo / Hi	2.7 km/h - 5.0 km/h
Service brake	Hydraulic lock
Parking brake	Mechanical discs

## Undercarriage

Construction	X-frame centre section with box section track-frames
Type	Fully sealed
Track adjuster	Hydraulic
Shoes (each side)	39
Carrier rollers (each side)	1
Track rollers (each side)	5
Ground pressure	0.37 kg/cm <sup>2</sup>

## Blade

Width × height	2320 × 470 mm
Max. lifting above ground level	500 mm
Max. depth below ground level	440 mm

## Hydraulic system

Type	HydraMind. Closed-centre system with load sensing and pressure compensation valves
Main pumps	
Pump for	Boom, arm, bucket and travelling
Type	Variable displacement, axial piston
Max. flow	160 l/min
Pump for	Swing and blade
Type	Fixed displacement gear pump
Max. flow	70 l/min
Pump for	Pilot circuit
Type	Fixed displacement gear pump
Max. flow	12 l/min
Hydraulic motors	
Travel	2 × piston motor, variable displacement
Swing	1 × piston motor with swing holding brake
Relief valve setting	
Swing and blade	21.1 MPa (215 kg/cm <sup>2</sup> )
Travel and work equipment	26.5 MPa (270 kg/cm <sup>2</sup> )
Bucket breakout force (ISO 6015)	61.3 kN (6250 kgf)
Arm crowd force 1650 mm arm (ISO 6015)	41.5 kN (4230 kgf)

## Swing system

Driven by	Hydraulic motor
Swing reduction gear	Planetary gear
Swing circle lubrication	Grease-bathed
Swing brakes	Automatic, with oil immersed disks
Swing speed	10 rpm

## Service refill capacities

Fuel tank	125 l
Cooling system	17 l
Engine oil	10.5 l
Differential (each axle)	9 l
Gearbox	1.5 l
Swing drive	2.8 l

## Cab

Sound-proof cab, provided with safety glasses, liftable windscreen, roof window, sliding door with lock, windscreen-wiper, electric horn, adjustable seat with double slide, control system and instrumentation, adjustable joysticks, outside air inlet.

## Operating weight (appr.)

Shoes	Mono boom	Ground pressure	Two-piece boom
Steel (450 mm)	8580 kg	0.39 kg/cm <sup>2</sup>	8960 kg
Rubber (450 mm)	8500 kg	0.38 kg/cm <sup>2</sup>	8880 kg
Road liner (450 mm)	8720 kg	0.39 kg/cm <sup>2</sup>	9100 kg

Operating weight, including 1650 mm arm, 0.28 m<sup>3</sup> bucket (ISO 7451), operator, liquids, filled tank and standard equipment (ISO 6016).

## Environment

Engine emissions	Fully complies with EU Stage V exhaust emission regulations
Noise levels	
LwA external	98 dB(A) (2000/14/EC Stage II)
LpA operator ear	71 dB(A) (ISO 6396 dynamic test)
Vibration levels (EN 12096:1997)	
Hand/arm	≤ 2.5 m/s <sup>2</sup> (uncertainty K = 0.58 m/s <sup>2</sup> )
Body	≤ 0.5 m/s <sup>2</sup> (uncertainty K = 0.22 m/s <sup>2</sup> )
Contains fluorinated greenhouse gas HFC-134a (GWP 1430). Quantity of gas 0.7 kg; CO <sub>2</sub> equivalent 1.0 t	

## Machine dimensions

	Mono boom	Two-piece boom
A Transport length with 1650 mm arm	6255 mm	5820 mm
Transport length with 1900 mm arm	6380 mm	6110 mm
Transport length with 2100 mm arm	6430 mm	-
B Overall height (to top of boom)	2350 mm	2480 mm
C Overall width of upper structure	2330 mm	2330 mm
D Overall height of cab	2760 mm	2760 mm
E Clearance under counterweight	785 mm	785 mm
F Ground clearance	410 mm	410 mm
G Tail swing radius	1485 mm	1485 mm
H Tumbler centre distance	2235 mm	2235 mm
I Track length	2840 mm	2840 mm
J Track gauge	1870 mm	1870 mm
K Overall track width with 450 mm shoes	2320 mm	2320 mm
L Track shoe width	450 mm	450 mm
M Machine tail height (top of engine cover)	1885 mm	1885 mm
N Tail length	1485 mm	1485 mm

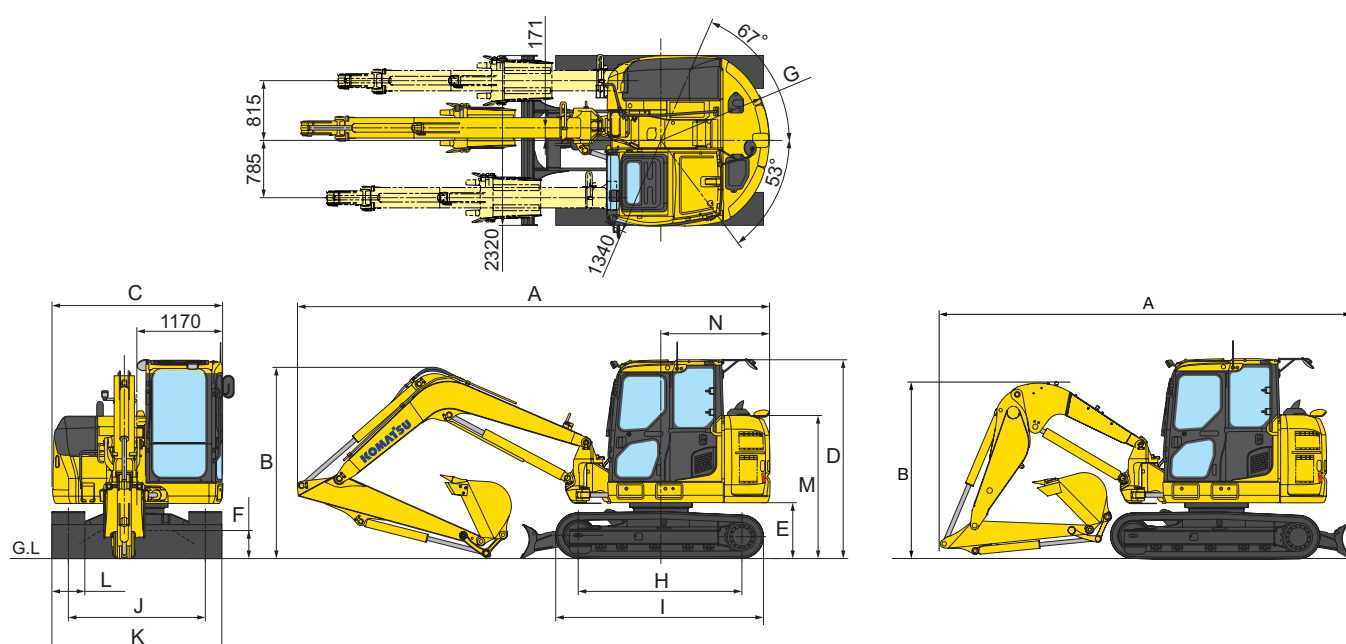

# Working range

## Mono boom

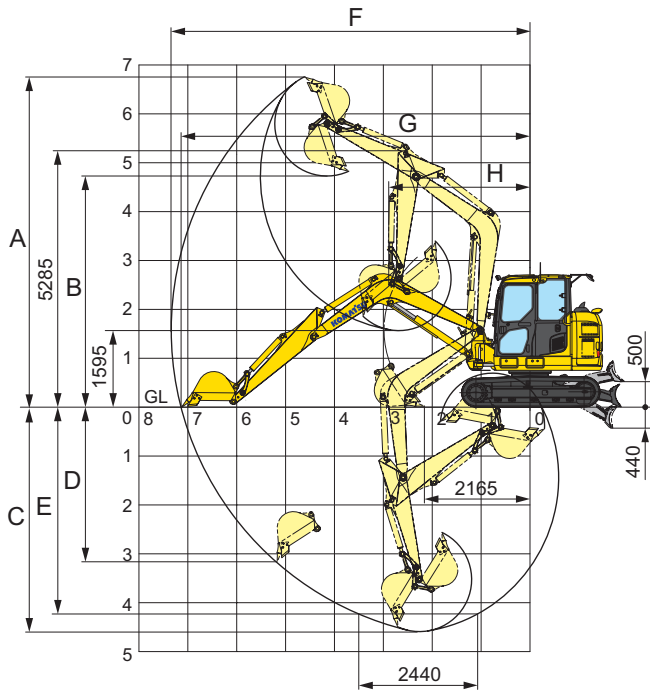

## Two-piece boom

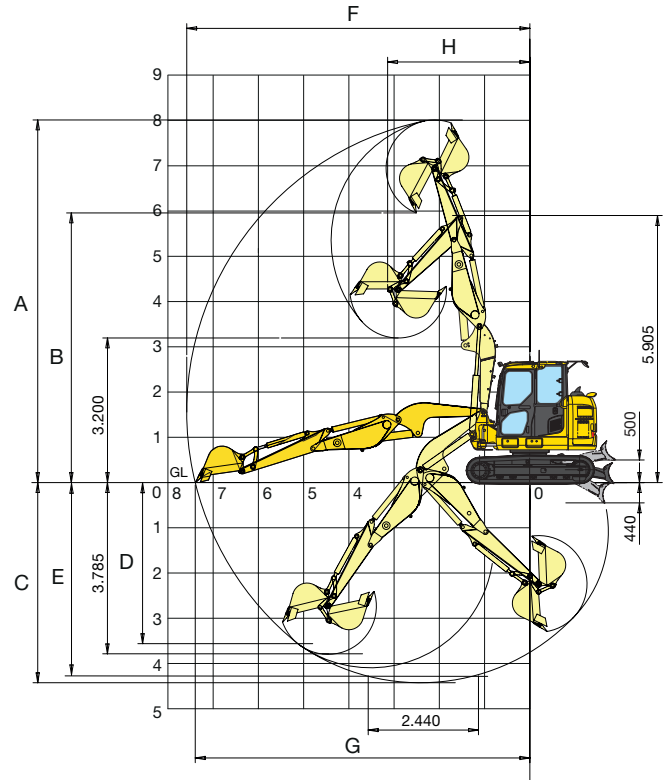

### Working range

	Mono boom			Two-piece boom	
	1650 mm	1900 mm	2100 mm	1650 mm	1900 mm
A Max. digging height	6570 mm	6660 mm	6750 mm	8020 mm	8260 mm
B Max. dumping height	4515 mm	4620 mm	4720 mm	5960 mm	6155 mm
C Max. digging depth	4160 mm	4400 mm	4615 mm	4425 mm	4675 mm
D Max. vertical wall digging depth	2900 mm	3065 mm	3165 mm	3785 mm	4020 mm
E Max. digging depth of cut for 2,44 m level	3765 mm	4025 mm	4250 mm	4265 mm	4525 mm
F Max. digging reach	6935 mm	7150 mm	7345 mm	7585 mm	7835 mm
G Max. digging reach at ground level	6725 mm	6950 mm	7150 mm	7400 mm	7655 mm
H Min. swing radius	2755 mm	2805 mm	2900 mm	3145 mm	3330 mm

### Bucket capacity (ISO 7451)

Bucket capacity	m <sup>3</sup>	0.107	0.171	0.181	0.235	0.282
Bucket width (with cutting edge)	mm	350	450	550	650	750

# Lifting capacity

A – Reach from swing center

 – Rating over front

B – Bucket hook height











 – Rating over side

Data and specifications are referring to the machine according to 89/392/CE and EN 474-5 directives.











When removing bucket, linkage or cylinder, lifting capacities can be increased by their respective weights.

Lifting capacities with 600 mm bucket (170 kg), 450 mm shoes, blade up, bucket linkage and bucket cylinder.











## Mono boom

B	A			5.5 m		4.5 m		3.0 m		2.0 m	
											
2100 mm	4.5 m	kg	1200	990	1210	990					
	3.0 m	kg	940	760	1190	970	*1420	1400			
	1.5 m	kg	850	680	1130	910	1580	1280	3070	2410	
	0.0 m	kg	870	690	1070	860	1470	1180	2800	2170	
	-1.5 m	kg	1040	830	1050	840	1430	1140	2770	2140	*3800 *3800
-3.0 m	kg	1730	1380					2850	2220	6530	4630
1900 mm	4.5 m	kg	1310	1070			*1360	*1360			
	3.0 m	kg	980	790	1160	940	1640	1340			
	1.5 m	kg	880	700	1110	890	1540	1240			
	0.0 m	kg	910	720	1060	850	1460	1160	2800	2170	
	-1.5 m	kg	1140	910			1440	1140	2810	2180	*4220 *4220
-3.0 m	kg	2410	180					2920	2270	*6610	4720
1650 mm	4.5 m	kg	1390	1150			*1400	*1400			
	3.0 m	kg	1060	870	1190	970	1680	1380			
	1.5 m	kg	960	780	1140	920	1580	1280			
	0.0 m	kg	990	800	1090	880	1500	1200	2850	2220	
	-1.5 m	kg	1220	990			1480	1180	2860	2230	*4620 *4620
-3.0 m	kg	2490	1970					2970	2320	*6710	4820











## Two-piece boom

B	A			5.5 m		4.5 m		3.0 m		2.0 m	
											
1900 mm	4.5 m	kg	900	690	1130	890	1690	1350			
	3.0 m	kg	700	520	1090	860	1570	1240			
	1.5 m	kg	640	470	1010	780	1400	1080			
	0.0 m	kg	680	500	960	730	1310	1000			
	-1.5 m	kg	840	630	970	740	1320	1000	2630	1960	*1810 *1810
-3.0 m	kg	*1070	*1070			*1290	1140	*2520	2140		
1650 mm	4.5 m	kg	980	770	1160	920	1730	1390			
	3.0 m	kg	780	600	1120	890	1610	1280			
	1.5 m	kg	720	550	1040	810	1440	1120			
	0.0 m	kg	760	580	990	760	1350	1040			
	-1.5 m	kg	920	710	1000	770	1360	1040	2680	2010	*2210 *2210
-3.0 m	kg	*1150	*1150			*1330	1180	*2570	2190		

## Mono boom + Powertilt (+ 205 kg)

B	A			5.5 m		4.5 m		3.0 m		2.0 m	
											
1900 mm	4.5 m	kg	1168	928			*1218	*1218			
	3.0 m	kg	838	648	1018	798	1498	1198			
	1.5 m	kg	738	558	968	748	1398	1098			
	0.0 m	kg	768	578	918	708	1318	1018	2658	2028	
	-1.5 m	kg	998	768			1298	998	2668	2038	*4078 *4078
-3.0 m	kg	2268	1748					2778	2128	*6468	4578
1650 mm	4.5 m	kg	1248	1008			*1258	*1258			
	3.0 m	kg	918	728	1048	828	1538	1238			
	1.5 m	kg	818	638	998	778	1438	1138			
	0.0 m	kg	848	658	948	738	1358	1058	2708	2078	
	-1.5 m	kg	1078	848			1338	1038	2718	2088	*4478 *4478
-3.0 m	kg	2348	1828					2828	2178	*6568	4678

## Two-piece boom + Powertilt (+ 205 kg)

B	A			5.5 m		4.5 m		3.0 m		2.0 m	
											
1900 mm	4.5 m	kg	758	548	988	748	1548	1208			
	3.0 m	kg	558	378	948	718	1428	1098			
	1.5 m	kg	498	328	868	638	1258	938			
	0.0 m	kg	538	358	818	588	1168	858			
	-1.5 m	kg	698	488	828	598	1178	858	2488	1818	*1668 *1668
-3.0 m	kg	*928	*928			*1148	998	*2378	1998		
1650 mm	4.5 m	kg	838	628	1018	778	1588	1248			
	3.0 m	kg	638	458	978	748	1468	1138			
	1.5 m	kg	578	408	898	668	1298	978			
	0.0 m	kg	618	438	848	618	1208	898			
	-1.5 m	kg	778	568	858	628	1218	898	2538	1868	*2068 *2068
-3.0 m	kg	1008	1008			*1188	1038	*2428	2048		

NOTE:  
 Ratings are based on ISO standard 10567. Rated loads do not exceed 87% of hydraulic lift capacity or 75% of tipping load. Excavators used in object handling operations must comply with the related local regulations and must be equipped with hose burst valves (boom & arm) and an overload warning device in compliance with EN474-5.

- The values marked with an asterisk (\*) are limited by the hydraulic capacities.
- Calculations are based on the machine resting on a uniform and firm surface.
- The lifting point is a hypothetical hook placed behind the bucket.

# Standard and optional equipment

## Engine

Komatsu SAA3D95E-1 turbocharged common rail direct injection diesel engine	●
EU Stage V compliant	●
Suction type cooling fan with radiator fly screen	●
Automatic engine warm-up system	●
Engine overheat prevention system	●
Fuel control dial	●
Auto-deceleration function	●
Adjustable idle shutdown	●
Engine key stop	●
Engine ignition can be password secured on request	●
Alternator 24 V / 60 A	●
Starter motor 24 V / 4.5 kW	●
Batteries 2 × 12 V / 75 Ah	●

## Hydraulic system

Electronic closed-centre load sensing (E-CLSS) hydraulic system (HydrauMind)	●
6-working mode selection system; power mode, economy mode, breaker mode, attachment power and attachment economy mode, and lifting mode	●
Adjustable PPC wrist control levers for arm, boom, bucket and swing, with sliding proportional control for attachments and 5 auxiliary buttons, with FNR switch	●
One additional 2-way full-flow service valve with hydraulic line for attachment on boom and arm (HCU-A)	●
Additional auxiliary hydraulic circuit (HCU-B)	●
Relieve valve on service spool	●
2nd auxiliary hydraulic circuit (HCU-C) + preparation for hydraulic quick-coupler	●
Additional hydraulic functions	○
Lehnhoff Powertilt	○
Lehnhoff quick-couplers	○

## Undercarriage

450 mm steel shoes	●
Track roller guard (not with rubber shoes)	●
450 mm road-liner shoes	○
450 mm rubber shoes	○

## Cabin

Large roof window, pull-up type front window with locking device, removable lower window, front window wiper with intermittent feature, cigarette lighter, floor mat	●
Heated, high-back air-suspended seat with lumbar support, arm rests and retractable seat belt	●
Control lever with FNR switch	●
Automatic climate control system	●
24 Volt power supply	●
Beverage holder	●
Radio with Bluetooth®	●
Rain visor	○
1 × 12 Volt power supply	○

## Service and maintenance

Automatic fuel line de-aeration	●
Double element type air cleaner with dust indicator and auto dust evacuator	●
Komtrax – Komatsu wireless monitoring system (4G)	●
Multifunction video compatible colour monitor with Equipment Management and Monitoring System (EMMS) and efficiency guidance	●
Toolkit	●

## Safety equipment

Rear- and side-view camera system	●
Electric horn	●
Overload warning device	●
Audible travel alarm	●
Boom safety valves	●
Large handrails, rear-view mirrors	●
Battery main switch	●
ROPS (ISO 12117) - OPG (ISO 10262) level 1	●
Secondary engine shutdown switch	●
Seat belt caution indicator	●
Neutral position detection system	●
Arm safety valve	●
Lateral mirror (right side)	●
OPG Level 2 top guard	○
Rotating beacon	○
Audible travel alarm (white noise version)	○

## LED lighting system

2 working lights on boom	●
4 front working lights on cab	●
Rear working light on cab	●

## Work equipment

Mono boom with cylinder protection	●
1650 mm arm	●
1900 mm arm	○
2100 mm arm (mono boom only)	○
Two-piece boom with cylinder protection	○
Bucket range (350 - 750 mm)	○
1500 mm ditch cleaning bucket	○
1650 mm ditch digging bucket (52°)	○
Bucket linkage with lifting hook	○

## Attachments

2320 mm blade	●
---------------	---

## Other equipment

Standard counterweight	●
Electric refuelling pump with automatic shut-off function	●
Biodegradable oil for hydraulic system	○
Customised paint	○

Further equipment on request

- standard equipment
- optional equipment



Rear- and side-view camera system (standard)



LED working lights (standard)



Additional auxiliary hydraulic circuits (option)



Lehnhoff Powertilt available as factory fit

A wide range of buckets and attachments is available. Your Komatsu distributor is ready to assist you with the selection of suitable options.

This specification sheet may contain attachments and optional equipment that are not available in your area. Please consult your local Komatsu distributor for those items you may require. Materials and specifications are subject to change without notice.

---

Your Komatsu partner:

**KOMATSU**

[komatsu.eu](https://www.komatsu.eu)

