

# KOMATSU

## PC17R-5 PC20R-5



Mini-excavator

**Engine power**  
11.8 kW / 15.8 HP @ 2600 rpm

**Operating weight**  
PC17R-5: 1755 - 1835 kg  
PC20R-5: 1985 - 2040 kg

**Bucket capacity**  
PC17R-5: 0.022 - 0.028 m<sup>3</sup>  
PC20R-5: 0.020 - 0.030 m<sup>3</sup>

High versatility, low fuel consumption and  
**safe performance in tight spaces**



Engine power

**11.8 kW / 15.8 HP @ 2600 rpm**

Operating weight

**PC17R-5: 1755 - 1835 kg**

**PC20R-5: 1985 - 2040 kg**

Transport weight

**PC17R-5: 1670 kg**

**PC20R-5: 1890 kg**

Bucket capacity

**PC17R-5: 0.022 - 0.028 m<sup>3</sup>**

**PC20R-5: 0.020 - 0.030 m<sup>3</sup>**





### Powerful and environmentally friendly

- Newly developed for the EU market
- Low-consumption EU Stage V engine
- Highest stability and lifting capacity thanks to new body and counterweight design
- Increased working capacity due to top-mounted boom cylinder (PC20R-5)

### First-class comfort

- Newly designed cab
- Grammer adjustable suspension seat (option)
- Improved operator convenience
- Low vibration levels with short pitch rubber shoes

### Safety first

- Dual lock system for PPC controls
- Secondary engine shutdown switch
- Seat belt caution indicator
- Lifting eyes on cabin roof and tie down points on upper structure
- LED working lights (option)

### Total versatility

- Designed for easy transportation on 2.5 tonnes GVW trailer (PC17R-5)
- Lehnhoff Powertilt available as factory fit (PC20R-5)
- 3rd auxiliary circuit for hydraulic powertilt and 4th line for hydraulic quick-coupler single effect (PC20R-5) (option)
- Hydraulic quick coupler line (PC20R-5) (option)
- Proportional control for attachments (option)
- Variable gauge undercarriage as standard

### Easy maintenance

- Improved filtration
- Easy maintenance access direct from ground level
- Fully opening engine door and side cover

### Komtrax (option)

- Komatsu Wireless Monitoring System
- 4G mobile communications
- Increased operational data and reports

## Powerful and environmentally friendly



### **Komatsu EU Stage V**

The Komatsu EU Stage V engine is productive, dependable and efficient. With ultra-low emissions, it provides a lower environmental impact and a superior performance to help reduce operating costs and lets the operator work in complete peace of mind.

### **Komatsu CLSS**

The CLSS (Closed-centre Load Sensing System) hydraulic circuit guarantees power, speed and perfect control to all movements, including simultaneous ones. The combination of the variable displacement pump and of CLSS allows operators to perform all required movements with maximum efficiency, regardless of the load or rpm.

### **Highest stability and digging force**

The conventional tail concept delivers highest stability and lifting capacity for both models. In addition, on the PC20R-5 the boom cylinder is mounted top side and the orientation is reversed. This further improves the digging force, and eliminates risk of cylinder rod damage when loading.

## Total versatility



Tie down points on upper structure help to quickly secure the machine for transport



Fast and simple lifting using ropes only, without any additional tools required



Perfect control even during combined operations

## Easy to transport

The PC17R-5 has been developed specifically to combine high performance with very easy transportation. Thanks to its convenient weight, it can be moved together with two standard-sized buckets on a small 2.5 tonnes trailer, with a simple car driver's licence. No truck is required to easily transport the machine to a jobsite, and back to the yard.



Foldable blade to match the variable undercarriage gauge

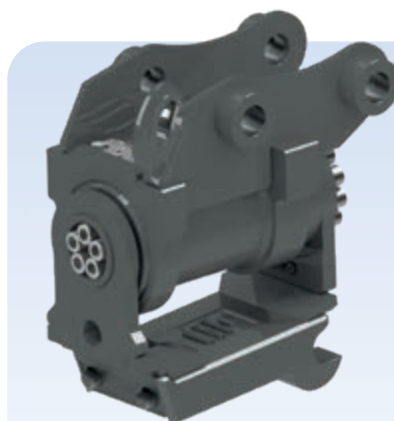

### Powertilt option (PC20R-5)

Lehnhoff Powertilt is available as factory fit. It combines all benefits of a quick-coupler with a tilt motor, offering a huge work range of 2x 90° swivel range on both sides. Additional auxiliary lines allow the utilisation of complex attachments such as rotating grapples. Piping is routed over the arm for better protection and long lasting design. While Lehnhoff Powertilt is perfect for very precise bucket movements, it's also well suitable for breaker applications.

## First-class comfort



### An optimal work environment

Developed with an exceptional care to details, Komatsu's new high comfort spacious cab offers a quiet and comfortable work environment. Special attention was given to the operator, with unrivalled foot space in this class, ergonomic and dedicated PPC controls, and an efficient ventilation system. The wide cab door and conveniently located hand grips make access safe and easy.

### Perfect operator convenience

A 1/2 way auxiliary hydraulic circuit allows the usage of multiple working tools, such as a hammer, a clamshell bucket, an auger, etc. Proportional controls are available, in option, for the safe and precise operation of attachments. The automatic travel speed shift function allows smooth and efficient operation. You can choose auto 2-speed or fixed 1st speed travel for easy shifting during blade operation by pressing the speed selector button on the blade lever. A 12 Volt power port is also included in the cab.



## Information & communication technology



### Knowledge

You get quick answers to basic and critical questions about your machines – what they're doing, when they did it, where they're located, how they can be used more efficiently and when they need to be serviced. Performance data is relayed by wireless communication technology (satellite, GPRS or 4G depending on model) from the machine to a computer and to the local Komatsu distributor – who's readily available for expert analysis and feedback.

### Convenience

Komtrax enables convenient fleet management on the web, wherever you are. Data is analysed and packaged specifically for effortless and intuitive viewing in maps, lists, graphs and charts. You can foresee eventual maintenance issues and required spare parts, and troubleshoot a problem before Komatsu technicians arrive on site.



### The way to higher productivity

Komtrax uses the latest wireless monitoring technology. Compatible on PC, smartphone or tablet, it delivers insightful and cost saving information about your fleet and equipment, and offers a wealth of information to facilitate peak machine performance. By creating a tightly integrated web of support it allows proactive and preventive maintenance and helps to efficiently run a business.

### Power

The detailed information that Komtrax puts at your fingertips 24 hours a day, 7 days a week gives the power to make better daily and long-term strategic decisions – at no extra cost. Problems can be anticipated, maintenance schedules customised, downtime minimised and machines kept where they belong: working on the jobsite.



## Easy maintenance



### Excellent serviceability

Just open two doors for a quick access to daily inspection points and the side-by-side coolers. For major service tasks, the cab floor cover is easily removable, offering convenient access directly from ground level. The fuel filler is located low for refueling in a safe and easy-to-reach position. A large fuel filter and fuel pre-filter with water separator protect the engine. High durability bushings and a 500 hours engine oil change interval further lower operating costs.





## Highest reliability and safety

### Optimal jobsite safety

For increased jobsite safety, the PC17/20R-5 includes a dual lock lever neutral detection system for travel and work equipment levers, along with a seat belt caution indicator and a secondary engine shutdown switch.

### Variable undercarriage

For applications requiring maximum versatility in terms of size and stability, the PC17/20R-5 offers hydraulic undercarriage extension, which is operated from the operator's seat via a push button and the blade control lever.

This feature allows the operator to quickly switch from maximum stability for working to a reduced width of less than one metre for driving through narrow passages or doors.



Secondary engine shutdown switch



Seat belt caution indicator on the dashboard



Large glass surfaces provide an excellent all-round view on the job site

# Specifications

## Engine

Model	Komatsu 3D67E-2
Type	Swirl chamber
Engine power	
at rated engine speed	2600 rpm
ISO 14396	11.8 kW / 15.8 HP
ISO 9249 (net engine power)	11.4 kW / 15.3 HP
No. of cylinders	3
Bore × stroke	67 × 74 mm
Displacement	778 cm <sup>3</sup>
Max. torque / engine speed	44.1 Nm / 1800 rpm
Cooling system	Water
Air filter type	Dry
Starter motor	Electric motor with pre-heating air system for cold climate
Fuel	Diesel fuel, conforming to EN590 Class 2/Grade D. Paraffinic fuel capability (HVO, GTL, BTL), conforming to EN 15940:2016

## Drives and brakes

Type	2 levers with pedals giving full independent control of each track
Drive method	Hydrostatic
Hydraulic motors	2 × axial piston
Reduction system	Planetary gear
Max. travel speeds (Lo / Hi)	2.2 - 4.2 km/h
Maximum drawbar pull	
PC17R-5	12.9 kN (1316 kgf)
PC20R-5	14.9 kN (1520 kgf)

## Undercarriage

Construction	Variable gauge with centre sliding section
Track rollers (each side)	3
Shoe width	230 mm
Ground pressure (standard)	
PC17R-5	0.316 kg/cm <sup>2</sup>
PC20R-5	0.34 kg/cm <sup>2</sup>

## Hydraulic system

Type	Komatsu CLSS
Main pumps	1 × variable displacement pump 1 × gear pump
Max. pump flow	36 l/min
Max. operating pressure	
PC17R-5	18.5 MPa (185 bar)
PC20R-5	21.0 MPa (210 bar)
Hydraulic motors	
Travel	2 × variable displacement motor
Swing	1 × fixed displacement motor
Hydraulic cylinders (bore × stroke) PC17R-5	
Boom	65 × 365 mm
Arm	50 × 453 mm
Bucket	50 × 378 mm
Boom swing	60 × 310 mm
Blade	65 × 100 mm
Hydraulic cylinders (bore × stroke) PC20R-5	
Boom	65 × 475 mm
Arm	55 × 447 mm
Bucket	50 × 378 mm
Boom swing	60 × 292 mm
Blade	65 × 100 mm
Bucket digging force	
PC17R-5	990 kg
PC20R-5	1130 kg
Arm crowd force PC17R-5	
880 mm arm	630 kg
Arm crowd force PC20R-5	
1215 mm arm	890 kg

## Service refill capacities

Fuel tank	19 l
Cooling system	4.2 l
Engine oil	3.6 l
Hydraulic system	23.8 l

## Blade

Type	Central welded steel structure with extendable side sections
<b>PC17R-5</b>	
Width × height	1280 (990) × 240 mm
Blade, max. lifting height	180 mm
Blade, max. digging depth	225 mm
<b>PC20R-5</b>	
Width × height	1280 (990) × 250 mm
Blade, max. lifting height	230 mm
Blade, max. digging depth	300 mm

## Swing system

The rotation is operated by means of an orbital hydraulic motor. Single ball-bearing ring with internal, induction hardened tooth ring. Centralised lubrication of the unit.

Swing speed	9.0 rpm
-------------	---------

## Machine dimensions

		PC17R-5	PC20R-5
A Overall length	mm	3800	3845
B Overall height	mm	2370	2370
C Track length	mm	1450	1570
D Track gauge (min)	mm	990	990
E Track gauge (max)	mm	1280	1280
F Shoe width	mm	230	230
G Tail swing radius	mm	1120	1120
H/I Boom swing angle	°	74 / 45	74 / 45
J Boom offset LH	mm	310	310
K Boom offset RH	mm	560	560

## Operating weight (appr.)

	PC17R-5	PC20R-5
Rubber shoes	1755 kg	1985 kg
Steel shoes	1835 kg	2040 kg

Operating weight, including cab, standard bucket, operator, liquids, filled tank and standard equipment (ISO 6016).

## Environment

Engine emissions	Fully complies with EU Stage V exhaust emission regulations
Noise levels	
LwA external	93 dB(A) (2000/14/EC Stage II)
LpA operator ear	78 dB(A) (ISO 6396 dynamic test)
Vibration levels (EN 12096:1997)	
Hand/arm	≤ 2.5 m/s <sup>2</sup> (uncertainty K = 1.2 m/s <sup>2</sup> )
Body	≤ 0.5 m/s <sup>2</sup> (uncertainty K = 0.2 m/s <sup>2</sup> )

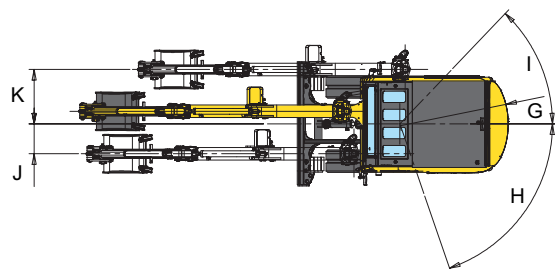
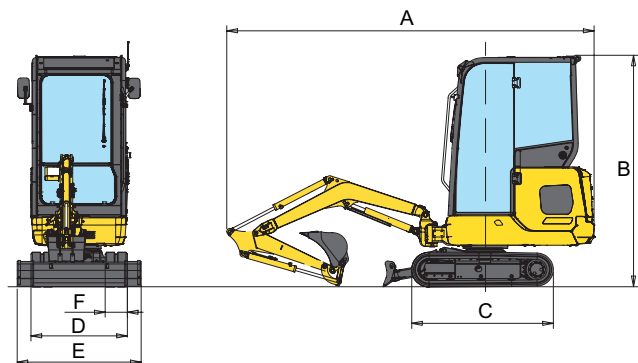

## Working range

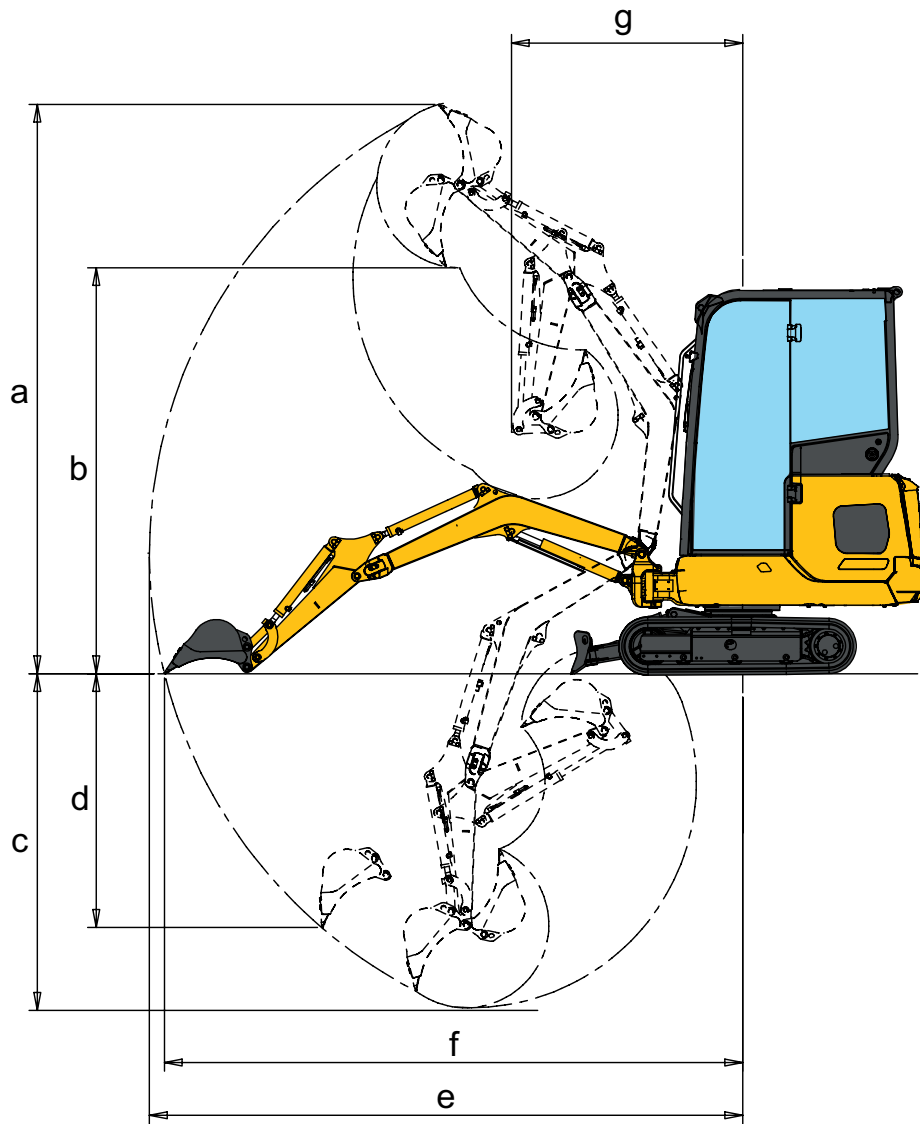

Working range		PC17R-5		PC20R-5	
Arm length	mm	880	1130	965	1215
a Max. digging height	mm	3370	3670	3570	3800
b Max. dumping height	mm	2450	2660	2560	2760
c Max. digging depth	mm	2000	2200	2100	2370
d Max. vertical wall digging depth	mm	1500	1740	1685	1980
e Max. digging reach	mm	3630	3890	3830	4100
f Max. digging reach at ground level	mm	3540	3800	3760	4030
g Min. swing radius	mm	1425	1560	1415	1515

# Lifting capacity

**A** Reach from swing centre





**B** Bucket hook height

Lifting capacities, including bucket, bucket linkage and bucket cylinder





 Rating over front

 Rating over side





## PC17R-5 over front, blade up

Arm length	A	1.0 m	2.0 m	3.0 m	Max.
	B				
880 mm	2.0 m kg		275		260
	1.0 m kg		440	275	265
	0.0 m kg		520	285	285
	-1.0 m kg	905	405		295
1130 mm	0.0 m kg		510	280	255





## PC17R-5 over front, blade down

Arm length	A	1.0 m	2.0 m	3.0 m	Max.
	B				
880 mm	2.0 m kg		275		260
	1.0 m kg		440	275	265
	0.0 m kg		525	285	285
	-1.0 m kg	905	405		295
1130 mm	0.0 m kg		510	280	255





## PC20R-5 over front, blade up

Arm length	A	1.0 m	2.0 m	3.0 m	Max.
	B				
965 mm	3.0 m kg				330
	2.0 m kg		295		335
	1.0 m kg		605	345	300
	0.0 m kg		610	320	280
	-1.0 m kg	1280	425		250
1215 mm	0.0 m kg		635	330	260





## PC20R-5 over front, blade down

Arm length	A	1.0 m	2.0 m	3.0 m	Max.
	B				
965 mm	3.0 m kg				330
	2.0 m kg		295		335
	1.0 m kg		605	345	300
	0.0 m kg		610	320	280
	-1.0 m kg	1280	425		250
1215 mm	0.0 m kg		635	330	260

## PC20R-5 over front, blade up, Powertilt

Arm length	A	1.0 m	2.0 m	3.0 m	Max.
	B				
965 mm	3.0 m kg				270
	2.0 m kg		255		285
	1.0 m kg		565	300	250
	0.0 m kg		565	275	230
	-1.0 m kg	1225	385		205

## PC20R-5 over front, blade down, Powertilt

Arm length	A	1.0 m	2.0 m	3.0 m	Max.
	B				
965 mm	3.0 m kg				270
	2.0 m kg		255		285
	1.0 m kg		565	300	250
	0.0 m kg		565	275	230
	-1.0 m kg	1225	385		205

Ratings are based on ISO standard 10567. Rated loads do not exceed 87% of hydraulic lift capacity or 75% of tipping load. Excavators used in object handling operations must comply with the related local regulations and must be equipped with hose burst valves (boom & arm) and an overload warning device in compliance with EN474-5.

- The values marked with an asterisk (\*) are limited by the hydraulic capacities.
- Calculations are based on the machine resting on a uniform and firm surface.
- The lifting point is a hypothetical hook placed behind the bucket.

## Standard and optional equipment

### Engine

Komatsu 3D67E-2 diesel engine	●
EU Stage V compliant	●
Automatic two-speed travel control	●
Alternator 12 V / 40 A	●
Starter motor 12 V / 1.4 kW	●
Batteries 12 V / 45 Ah	●

### Hydraulic system

Komatsu closed-centre load sensing (CLSS) hydraulic system	●
PPC control lever and pedals for steering and travel	●
Adjustable PPC wrist control levers for arm, boom, bucket and swing	●
Hydraulic line for hammer and for 2-way equipment up to boom and arm (HCU-A)	●
Proportional controls for attachment on joystick	○
Hydraulic quick-coupler line	○
3rd auxiliary circuit for hydraulic powertilt and 4th line for hydraulic quick-coupler single effect (PC20R-5)	○
Lehnhoff Powertilt (PC20R-5)	○
Lehnhoff quick-couplers	○

### Undercarriage

230 mm rubber shoes	●
230 mm steel shoes	○

### Cabin

ROPS (ISO 3471) / OPG (ISO 10262) level 1 cab with heating, skylight, pull-up type front window with locking device, lower window, windscreen-wiper, floor mat	●
Adjustable suspension seat with seat belt	●
12 Volt power supply	●
Beverage holder	●
Radio	○
Adjustable deluxe suspension seat with retractable seat belt (Grammer)	○

### Service and maintenance

Automatic fuel line de-aeration	●
Double element type air cleaner with dust indicator and auto dust evacuator	●
Toolkit	●
Komtrax – Komatsu wireless monitoring system (4G)	○

### Safety equipment

Electric horn	●
Audible travel alarm	●
Lifting cylinder guard	●
Rear-view mirrors	●
Battery main switch	●
ROPS (ISO 12117) - OPG (ISO 10262) level 1	●
Secondary engine shutdown switch	●
Seat belt caution indicator	●
Dual lock system for PPC controls	●
Rotating beacon	○

## Lighting system

Working light on boom, 2 front working lights on cab	●
LED lighting system: Working light on boom, 2 front working lights on cab, rear working light on cab	○

## Work equipment

Blade	●
880 mm arm (PC17R-5)	●
965 mm arm (PC20R-5)	●
1130 mm arm (PC17R-5)	○
1215 mm arm (PC20R-5)	○
Bucket range (250 - 450 mm)	○
1000 mm ditch cleaning bucket	○

## Other equipment

Standard counterweight	●
Change-over valve on bucket cylinder for clamshell bucket utilization (PC20MR-5)	○
Biodegradable oil for hydraulic system	○
Customised paint	○
Tie down points (rear)	○

Further equipment on request

- standard equipment
- optional equipment



A wide range of buckets and attachments is available. Your Komatsu distributor is ready to assist you with the selection of suitable options.

This specification sheet may contain attachments and optional equipment that are not available in your area. Please consult your local Komatsu distributor for those items you may require.

Materials and specifications are subject to change without notice.

---

Your Komatsu partner:

**KOMATSU**

[komatsu.eu](https://www.komatsu.eu)

