

# KOMATSU

## PW168-11



Hydraulic wheeled excavator

**Engine power**  
110 kW / 148 HP @ 2000 rpm

**Operating weight**  
15775 - 18115 kg

**Bucket capacity**  
max. 1.13 m<sup>3</sup>



**Short tail swing**

Reduced tail swing: -345 mm vs standard tail model



**Save costs**

Reduced fuel consumption: -5% vs previous model



Engine power  
**110 kW / 148 HP @ 2000 rpm**

Operating weight  
**15775 - 18115 kg**

Bucket capacity  
**max. 1.13 m<sup>3</sup>**

# High versatility, low transportation height and safe performance in tight spaces

## Powerful and environmentally friendly

- EU Stage V engine
- Adjustable idle shutdown
- 8000 h KDPF cleaning interval
- Excellent travel performance
- High lifting capacity
- HVO diesel fuel ready



## Total versatility

- Ideal for a wide range of applications
- Additional hydraulic circuit
- Komatsu Integrated Attachment Control (KIAC) (option)
- A wide choice of options
- Factory-equipped for tiltrotator use
- Prepared for 3D aftermarket systems

## First-class operator comfort

- Premium air-suspended operator seat with integrated joystick consoles (option)
- Boom suspension system (ECSS) (option)
- Low noise level inside and outside
- Joystick steering system (option)
- Automatic digging brake (option)

## Safety first

- Compact design with short tail swing radius
- KomVision surround view system
- LED lighting standard
- Safe access to cab and maintenance

## Easy maintenance

- Ground level service access
- Centralised greasing system
- User-friendly location of the electric refuelling pump
- Simple access to the AdBlue® tank
- Komatsu Care included

## Digital assistance & guidance

- Komtrax – Komatsu wireless monitoring system
- Smart Construction 3D Machine Guidance (option)



### Higher productivity

Along with its compact size, the PW168-11 features an unrivalled lifting performance. The combination of power, weight distribution, convenient dimensions and complete control makes it the top choice for heavy-duty lifting applications, simple excavating tasks in narrow alleys, and for road and sewer construction sites.

### Komatsu fuel-saving technology

Engine management is enhanced. The variable speed matching of the engine and hydraulic pumps guarantee efficiency and precision during single and combined movements. A viscous clutch enables variable cooling fan speed to further reduce fuel consumption.

### Adjustable idle shutdown

The Komatsu auto idle shutdown automatically turns off the engine after it idles for a set period of time. This feature can easily be programmed from 5 to 60 minutes, to reduce unnecessary fuel consumption and exhaust emissions, and to lower operating costs. An Eco-gauge and the Eco guidance tips on the cab monitor further encourage efficient operations.

## Powerful and environmentally friendly

### Komatsu EU Stage V

The Komatsu EU Stage V engine is productive, dependable and efficient. With ultra-low emissions, it provides a lower environmental impact and a superior performance to help reduce operating costs and lets the operator work in complete peace of mind.

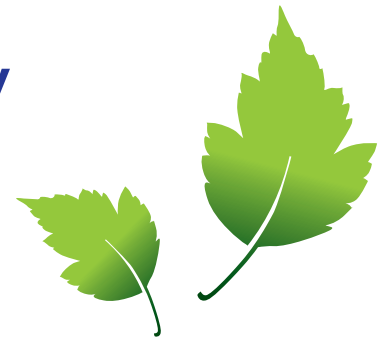

### Heavy-duty aftertreatment

The aftertreatment system combines a Komatsu Diesel Particulate Filter (KDPF) and Selective Catalytic Reduction (SCR). The SCR injects the correct amount of AdBlue® into the system at the proper rate to break down NOx into water (H<sub>2</sub>O) and non-toxic nitrogen gas (N<sub>2</sub>).

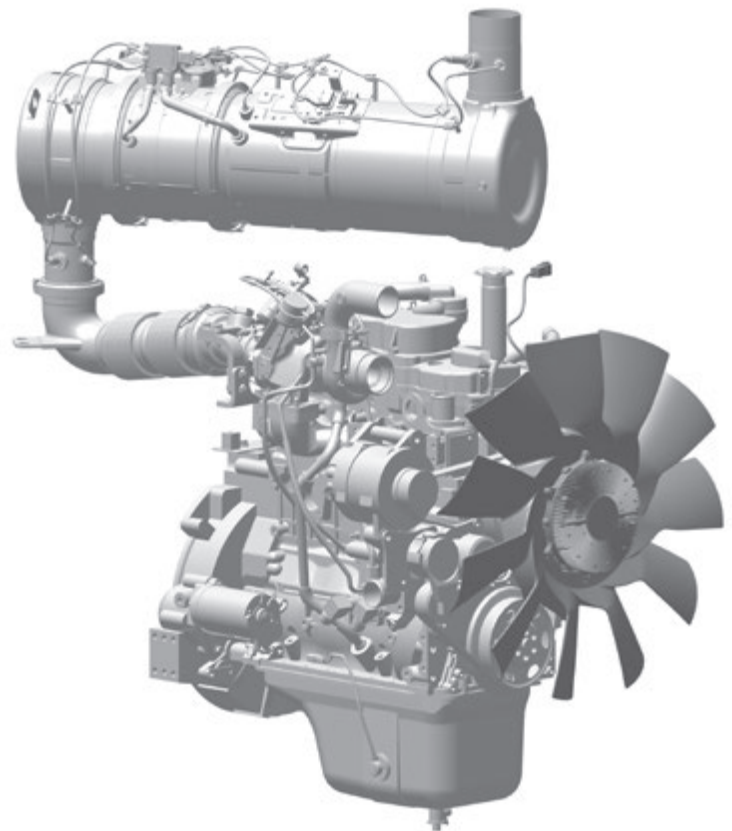

### HVO diesel fuel ready



Committed to reducing CO<sub>2</sub> emissions, Komatsu diesel engines are compatible with paraffinic fuels (HVO, GTL, BTL) as per EN 15940:2016. All new wheeled excavators come with an initial fill of HVO diesel directly from the factory.



Eco-gauge, Eco guidance and fuel consumption gauge



ECO guidance record



Fuel consumption history

## PW168-11

### **Ideal for a wide range of applications**

Powerful and precise, the Komatsu PW168-11 is equipped to efficiently carry out any task your business requires. On big sites or small, for digging, trenching, landscaping or site preparation, the Komatsu original equipment hydraulic system always ensures maximum productivity and control.

### **Additional hydraulic circuit**

To allow the use of many attachments, such as buckets, breakers or clamshell buckets, an additional hydraulic circuit controlled by a sliding joystick button is standard on the PW168-11. To further increase versatility and flexibility, a second optional auxiliary circuit and an optional hydraulic quick-coupler actuation are also available. In combination with the Komatsu Integrated Attachment Control (KIAC), changing and operating different attachments becomes child's play.

### **Boom suspension system (ECSS)**

An optional electrical controlled suspension system (ECSS) for the boom provides a significant increase in comfort when traveling over bumps.



**Total versatility**





### Tiltrotator preparation

The PW168-11 comes factory-equipped as standard for use with a tiltrotator. With an open system design, the machine can be made even more productive and easily fitted with a tiltrotator of your choice. Tools with high hydraulic flow demands can be used simultaneously with a tiltrotator and full hydraulic quick couplers, thanks to the powerful second auxiliary circuit.

### Komatsu Integrated Attachment Control (KIAC) (option)

For fast and safe tool changes without leaving the cab, the settings for oil flow and pressure of up to 15 hydraulic attachments are available as presets directly on the monitor panel. Komatsu Integrated Attachment Control (KIAC) includes adjustments for the first and second (optional) hydraulic circuits. Selecting the breaker mode automatically cuts all pressure in the return line.



Komatsu Integrated Attachment Control (KIAC)



Adjustable oil flow

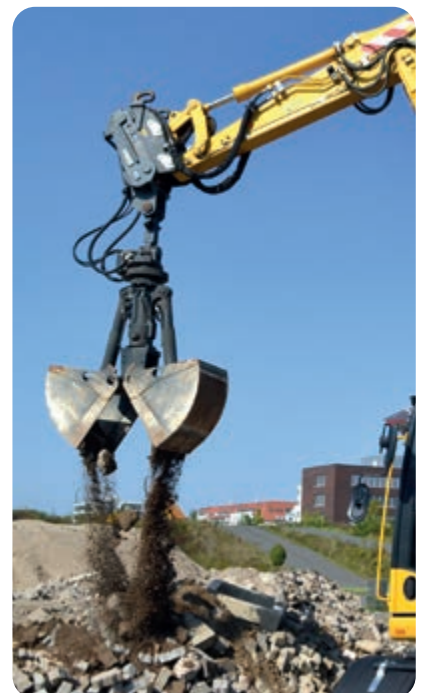



## Total versatility



### Standard or wide axles

No matter the job, with a small turning radius and excellent traction the axles are built for a maximum performance. For even better stability a 2750 mm wide axle is available. If more traction is needed, an optional 35% differential lock helps to get over rough terrain. To keep the machine cleaner, robust fenders are also available as option.

### Trailer hitch

For increased versatility, the PW168-11 can be equipped with either a ball type hitch or a truck type automatic hitch, for trailers up to 7.5 tonnes with an overrun brake. All necessary electric and hydraulic hook-ups are provided, including two auxiliary undercarriage circuits for dumping or tail-gate operation. These trailer functions can be operated from the cab joysticks.

### Automatic digging brake

The optional digging brake automatically activates the service brake and oscillation lock when the machine stops, and it releases them when the machine accelerates again. The operator can fully focus on the job with no need to step on the brake.



## A safe work environment

The SpaceCab™ provides an ergonomic and quiet work environment, with an outstanding view of the jobsite. ROPS certified, it was specifically designed by Komatsu for hydraulic excavators, with a reinforced pipe-structured framework set up on viscous damper mounts for low vibration levels.

## Premium comfort seat (option)

The premium comfort seat comes with suspended joystick consoles, top quality cushioning, auto weight adjustment, pneumatic lumbar support and a climate control system for perfect seat temperature adjustment.

## Low-noise design

Komatsu wheeled excavators have low external noise levels, making them ideal for confined spaces and urban areas. Sound insulation and absorbing materials reduce cabin noise to levels similar to an executive car.

## Increased operator convenience

With a DAB+ radio with Bluetooth®, USB and hands-free kit, 12 V and 24 V power supplies, the cab offers maximum convenience. The automatic air conditioner allows the operator to easily and precisely set the cab's atmosphere.



Ergonomically designed switches that light up for safe and easy night operation



The standard telescopic steering wheel is comfortably adjustable in height and reach

## First-class comfort



### Easy operation

The Komatsu PW168-11 features an operational concept that puts full control of the machine right at the operator's fingertips. Different camera views, undercarriage attachments and the manual axle lock can all be actuated by buttons on top of the operational levers. Without removing the hand from the joystick, the operator can switch from boom operation to undercarriage control for complete and precise control over the parallel dozer blade.

### Widescreen monitor

Installed with a choice of 26 languages, the widescreen monitor with simple switches and multifunction keys gives fingertip access to a large range of functions and operating info.

### Joystick steering

With the optional joystick steering the operator can precisely fingertip control the machine on any jobsite. This allows the easy combined operation of driving and working with the attachment simultaneously.

### Excellent visibility

Perfect visibility from cabin through large windows, mirrors and four standard mounted KomVision cameras with 270° surround view.



## Safety first

### Safe lifting operations

The centrally positioned slewing ring and rear engine provide optimal weight distribution, ensuring equal lifting capacities at both the front and rear while maintaining permissible axle loads across all equipment variants.

### Easy & safe transport to the next job site

With a low construction height of just 3.1 meters, the PW168-11 is easily transportable on standard low loaders with a loading height of up to 4 meters. This design also lowers the machine's center of gravity, enhancing lifting performance and driving stability.

### KomVision

With a series of high definition networked cameras fitted on the machine, KomVision provides a crystal clear, real-time bird's eye view of the immediate surroundings on the widescreen cab monitor. The operator can quickly and easily check the machine's vicinity prior to making any movement, and focus on the work at hand even in low light conditions.

### Optimal jobsite safety

Multiple safety features minimise accident risk in and around the machine. Clearly marked steps and handrails ensure safe access, while a neutral detection system for work equipment levers, a seat belt warning indicator, and an audible travel alarm enhance job site safety. Additionally, durable anti-slip plates with high-friction coverings provide long-term traction performance.

### Safe operation in confined areas

With its short tail, the PW168-11 is ideally suited for operations in the tightest of spaces. Thanks to its minimal tail swing radius, it can work close to obstacles, allowing for minimal barriers around the working area.



Full LED lighting for improved visibility



Handrails and anti-slip plates for convenient and safe maintenance access



## Digital assistance & guidance



### The way to higher productivity

Komtrax turns telematics data into actionable insights for your fleet and equipment, empowering your business to make well-informed, data-driven decisions. By creating a tightly integrated web of support, Komtrax allows for proactive and preventive maintenance to minimise downtime and facilitate peak machine performance.



## Smart Construction 3D Machine Guidance

The optionally available Smart Construction 3D Machine Guidance kit provides customers with a simple and accessible 3D GNSS system, allowing precise digging capabilities. 3D machine guidance uses technology, such as sensors, GPS and computers to improve digging accuracy. It works by comparing where the bucket is in the real world to a 3D digital model, essentially giving operators a virtual guide to assist them in their work. Additionally, it comes with a payload meter option and a customisable safety zone feature.



## Easy maintenance

### Simple and convenient service

Ground level access ensures convenient daily service. Filters are centralised and long service intervals keep machine downtime to a minimum.

### Easy radiator access

Thanks to a side-by-side cooler arrangement, the aftercooler and hydraulic oil radiator can be cleaned easily and repaired individually in case of damage.

### Electric refuelling pump

Standard equipment on all PW168-11 includes an automatic shut-off fuelling pump that allows easy refuelling from a barrel.



### Komatsu Care

Komatsu Care is a maintenance program that comes as standard with your new Komatsu machine. It covers factory-scheduled maintenance, performed with Komatsu Genuine parts by Komatsu-trained technicians. It also offers extended coverage of the Komatsu Diesel Particulate Filter (KDPF) and of the Selective Catalytic Reduction (SCR). Please contact your local Komatsu distributor for terms and conditions.

### Remote greasing bar

The PW168-11 features a centralised system that facilitates the regular greasing of the boom. An optional fully automatic greasing system can handle the regular and proper greasing of the complete machine – prolonging the lifetime and increasing the resale value of the excavator.

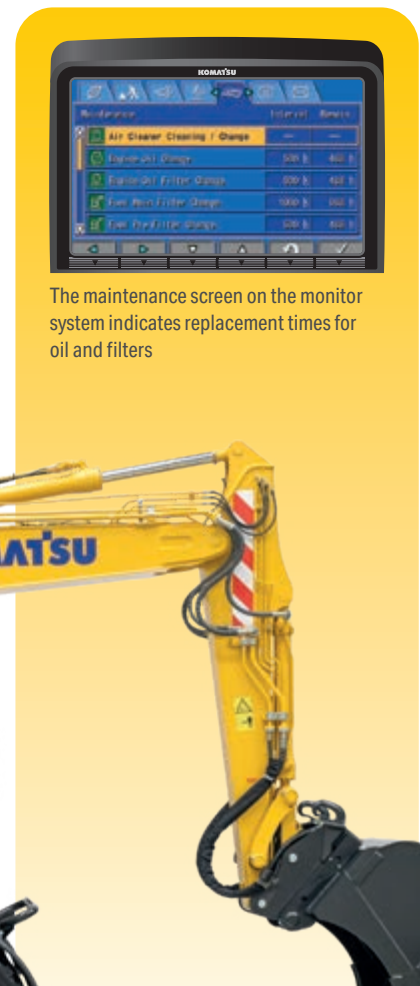

The maintenance screen on the monitor system indicates replacement times for oil and filters



# Specifications

## Engine

Model	Komatsu SAA4D107E-5
Type	Common rail direct injection, water-cooled, emissionised, turbocharged, after-cooled diesel
Engine power	
at rated engine speed	2000 rpm
ISO 14396	110 kW / 148 HP
ISO 9249 (net engine power)	106 kW / 142 HP
No. of cylinders	4
Bore × stroke	107 × 124 mm
Displacement	4.5 l
Air filter type	Double element type with monitor panel dust indicator and auto dust evacuator
Cooling	Suction type cooling fan with radiator fly screen
Fuel	Diesel fuel, conforming to EN590 Class 2/ Grade D. Paraffinic fuel capability (HVO, GTL, BTL), conforming to EN 15940:2016

## Hydraulic system

Type	HydrauMind. Closed-centre load sensing system with pressure compensation valves
Additional circuits	Depending on the specification up to 2 additional proportional control & quick-coupler circuits can be installed
Main pump	Variable displacement piston pump supplying boom, arm, bucket, swing and travel circuits
Maximum pump flow	295 l/min
Relief valve settings	
Implement	380 kg/cm <sup>2</sup>
Travel	420 kg/cm <sup>2</sup>
Swing	290 kg/cm <sup>2</sup>
Pilot circuit	36 kg/cm <sup>2</sup>

## Swing system

Type	Axial piston motor driving through planetary double reduction gearbox
Swing lock	Electrically actuated wet multi-disc brake integrated into swing motor
Swing speed	0 - 11.5 rpm
Swing torque	43 kNm

## Steering system

Steering control	Hydraulic steering system supplied from a separate gear pump and controlled through LS orbitrol & priority valves
Minimum turning radius	6800 mm

# PW168-11E1

## Brake system

Type	Dual circuit hydraulic braking system supplied from a separate gear pump
Service brakes	Pedal actuated wet multi-disc brakes integrated into the axle hubs
Parking brake	Electrically actuated wet multi-disc "spring actuation hydraulic release" brake integrated into the transmission

## Transmission

Type	Fully automatic power shift transmission with permanent 4 wheel drive
Travel motors	One variable displacement axial piston motor
Maximum pressure	380 bar
Travel modes	Automatic + 3 travel modes
Max. travel speeds	
Hi / Lo / Creep	35.0 / 10.0 / 2.5 km/h
	A max. speed restriction of 20 km/h is available as an option
Maximum drawbar pull	10900 kg
Axle oscillation	8° Lockable in any position from the operator cab

## Service refill capacities

Fuel tank	267 l
Radiator	22 l
Engine oil	18 l
Swing drive	5.5 l
Hydraulic tank	90 l
Transmission	3.0 l
Front differential	9.5 l
Rear differential	12.4 l
Front axle hub	2.5 l
Rear axle hub	2.5 l
Swing pinion grease bath amount	9.0 l
AdBlue® tank	57.7 l

## Environment

Engine emissions	Fully complies with EU Stage V exhaust emission regulations
Noise levels	
LwA external	99 dB(A) (2000/14/EC Stage II)
LpA operator ear	69 dB(A) (ISO 6396 dynamic test)
Vibration levels (EN 12096:1997)	
Hand/arm	≤ 2.5 m/s <sup>2</sup> (uncertainty K = 0.34 m/s <sup>2</sup> )
Body	≤ 0.5 m/s <sup>2</sup> (uncertainty K = 0.16 m/s <sup>2</sup> )
Contains fluorinated greenhouse gas HFC-134a (GWP 1430). Quantity of gas 0.9 kg; CO <sub>2</sub> equivalent 1.29 t	



### Operating weight (appr.)

Undercarriage attachment type	Mono boom	Two-piece boom
Without	15775 kg	16030 kg
Rear blade	16520 kg	16780 kg
Rear outrigger	16815 kg	17075 kg
2 outriggers + blade	17560 kg	17820 kg
4 outriggers	17855 kg	18115 kg

Operating weight, including specified work equipment, 2500 mm arm, operator, lubricant, coolant, full fuel tank, bucket (475 kg) and the standard equipment.

### Max. bucket capacity and weight

Arm length	Mono boom		
	2100 mm	2500 mm	3000 mm
Material weight up to 1.2 t/m <sup>3</sup>	1.13 m <sup>3</sup> 770 kg	1.04 m <sup>3</sup> 743 kg	0.75 m <sup>3</sup> 600 kg
Material weight up to 1.5 t/m <sup>3</sup>	1.04 m <sup>3</sup> 743 kg	0.85 m <sup>3</sup> 640 kg	0.66 m <sup>3</sup> 535 kg
Material weight up to 1.8 t/m <sup>3</sup>	0.85 m <sup>3</sup> 640 kg	0.75 m <sup>3</sup> 600 kg	0.56 m <sup>3</sup> 520 kg

Arm length	Two-piece boom		
	2100 mm	2500 mm	3000 mm
Material weight up to 1.2 t/m <sup>3</sup>	1.13 m <sup>3</sup> 770 kg	1.04 m <sup>3</sup> 743 kg	0.85 m <sup>3</sup> 640 kg
Material weight up to 1.5 t/m <sup>3</sup>	1.13 m <sup>3</sup> 770 kg	0.94 m <sup>3</sup> 680 kg	0.75 m <sup>3</sup> 600 kg
Material weight up to 1.8 t/m <sup>3</sup>	0.94 m <sup>3</sup> 680 kg	0.75 m <sup>3</sup> 600 kg	0.66 m <sup>3</sup> 535 kg

Max. capacity and weight have been calculated according to ISO 10567:2007.

Please consult with your distributor for the correct selection of buckets and attachments to suit the application.

### Bucket and arm force

Arm length	2100 mm	2500 mm	3000 mm
Bucket digging force	94 kN	94 kN	94 kN
Bucket digging force at PowerMax	102 kN	102 kN	102 kN
Arm crowd force	71 kN	63 kN	56 kN
Arm crowd force at PowerMax	77 kN	68 kN	61 kN

# Dimensions and performance figures

## Mono boom

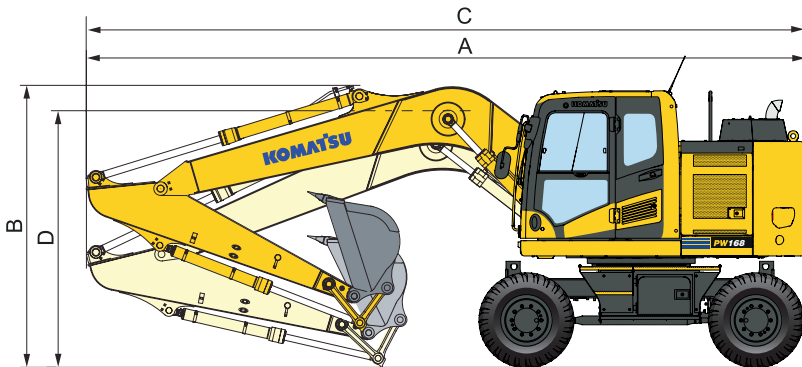

### Driving position

Arm length	A	B
2100 mm	7675 mm	3905 mm
2500 mm	7675 mm	3905 mm
3000 mm *	7780 mm	3850 mm

### Transport position

Arm length	C	D
2100 mm	8035 mm	3080 mm
2500 mm	8035 mm	3080 mm
3000 mm	8035 mm	3080 mm

\* Driving position without bucket

## Two-piece boom

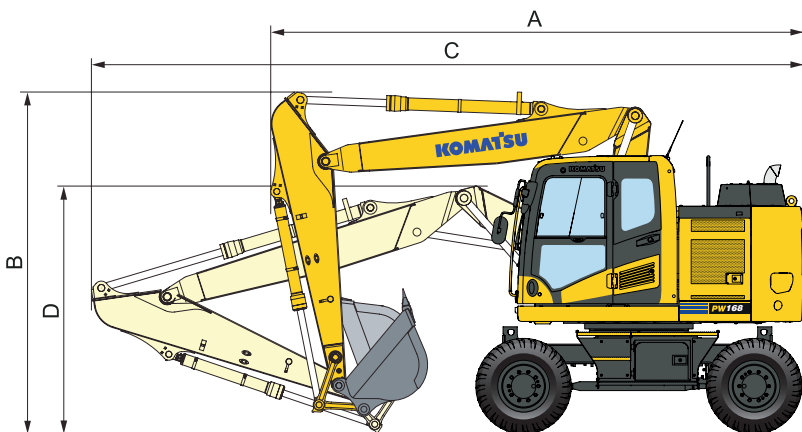

### Driving position

Arm length	A	B
2100 mm	5890 mm	3950 mm
2500 mm	6030 mm	4000 mm
3000 mm *	6115 mm	3950 mm

### Transport position

Arm length	C	D
2100 mm	7880 mm	2710 mm
2500 mm	7900 mm	2790 mm
3000 mm	7890 mm	3005 mm

\* Driving position without bucket

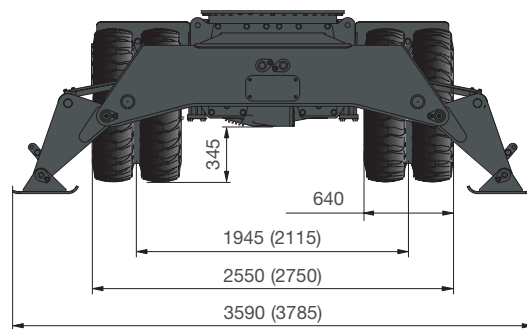
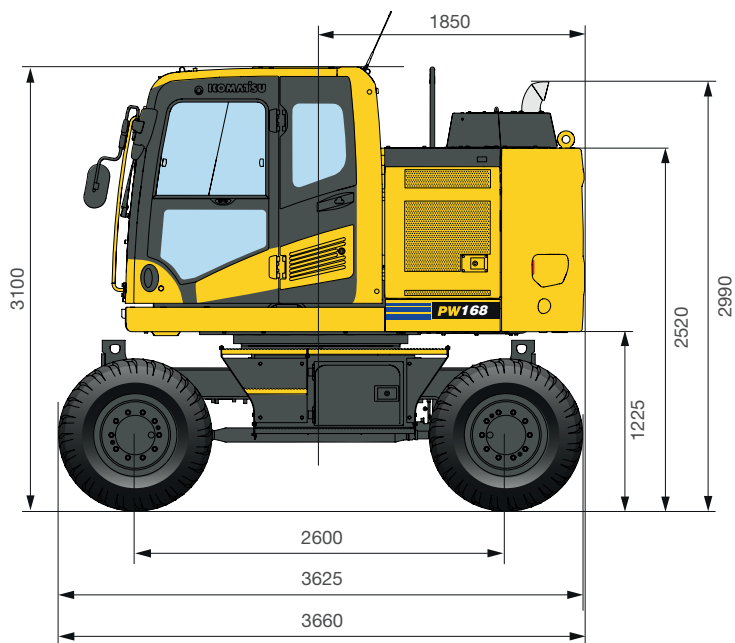

All dimensions with tyres Bandenmarkt Excavator 315/70 R22.5

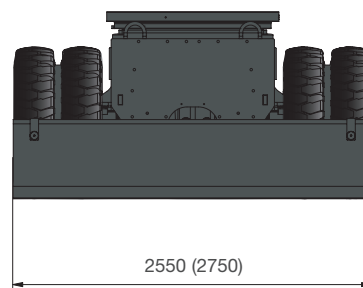

( ): Figures for 2.75 m undercarriage

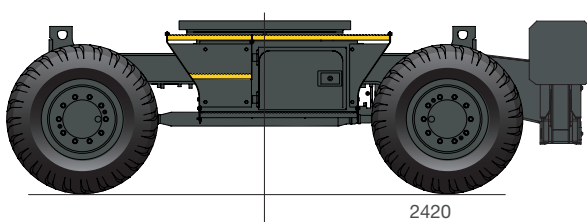
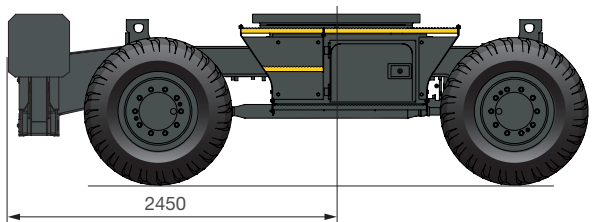
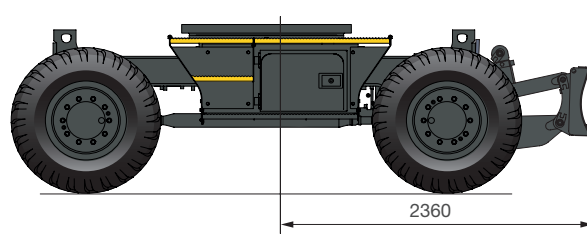
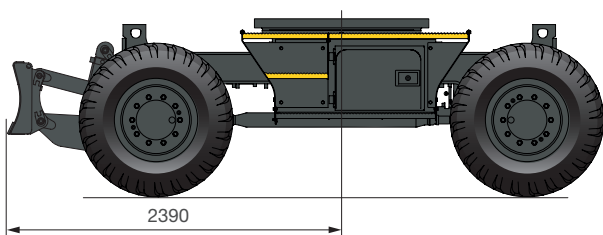

# Working range

## Mono boom

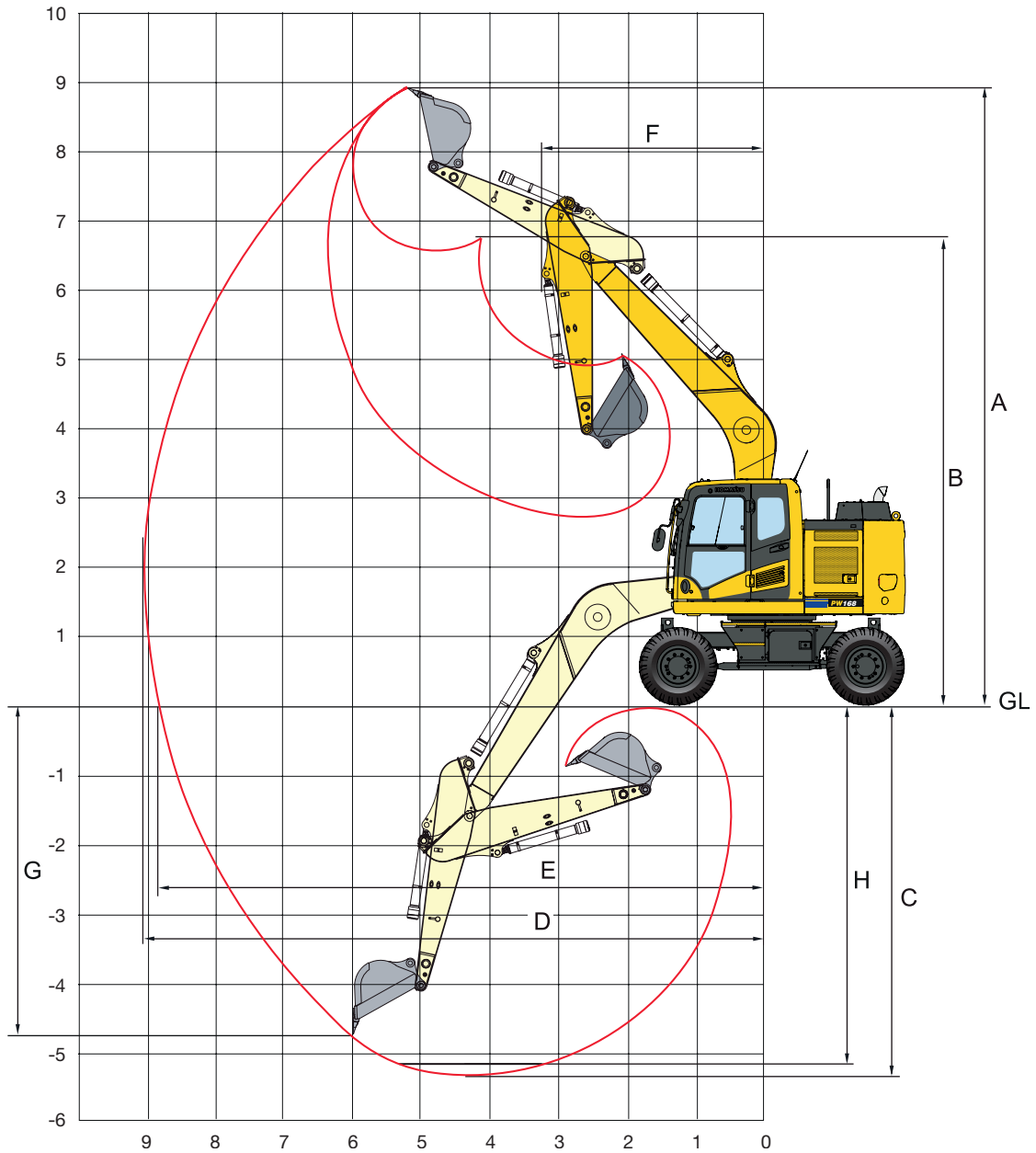

Arm length	2100 mm	2500 mm	3000 mm
A Max. digging height	8765 mm	8970 mm	9320 mm
B Max. dumping height	6440 mm	6655 mm	6970 mm
C Max. digging depth	4885 mm	5270 mm	5720 mm
D Max. digging reach	8700 mm	9065 mm	9555 mm
E Max. digging reach at ground level	8515 mm	8895 mm	9385 mm
F Min. swing radius	3095 mm	3060 mm	3110 mm
G Max. vertical wall digging depth	3560 mm	3930 mm	4490 mm
H Max. digging depth of cut for 2440 mm level	4715 mm	5155 mm	5690 mm

Two-piece boom

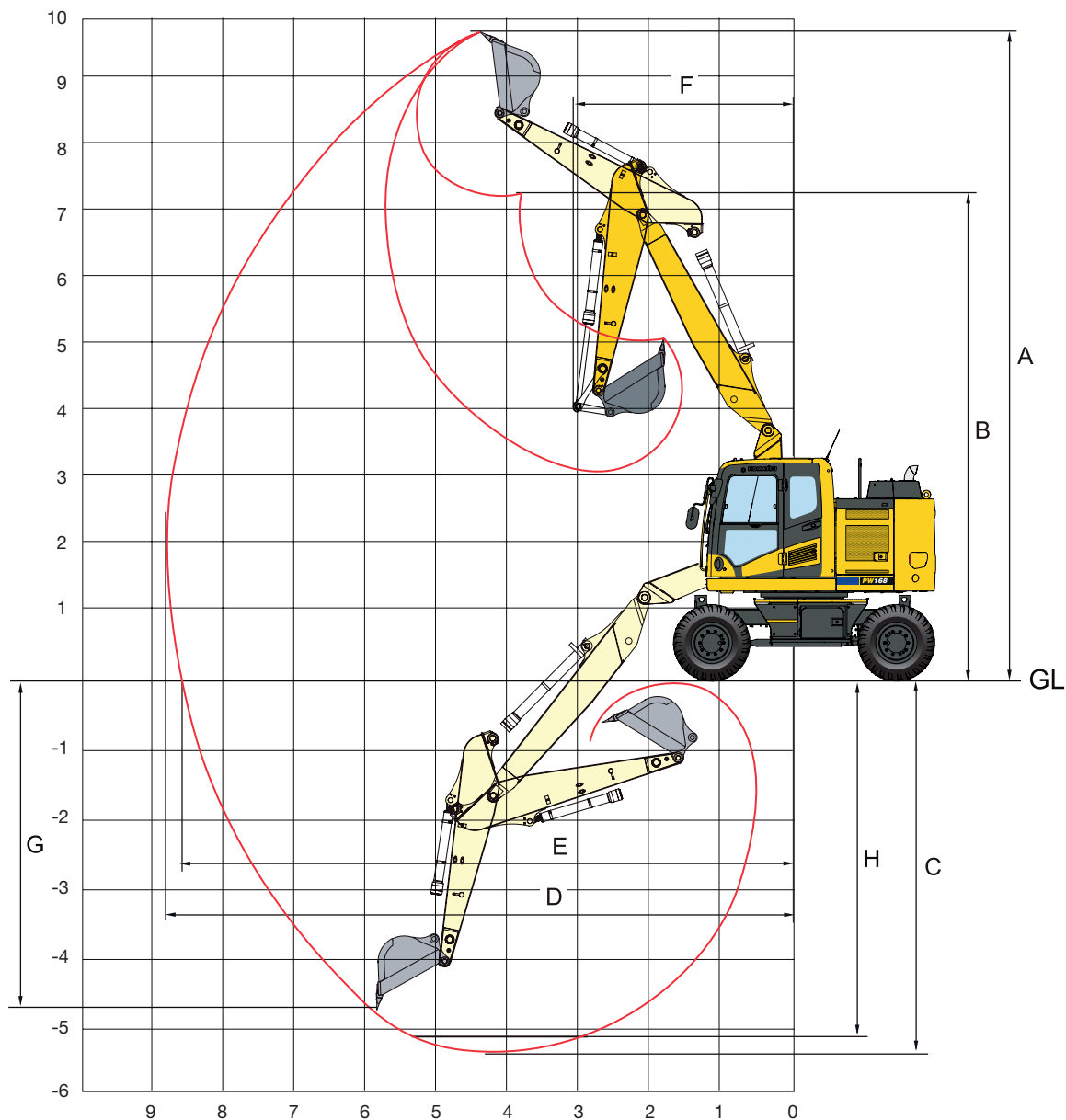





Arm length

	2100 mm	2500 mm	3000 mm
A Max. digging height	9615	9910	10360
B Max. dumping height	7035	7335	7765
C Max. digging depth	5060	5455	5965
D Max. digging reach	8595	8970	9475
E Max. digging reach at ground level	8325	8775	9260
F Min. swing radius	2330	2425	2700
G Max. vertical wall digging depth	3545	3910	4395
H Max. digging depth of cut for 2440 mm level	4935	5345	5860

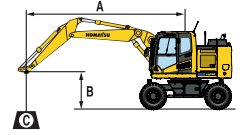
Lifting capacity / mono boom / undercarriage width 2.55 m

Arm length	A B	7.5 m		6.0 m		4.5 m		3.0 m		1.5 m					
		Rating over front	Rating over side	Rating over front	Rating over side	Rating over front	Rating over side	Rating over front	Rating over side	Rating over front	Rating over side				
 Without stabiliser	2100 mm	7.5 m	kg	*2850	*2850										
		6.0 m	kg	*2450	2250		3550	2550							
		4.5 m	kg	*2350	1800		3450	2450	5450	3800					
		3.0 m	kg	2350	1650	2400	1650	3350	2350	5100	3550				
		1.5 m	kg	2250	1550	2350	1650	3200	2250	4800	3250				
		0.0 m	kg	2300	1600		3100	2100	4650	3100					
		-1.5 m	kg	2550	1750		3100	2100	4600	3050	*8250	5500			
		-3.0 m	kg	3200	2200				4650	3100	*6800	5600			
		-4.5 m	kg												
	2500 mm	7.5 m	kg	*2300	*2300										
		6.0 m	kg	*2050	2050		3600	2550							
		4.5 m	kg	*2000	1650	*2250	1700	3500	2500						
		3.0 m	kg	*2000	1500	2400	1650	3350	2350	5200	3600				
		1.5 m	kg	2100	1450	2350	1600	3200	2250	4850	3300				
		0.0 m	kg	2150	1450	2250	1550	3100	2100	4650	3100	*4700	*4700		
		-1.5 m	kg	2350	1600		3050	2050	4550	3000	*7700	5400	*4600	*4600	
		-3.0 m	kg	2850	1950		3050	2100	4600	3050	*7800	5500			
		-4.5 m	kg												
	3000 mm	7.5 m	kg	*1900	*1900		*2400	*2400							
		6.0 m	kg	*1700	*1700		*3300	2550							
		4.5 m	kg	*1650	1500	2400	1700	3500	2500						
		3.0 m	kg	*1650	1350	2400	1650	3350	2350	5250	3600	*9450	6650		
		1.5 m	kg	*1700	1250	2300	1550	3150	2200	4850	3300				
		0.0 m	kg	1900	1300	2250	1500	3050	2050	4600	3000	*5000	*5000		
		-1.5 m	kg	2050	1350	2200	1500	2950	1950	4450	2900	*7000	5250	*4000	*4000
		-3.0 m	kg	2400	1650		2950	1950	4450	2900	8700	5300	*6600	*6600	
		-4.5 m	kg	*2600	2250					*4000	3000	*5450	*5450		





- A – Reach from swing center
  - B – Bucket hook height
  - C – Lifting capacities, including bucket linkage (136 kg) and bucket cylinder (96 kg)
-  – Rating over front
  -  – Rating over side
  -  – Rating at maximum reach

 Front or rear blade	2100 mm	7.5 m	kg	*2850	*2850										
		6.0 m	kg	*2450	*2450		*3750	2950							
		4.5 m	kg	*2350	2150		*5150	2850	*6150	4450					
		3.0 m	kg	*2350	1950	*2950	1950	*5550	2750	*7250	4150				
		1.5 m	kg	*2500	1850	*3800	1950	*5850	2600	*8000	3850				
		0.0 m	kg	*2800	1900		*5800	2550	*8000	3700					
		-1.5 m	kg	*3350	2100		*5200	2500	*7050	3650	*8250	6700			
		-3.0 m	kg	*3450	2600				*5350	3750	*6800	*6800			
		-4.5 m	kg												
	2500 mm	7.5 m	kg	*2300	*2300										
		6.0 m	kg	*2050	*2050		*3650	3000							
		4.5 m	kg	*2000	1950	*2250	2000	*4600	2900						
		3.0 m	kg	*2000	1800	*3650	1950	*5350	2750	*6900	4200				
		1.5 m	kg	*2100	1700	*4450	1900	*5750	2600	*7800	3900				
		0.0 m	kg	*2300	1750	*4350	1850	*5850	2550	*8000	3700	*4700	*4700		
		-1.5 m	kg	*2750	1900		*5400	2450	*7350	3600	*7700	6600	*4600	*4600	
		-3.0 m	kg	*3500	2300		*4100	2500	*5850	3650	*7800	6750			
		-4.5 m	kg												
	3000 mm	7.5 m	kg	*1900	*1900		*2400	*2400							
		6.0 m	kg	*1700	*1700		*3300	3000							
		4.5 m	kg	*1650	*1650	*2950	2000	*3800	2900						
		3.0 m	kg	*1650	1600	*3700	1950	*5000	2750	*6350	4250	*9450	7950		
		1.5 m	kg	*1700	1500	*4450	1850	*5550	2600	*7450	3900				
		0.0 m	kg	*1900	1550	*4450	1800	*5750	2450	*7900	3600	*5000	*5000		
		-1.5 m	kg	*2200	1650	*4050	1800	*5500	2400	*7550	3500	*7000	6450	*4000	*4000
		-3.0 m	kg	*2800	1950		*4600	2400	*6350	3500	*8850	6500	*6600	*6600	
		-4.5 m	kg	*2600	*2600					*4000	3650	*5450	*5450		

When removing linkage or cylinder, lifting capacities can be increased by their respective weights.

\* Load is limited by hydraulic capacity rather than tipping. Ratings are based on ISO standard 10567. Rated loads do not exceed 87% of hydraulic lift capacity or 75% of tipping load.

 Rear outrigger	2100 mm	7.5 m	kg	*2850	*2850										
		6.0 m	kg	*2450	*2450		*3750	3650							
		4.5 m	kg	*2350	*2350		*5150	3600	*6150	5650					
		3.0 m	kg	*2350	*2350	*2950	2500	*5550	3450	*7250	5300				
		1.5 m	kg	*2500	2350	*3800	2450	*5850	3350	*8000	5000				
		0.0 m	kg	*2800	2400		*5800	3250	*8000	4800					
		-1.5 m	kg	*3350	2700		*5200	3200	*7050	4800	*8250	*8250			
		-3.0 m	kg	*3450	3300				*5350	4850	*6800	*6800			
		-4.5 m	kg												
	2500 mm	7.5 m	kg	*2300	*2300										
		6.0 m	kg	*2050	*2050		*3650	*3650							
		4.5 m	kg	*2000	*2000	*2250	*4600	3600							
		3.0 m	kg	*2000	*2000	*3650	2500	*5350	3500	*6900	5400				
		1.5 m	kg	*2100	*2100	*4450	2400	*5750	3350	*7800	5050				
		0.0 m	kg	*2300	2250	*4350	2400	*5850	3250	*8000	4800	*4700	*4700		
		-1.5 m	kg	*2750	2450		*5400	3150	*7350	4750	*7700	*7700	*4600	*4600	
		-3.0 m	kg	*3500	2950		*4100	3200	*5850	4800	*7800	*7800			
		-4.5 m	kg												
	3000 mm	7.5 m	kg	*1900	*1900		*2400	*2400							
		6.0 m	kg	*1700	*1700		*3300	*3300							
		4.5 m	kg	*1650	*1650	*2950	2550	*3800	3650						
		3.0 m	kg	*1650	*1650	*3700	2500	*5000	3500	*6350	5400	*9450	*9450		
		1.5 m	kg	*1700	*1700	*4450	2400	*5550	3300	*7450	5050				
		0.0 m	kg	*1900	*1900	4450	2300	*5750	3150	*7900	4800	*5000	*5000		
		-1.5 m	kg	*2200	2150	*4050	2250	*5500	3100	*7550	4650	*7000	*7000	*4000	*4000
		-3.0 m	kg	*2800	2550		*4600	3100	*6350	4650	*8850	*8850	*6600	*6600	
		-4.5 m	kg	*2600	*2600					*4000	*4000	*5450	*5450		

Arm length	A	B	7.5 m		6.0 m		4.5 m		3.0 m		1.5 m		
			Rating at maximum reach	Rating over side	Rating at maximum reach	Rating over side	Rating at maximum reach	Rating over side	Rating at maximum reach	Rating over side	Rating at maximum reach	Rating over side	
 Outrigger + blade	2100 mm	7.5 m	kg	*2850	*2850								
		6.0 m	kg	*2450	*2450		*3750	*3750					
		4.5 m	kg	*2350	*2350		*5150	4500	*6150	*6150			
		3.0 m	kg	*2350	*2350	*2950	*2950	*5550	4350	*7250	6750		
		1.5 m	kg	*2500	*2500	*3800	3050	*5850	4200	*8000	6400		
		0.0 m	kg	*2800	*2800			*5800	4100	*8000	6200		
	2500 mm	-1.5 m	kg	*3350	3350			*5200	4050	*7050	6150	*8250	*8250
		-3.0 m	kg	*3450	*3450					*5350	*5350	*6800	*6800
		-4.5 m	kg										
		7.5 m	kg	*2300	*2300								
		6.0 m	kg	*2050	*2050			*3650	*3650				
		4.5 m	kg	*2000	*2000	*2250	*2250	*4600	4500				
3000 mm	3.0 m	kg	*2000	*2000	*3650	3150	*5350	4350	*6900	6800			
	1.5 m	kg	*2100	*2100	*4450	3050	*5750	4200	*7800	6450			
	0.0 m	kg	*2300	*2300	*4350	3000	*5850	4050	*8000	6200	*4700	*4700	
	-1.5 m	kg	*2750	*2750			*5400	4050	*7350	6150	*7700	*7700	
	-3.0 m	kg	*3500	*3500			*4100	4050	*5850	*5850	*7800	*7800	
	-4.5 m	kg											

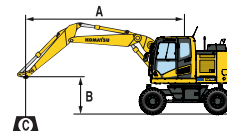

A - Reach from swing center

B - Bucket hook height

C - Lifting capacities, including bucket linkage (136 kg) and bucket cylinder (96 kg)

 - Rating over front

 - Rating over side



 - Rating at maximum reach

When removing linkage or cylinder, lifting capacities can be increased by their respective weights.

\* Load is limited by hydraulic capacity rather than tipping. Ratings are based on ISO standard 10567. Rated loads do not exceed 87% of hydraulic lift capacity or 75% of tipping load.

 Outrigger front + rear	2100 mm	7.5 m	kg	*2850	*2850								
		6.0 m	kg	*2450	*2450		*3750	*3750					
		4.5 m	kg	*2350	*2350		*5150	*5150	*6150	*6150			
		3.0 m	kg	*2350	*2350	*2950	*2950	*5550	5350	*7250	7250		
		1.5 m	kg	*2500	*2500	*3800	3750	*5850	5200	*8000	8000		
		0.0 m	kg	*2800	*2800			*5800	5100	*8000	7950		
	2500 mm	-1.5 m	kg	*3350	*3350			*5200	5050	*7050	7050	*8250	*8250
		-3.0 m	kg	*3450	*3450					*5350	*5350	*6800	*6800
		-4.5 m	kg										
		7.5 m	kg	*2300	*2300								
		6.0 m	kg	*2050	*2050			*3650	*3650				
		4.5 m	kg	*2000	*2000	*2250	*2250	*4600	*4600				
3000 mm	3.0 m	kg	*2000	*2000	*3650	*3650	*5350	5350	*6900	*6900			
	1.5 m	kg	*2100	*2100	*4450	3750	*5750	5200	*7800	*7800			
	0.0 m	kg	*2300	*2300	*4350	3700	*5850	5100	*8000	7950	*4700	*4700	
	-1.5 m	kg	*2750	*2750			*5400	5000	*7350	*7350	*7700	*7700	
	-3.0 m	kg	*3500	*3500			*4100	*4100	*5850	*5850	*7800	*7800	
	-4.5 m	kg											

Lifting capacity / two-piece boom / undercarriage width 2.55 m

Arm length	A	⊗		7.5 m		6.0 m		4.5 m		3.0 m		1.5 m		
		B		B		B		B		B		B		
		⊗	⊗	⊗	⊗	⊗	⊗	⊗	⊗	⊗	⊗	⊗	⊗	
 Without stabiliser	2100 mm	7.5 m kg	*3150	*3150					*4150	3950				
		6.0 m kg	*2650	2300			3550	2500	*4850	4050				
		4.5 m kg	*2550	1850			3500	2450	5500	3850	*5700	*5700		
		3.0 m kg	2400	1650			3350	2350	5200	3550				
		1.5 m kg	2300	1600	2350	1650	3250	2250	4850	3300				
		0.0 m kg	2400	1650			3150	2100	4650	3100	*4150	*4150		
		-1.5 m kg	2650	1800			3100	2100	4650	3050	*8350	5500		
		-3.0 m kg	3700	2500					4700	3150				
		-4.5 m kg												
	2500 mm	7.5 m kg	*2550	*2550					*3950	*3950				
		6.0 m kg	*2250	2100			3600	2550	*4050	4050				
		4.5 m kg	*2100	1700			3550	2500	*4650	3900				
		3.0 m kg	*2150	1500	2400	1650	3400	2400	5250	3600	10200	6500		
		1.5 m kg	2100	1500	2350	1600	3250	2250	4900	3300				
		0.0 m kg	2200	1500	2300	1550	3150	2100	4650	3100	*4700	*4700		
		-1.5 m kg	2400	1650			3050	2100	4600	3000	*7800	5400		
		-3.0 m kg	2950	2000			3100	2100	4650	3050				
		-4.5 m kg												
	3000 mm	7.5 m kg	*2100	*2100			*2400	*2400						
		6.0 m kg	*1850	1800			*3300	2550						
		4.5 m kg	*1750	1500	2450	1700	3550	2500	*3550	*3550				
		3.0 m kg	*1750	1350	2400	1650	3400	2400	5300	3650	*9100	6750		
		1.5 m kg	*1850	1300	2300	1550	3200	2200	4900	3300				
		0.0 m kg	1950	1300	2250	1500	3050	2100	4650	3050	*4950	*4950		
		-1.5 m kg	2100	1400	2200	1500	3000	2000	4500	2950	*7050	5250	*3800	*3800
		-3.0 m kg	2500	1650			3000	2000	4500	2950	8750	5300		
		-4.5 m kg												
 Front or rear blade	2100 mm	7.5 m kg	*3150	*3150					*4150	*4150				
		6.0 m kg	*2650	*2650			*3700	2900	*4850	4650				
		4.5 m kg	*2550	2200			*5150	2900	*5750	4500	*5700	*5700		
		3.0 m kg	*2550	1950			*5800	2750	*7400	4200				
		1.5 m kg	*2650	1900	*3400	1950	*6300	2650	*8600	3900				
		0.0 m kg	*2950	1950			*6450	2550	*8850	3750	*4150	*4150		
		-1.5 m kg	*3500	2150			*6050	2500	*8350	3700	*8350	6750		
		-3.0 m kg	*5400	3000					*6700	3750				
		-4.5 m kg												
	2500 mm	7.5 m kg	*2550	*2550					*3950	*3950				
		6.0 m kg	*2250	*2250			*3700	3000	*4050	*4050				
		4.5 m kg	*2100	2000			*4450	2900	*4650	4550				
		3.0 m kg	*2150	1800	*3600	1950	*5600	2800	*7000	4250	*10700	7800		
		1.5 m kg	*2250	1750	*4350	1900	*6100	2650	*8250	3900				
		0.0 m kg	*2450	1800	*4100	1850	*6400	2550	*8850	3750	*4700	*4700		
		-1.5 m kg	*2900	1950			*6200	2450	*8500	3650	*7800	6650		
		-3.0 m kg	*4050	2400			*5000	2500	*7250	3650				
		-4.5 m kg												
	3000 mm	7.5 m kg	*2100	*2100			*2400	*2400						
		6.0 m kg	*1850	*1850			*3300	3000						
		4.5 m kg	*1750	*1750	*2950	2000	*3700	2950	*3550	*3550				
		3.0 m kg	*1750	1600	*3650	1950	*4700	2800	*5700	4300	*9100	8100		
		1.5 m kg	*1850	1550	*4350	1900	*5850	2600	*7800	3900				
		0.0 m kg	*2000	1550	4700	1800	*6300	2450	*8600	3650	*4950	*4950		
		-1.5 m kg	*2300	1700	*3900	1800	*6250	2400	*8600	3550	*7050	6450	*3800	*3800
		-3.0 m kg	*2900	2000			*5500	2400	*7700	3550	*10950	6550		
		-4.5 m kg												
 Rear outrigger	2100 mm	7.5 m kg	*3150	*3150					*4150	*4150				
		6.0 m kg	*2650	*2650			*3700	3650	*4850	*4850				
		4.5 m kg	*2550	*2550			*5150	3600	*5750	5650	*5700	*5700		
		3.0 m kg	*2550	2500			*5800	3450	*7400	5350				
		1.5 m kg	*2650	2400	*3400	2400	*6300	3350	*8600	5000				
		0.0 m kg	*2950	2450			*6450	3250	*8850	4800	*4150	*4150		
		-1.5 m kg	*3500	2700			*6050	3200	*8350	4800	*8350	*8350		
		-3.0 m kg	*5400	3800					*6700	4850				
		-4.5 m kg												
	2500 mm	7.5 m kg	*2550	*2550					*3950	*3950				
		6.0 m kg	*2250	*2250			*3700	3700	*4050	*4050				
		4.5 m kg	*2100	*2100			*4450	3600	*4650	*4650				
		3.0 m kg	*2150	*2150	*3600	2500	*5600	3500	*7000	5400	*10700	10400		
		1.5 m kg	*2250	2250	*4350	2400	*6100	3350	*8250	5050				
		0.0 m kg	*2450	2250	*4100	2400	*6400	3250	*8850	4800	*4700	*4700		
		-1.5 m kg	*2900	2500			*6200	3150	*8500	4750	*7800	*7800		
		-3.0 m kg	*4050	3050			*5000	3200	*7250	4800				
		-4.5 m kg												
	3000 mm	7.5 m kg	*2100	*2100			*2400	*2400						
		6.0 m kg	*1850	*1850			*3300	*3300						
		4.5 m kg	*1750	*1750	*2950	2550	*3700	3650	*3550	*3550				
		3.0 m kg	*1750	*1750	*3650	2450	*4700	3500	*5700	5450	*9100	*9100		
		1.5 m kg	*1850	*1850	*4350	2400	*5850	3300	*7800	5050				
		0.0 m kg	*2000	*2000	4500	2300	*6300	3150	*8600	4800	*4950	*4950		
		-1.5 m kg	*2300	2200	*3900	2300	*6250	3100	*8600	4650	*7050	*7050	*3800	*3800
		-3.0 m kg	*2900	2550			*5500	3100	*7700	4650	*10950	9000		
		-4.5 m kg												

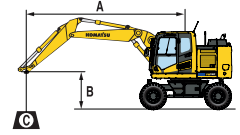

- A – Reach from swing center
- B – Bucket hook height
- C – Lifting capacities, including bucket linkage (136 kg) and bucket cylinder (96 kg)

- ⊗ – Rating over front
- ⊗ – Rating over side
- ⊗ – Rating at maximum reach

When removing linkage or cylinder, lifting capacities can be increased by their respective weights.

\* Load is limited by hydraulic capacity rather than tipping. Ratings are based on ISO standard 10567. Rated loads do not exceed 87% of hydraulic lift capacity or 75% of tipping load.



Arm length	A	⊗		7.5 m		6.0 m		4.5 m		3.0 m		1.5 m	
		B	⊗	⊗	⊗	⊗	⊗	⊗	⊗	⊗	⊗	⊗	⊗

 <p>Outrigger + blade</p>	2100 mm	7.5 m	kg	*3150	*3150			*4150	*4150					
		6.0 m	kg	*2650	*2650			*3700	*3700	*4850	*4850			
		4.5 m	kg	*2550	*2550			*5150	4500	*5750	*5750	*5700	*5700	
		3.0 m	kg	*2550	*2550			*5800	4350	*7400	6750			
		1.5 m	kg	*2650	*2650	*3400	3050	*6300	4200	*8600	6450			
		0.0 m	kg	*2950	*2950			*6450	4100	*8850	6250	*4150	*4150	
		- 1.5 m	kg	*3500	3450			*6050	4050	*8350	6150	*8350	*8350	
		- 3.0 m	kg	*5400	4850					*6700	6250			
	- 4.5 m	kg												
	2500 mm	7.5 m	kg	*2550	*2550				*3950	*3950				
		6.0 m	kg	*2250	*2250			*3700	*3700	*4050	*4050			
		4.5 m	kg	*2100	*2100			*4450	*4450	*4650	*4650			
		3.0 m	kg	*2150	*2150	*3600	3150	*5600	4350	*7000	6850	*10700	*10700	
		1.5 m	kg	*2250	*2250	*4350	3050	*6100	4200	*8250	6450			
		0.0 m	kg	*2450	*2450	*4100	3000	*6400	4100	*8850	6200	*4700	*4700	
		- 1.5 m	kg	*2900	*2900			*6200	4050	*8500	6050	*7800	*7800	
		- 3.0 m	kg	*4050	3850			*5000	4050	*7250	6150			
	- 4.5 m	kg												
	3000 mm	7.5 m	kg	*2100	*2100			*2400	*2400					
		6.0 m	kg	*1850	*1850			*3300	*3300					
		4.5 m	kg	*1750	*1750	*2950	*2950	*3700	*3700	*3550	*3550			
		3.0 m	kg	*1750	*1750	*3650	3100	*4700	4350	*5700	*5700	*9100	*9100	
		1.5 m	kg	*1850	*1850	*4350	3000	*5850	4200	*7800	6450			
		0.0 m	kg	*2000	*2000	*4900	2950	*6300	4050	*8600	6150	*4950	*4950	
- 1.5 m		kg	*2300	*2300	*3900	2900	*6250	3950	*8600	6050	*7050	*7050	*3800	
- 3.0 m		kg	*2900	*2900			*5500	3950	*7700	6050	*10950	*10950		
- 4.5 m	kg													

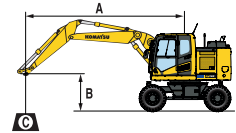

A - Reach from swing center

B - Bucket hook height

C - Lifting capacities, including bucket linkage (136 kg) and bucket cylinder (96 kg)

⊗ - Rating over front

⊗ - Rating over side



⊗ - Rating at maximum reach

When removing linkage or cylinder, lifting capacities can be increased by their respective weights.

\* Load is limited by hydraulic capacity rather than tipping. Ratings are based on ISO standard 10567. Rated loads do not exceed 87% of hydraulic lift capacity or 75% of tipping load.

 <p>Outrigger front + rear</p>	2100 mm	7.5 m	kg	*3150	*3150			*4150	*4150					
		6.0 m	kg	*2650	*2650			*3700	*3700	*4850	*4850			
		4.5 m	kg	*2550	*2550			*5150	4500	*5750	*5750	*5700	*5700	
		3.0 m	kg	*2550	*2550			*5800	4350	*7400	6750			
		1.5 m	kg	*2650	*2650	*3400	3050	*6300	4200	*8600	6450			
		0.0 m	kg	*2950	*2950			*6450	4100	*8850	6250	*4150	*4150	
		- 1.5 m	kg	*3500	3450			*6050	4050	*8350	6150	*8350	*8350	
		- 3.0 m	kg	*5400	4850					*6700	6250			
	- 4.5 m	kg												
	2500 mm	7.5 m	kg	*2550	*2550				*3950	*3950				
		6.0 m	kg	*2250	*2250			*3700	*3700	*4050	*4050			
		4.5 m	kg	*2100	*2100			*4450	*4450	*4650	*4650			
		3.0 m	kg	*2150	*2150	*3600	3150	*5600	4350	*7000	6850	*10700	*10700	
		1.5 m	kg	*2250	*2250	*4350	3050	*6100	4200	*8250	6450			
		0.0 m	kg	*2450	*2450	*4100	3000	*6400	4100	*8850	6200	*4700	*4700	
		- 1.5 m	kg	*2900	*2900			*6200	4050	*8500	6050	*7800	*7800	
		- 3.0 m	kg	*4050	3850			*5000	4050	*7250	6150			
	- 4.5 m	kg												
	3000 mm	7.5 m	kg	*2100	*2100			*2400	*2400					
		6.0 m	kg	*1850	*1850			*3300	*3300					
		4.5 m	kg	*1750	*1750	*2950	*2950	*3700	*3700	*3550	*3550			
		3.0 m	kg	*1750	*1750	*3650	3100	*4700	4350	*5700	*5700	*9100	*9100	
		1.5 m	kg	*1850	*1850	*4350	3000	*5850	4200	*7800	6450			
		0.0 m	kg	*2000	*2000	*4900	2950	*6300	4050	*8600	6150	*4950	*4950	
- 1.5 m		kg	*2300	*2300	*3900	2900	*6250	3950	*8600	6050	*7050	*7050	*3800	
- 3.0 m		kg	*2900	*2900			*5500	3950	*7700	6050	*10950	*10950		
- 4.5 m	kg													

Lifting capacity / mono boom / undercarriage width 2.75 m

Arm length	A B	⊗		7.5 m		6.0 m		4.5 m		3.0 m		1.5 m		
		⊗	⊗	⊗	⊗	⊗	⊗	⊗	⊗	⊗	⊗	⊗	⊗	
		⊗	⊗	⊗	⊗	⊗	⊗	⊗	⊗	⊗	⊗	⊗	⊗	⊗
 <p>Without stabiliser</p>	2100 mm	7.5 m	kg	*2850	*2850									
		6.0 m	kg	*2450	*2450		3550	2750						
		4.5 m	kg	*2350	2050		3500	2700	5450	4200				
		3.0 m	kg	2350	1800	2400	1850	3350	2600	5150	3900			
		1.5 m	kg	2250	1750	2350	1800	3250	2450	4800	3600			
		0.0 m	kg	2350	1800			3150	2400	4650	3450			
	2500 mm	-1.5 m	kg	2550	1950			3100	2350	4650	3450	*8250	6250	
		-3.0 m	kg	3200	2400					4650	3450	*6800	6350	
		-4.5 m	kg											
		7.5 m	kg	*2300	*2300									
		6.0 m	kg	*2050	*2050		3600	2800						
		4.5 m	kg	*2000	1850	*2250	1900	3500	2700					
3000 mm	3.0 m	kg	*2000	1650	2400	1850	3400	2600	5200	3950				
	1.5 m	kg	*2100	1600	2350	1800	3250	2450	4850	3650				
	0.0 m	kg	2150	1650	2250	1750	3100	2350	4650	3450	*4700	*4700		
	-1.5 m	kg	2350	1800			3050	2300	4600	3400	*7700	6150	*4600	*4600
	-3.0 m	kg	2850	2150			3100	2350	4650	3400	*7800	6300		
	-4.5 m	kg												
 <p>Front or rear blade</p>	2100 mm	7.5 m	kg	*2850	*2850									
		6.0 m	kg	*2450	*2450		*3750	3200						
		4.5 m	kg	*2350	*2350		*5150	3150	*6150	4900				
		3.0 m	kg	*2350	2100	*2950	2150	*5550	3050	*7250	4600			
		1.5 m	kg	*2500	2050	*3800	2100	*5850	2900	*8000	4300			
		0.0 m	kg	*2800	2100			*5800	2800	*8000	4150			
	2500 mm	-1.5 m	kg	*3350	2300			*5200	2800	*7050	4100	*8250	7650	
		-3.0 m	kg	*3450	2850					*5350	4150	*6800	*6800	
		-4.5 m	kg											
		7.5 m	kg	*2300	*2300									
		6.0 m	kg	*2050	*2050		*3650	3250						
		4.5 m	kg	*2000	*2000	*2250	2250	*4600	3150					
3000 mm	3.0 m	kg	*2000	1950	*3650	2200	*5350	3050	*6900	4650				
	1.5 m	kg	*2100	1900	*4450	2100	*5750	2900	*7800	4350				
	0.0 m	kg	*2300	1950	*4350	2050	*5850	2800	*8000	4150	*4700	*4700		
	-1.5 m	kg	*2750	2100			*5400	2750	*7350	4050	*7700	7550	*4600	*4600
	-3.0 m	kg	*3500	2550			*4100	2750	*5850	4100	*7800	7700		
	-4.5 m	kg												
 <p>Rear outrigger</p>	2100 mm	7.5 m	kg	*2850	*2850									
		6.0 m	kg	*2450	*2450		*3750	*3750						
		4.5 m	kg	*2350	*2350		*5150	3950	*6150	*6150				
		3.0 m	kg	*2350	*2350	*2950	2700	*5550	3800	*7250	5850			
		1.5 m	kg	*2500	*2500	*3800	2700	*5850	3700	*8000	5550			
		0.0 m	kg	*2800	2650			*5800	3600	*8000	5400			
	2500 mm	-1.5 m	kg	*3350	2950			*5200	3550	*7050	5350	*8250	*8250	
		-3.0 m	kg	*3450	*3450					*5350	*5350	*6800	*6800	
		-4.5 m	kg											
		7.5 m	kg	*2300	*2300									
		6.0 m	kg	*2050	*2050		*3650	*3650						
		4.5 m	kg	*2000	*2000	*2250	*2250	*4600	4000					
3000 mm	3.0 m	kg	*2000	*2000	*3650	2750	*5350	3850	*6900	5950				
	1.5 m	kg	*2100	*2100	*4450	2700	*5750	3700	*7800	5550				
	0.0 m	kg	*2300	*2300	*4350	2600	*5850	3600	*8000	5400	*4700	*4700		
	-1.5 m	kg	*2750	2700			*5400	3500	*7350	5300	*7700	*7700	*4600	*4600
	-3.0 m	kg	*3500	3250			*4100	3550	*5850	5300	*7800	*7800		
	-4.5 m	kg												

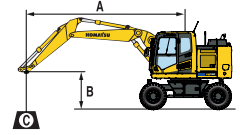

- A – Reach from swing center
- B – Bucket hook height
- C – Lifting capacities, including bucket linkage (136 kg) and bucket cylinder (96 kg)
- ⊗ – Rating over front
- ⊗ – Rating over side
- ⊗ – Rating at maximum reach

When removing linkage or cylinder, lifting capacities can be increased by their respective weights.

\* Load is limited by hydraulic capacity rather than tipping. Ratings are based on ISO standard 10567. Rated loads do not exceed 87% of hydraulic lift capacity or 75% of tipping load.

Arm length	A	B	7.5 m		6.0 m		4.5 m		3.0 m		1.5 m		
			Rating at maximum reach	Rating over side	Rating at maximum reach	Rating over side	Rating at maximum reach	Rating over side	Rating at maximum reach	Rating over side	Rating at maximum reach	Rating over side	
 <p>Outrigger + blade</p>	2100 mm	7.5 m	kg	*2850	*2850								
		6.0 m	kg	*2450	*2450		*3750	*3750					
		4.5 m	kg	*2350	*2350		*5150	4900	*6150	*6150			
		3.0 m	kg	*2350	*2350	*2950	*2950	*5550	4800	*7250	*7250		
		1.5 m	kg	*2500	*2500	*3800	3350	*5850	4650	*8000	7100		
		0.0 m	kg	*2800	*2800			*5800	4500	*8000	6900		
		- 1.5 m	kg	*3350	*3350			*5200	4500	*7050	6900	*8250	*8250
		- 3.0 m	kg	*3450	*3450					*5350	*5350	*6800	*6800
		- 4.5 m	kg										
		7.5 m	kg	*2300	*2300								
		6.0 m	kg	*2050	*2050			*3650	*3650				
		4.5 m	kg	*2000	*2000	*2250	*2250	*4600	*4600				
	3.0 m	kg	*2000	*2000	*3650	3400	*5350	4800	*6900	*6900			
	1.5 m	kg	*2100	*2100	*4450	3350	*5750	4650	*7800	7150			
	0.0 m	kg	*2300	*2300	*4350	3300	*5850	4500	*8000	6900	*4700	*4700	
	- 1.5 m	kg	*2750	*2750			*5400	4450	*7350	6850	*7700	*7700	
	- 3.0 m	kg	*3500	*3500			*4100	*4100	*5850	*5850	*7800	*7800	
	- 4.5 m	kg											
	7.5 m	kg	*1900	*1900			*2400	*2400					
	6.0 m	kg	*1700	*1700			*3300	*3300					
	4.5 m	kg	*1650	*1650	*2950	*2950	*3800	*3800					
	3.0 m	kg	*1650	*1650	*3700	3400	*5000	4800	*6350	*6350	*9450	*9450	
	1.5 m	kg	*1700	*1700	*4450	3300	*5550	4600	*7450	7150			
	0.0 m	kg	*1900	*1900	*4450	3250	*5750	4450	*7900	6850	*5000	*5000	
	- 1.5 m	kg	*2200	*2200	*4050	3200	*5500	4350	*7550	6750	*7000	*7000	
	- 3.0 m	kg	*2800	*2800			*4600	4350	*6350	*6350	*8850	*8850	
	- 4.5 m	kg	*2600	*2600					*4000	*4000	*5450	*5450	

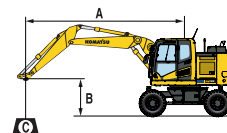

A - Reach from swing center

B - Bucket hook height

C - Lifting capacities, including bucket linkage (136 kg) and bucket cylinder (96 kg)

 - Rating over front

 - Rating over side



 - Rating at maximum reach

When removing linkage or cylinder, lifting capacities can be increased by their respective weights.



\* Load is limited by hydraulic capacity rather than tipping. Ratings are based on ISO standard 10567. Rated loads do not exceed 87% of hydraulic lift capacity or 75% of tipping load.

Arm length	A	B	7.5 m		6.0 m		4.5 m		3.0 m		1.5 m		
			Rating at maximum reach	Rating over side	Rating at maximum reach	Rating over side	Rating at maximum reach	Rating over side	Rating at maximum reach	Rating over side	Rating at maximum reach	Rating over side	
 <p>Outrigger front + rear</p>	2100 mm	7.5 m	kg	*2850	*2850								
		6.0 m	kg	*2450	*2450		*3750	*3750					
		4.5 m	kg	*2350	*2350		*5150	*5150	*6150	*6150			
		3.0 m	kg	*2350	*2350	*2950	*2950	*5550	*5550	*7250	*7250		
		1.5 m	kg	*2500	*2500	*3800	*3800	*5850	5700	*8000	*8000		
		0.0 m	kg	*2800	*2800			*5800	5550	*8000	*8000		
		- 1.5 m	kg	*3350	*3350			*5200	*5200	*7050	*7050	*8250	*8250
		- 3.0 m	kg	*3450	*3450					*5350	*5350	*6800	*6800
		- 4.5 m	kg										
		7.5 m	kg	*2300	*2300								
		6.0 m	kg	*2050	*2050			*3650	*3650				
		4.5 m	kg	*2000	*2000	*2250	*2250	*4600	*4600				
	3.0 m	kg	*2000	*2000	*3650	*3650	*5350	*5350	*6900	*6900			
	1.5 m	kg	*2100	*2100	*4450	4050	*5750	5700	*7800	*7800			
	0.0 m	kg	*2300	*2300	*4350	4050	*5850	5550	*8000	*8000	*4700	*4700	
	- 1.5 m	kg	*2750	*2750			*5400	*5400	*7350	*7350	*7700	*7700	
	- 3.0 m	kg	*3500	*3500			*4100	*4100	*5850	*5850	*7800	*7800	
	- 4.5 m	kg											
	7.5 m	kg	*1900	*1900			*2400	*2400					
	6.0 m	kg	*1700	*1700			*3300	*3300					
	4.5 m	kg	*1650	*1650	*2950	*2950	*3800	*3800					
	3.0 m	kg	*1650	*1650	*3700	*3700	*5000	*5000	*6350	*6350	*9450	*9450	
	1.5 m	kg	*1700	*1700	*4450	4050	*5550	*5550	*7450	*7450			
	0.0 m	kg	*1900	*1900	*4450	3950	*5750	5550	*7900	*7900	*5000	*5000	
	- 1.5 m	kg	*2200	*2200	*4050	3900	*5500	5400	*7550	*7550	*7000	*7000	
	- 3.0 m	kg	*2800	*2800			*4600	*4600	*6350	*6350	*8850	*8850	
	- 4.5 m	kg	*2600	*2600					*4000	*4000	*5450	*5450	

## Lifting capacity / two-piece boom / undercarriage width 2.75 m

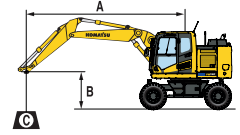
Arm length		A		7.5 m		6.0 m		4.5 m		3.0 m		1.5 m			
		B		Rating over front	Rating over side	Rating over front	Rating over side	Rating over front	Rating over side	Rating over front	Rating over side	Rating over front	Rating over side		
	2100 mm	7.5 m	kg	*3150	*3150			*4150	*4150						
		6.0 m	kg	*2650	2550		3550	2750	*4850	4400					
		4.5 m	kg	*2550	2100		3500	2700	5550	4250	*5700	*5700			
		3.0 m	kg	2400	1850		3400	2600	5200	3950					
		1.5 m	kg	2300	1800	2350	1800	3250	2450	4900	3650				
		0.0 m	kg	2400	1800			3150	2400	4700	3450	*4150	*4150		
		-1.5 m	kg	2650	2000			3150	2350	4650	3450	*8350	6300		
		-3.0 m	kg	3700	2800					4700	3500				
		-4.5 m	kg												
	2500 mm	7.5 m	kg	*2550	*2550				*3950	*3950					
		6.0 m	kg	*2250	*2250		3600	2800	*4050	*4050					
		4.5 m	kg	*2100	1900		3550	2750	*4650	4300					
		3.0 m	kg	*2150	1700	2400	1850	3400	2600	5250	4000	10200	7300		
		1.5 m	kg	2150	1650	2350	1800	3250	2450	4950	3700				
		0.0 m	kg	2200	1650	2300	1750	3150	2350	4700	3450	*4700	*4700		
		-1.5 m	kg	2400	1800			3100	2300	4650	3400	*7800	6150		
		-3.0 m	kg	2950	2250			3150	2350	4650	3450				
		-4.5 m	kg												
	3000 mm	7.5 m	kg	*2100	*2100			*2400	*2400						
		6.0 m	kg	*1850	*1850			*3300	2850						
		4.5 m	kg	*1750	1650	2450	1900	3600	2750	*3550	*3550				
		3.0 m	kg	*1750	1500	2400	1800	3400	2600	5350	4050	*9100	7650		
		1.5 m	kg	*1850	1450	2300	1750	3250	2450	4950	3700				
		0.0 m	kg	1950	1450	2250	1650	3100	2300	4650	3450	*4950	*4950		
		-1.5 m	kg	2100	1600	2250	1650	3000	2250	4500	3300	*7050	6000	*3800	*3800
		-3.0 m	kg	2500	1850			3000	2250	4500	3300	8850	6100		
		-4.5 m	kg												
	2100 mm	7.5 m	kg	*3150	*3150			*4150	*4150						
		6.0 m	kg	*2650	*2650		*3700	3200	*4850	*4850					
		4.5 m	kg	*2550	2400		*5150	3150	*5750	4950	*5700	*5700			
		3.0 m	kg	*2550	2200		*5800	3050	*7400	4650					
		1.5 m	kg	*2650	2100	*3400	2100	*6300	2900	*8600	4350				
		0.0 m	kg	*2950	2150			*6450	2850	*8850	4200	*4150	*4150		
		-1.5 m	kg	*3500	2400			*6050	2800	*8350	4100	*8350	7700		
		-3.0 m	kg	*5400	3300					*6700	4200				
		-4.5 m	kg												
	2500 mm	7.5 m	kg	*2550	*2550				*3950	*3950					
		6.0 m	kg	*2250	*2250		*3700	3300	*4050	*4050					
		4.5 m	kg	*2100	*2100		*4450	3200	*4650	*4650					
		3.0 m	kg	*2150	2000	*3600	2200	*5600	3050	*7000	4700	8850			
		1.5 m	kg	*2250	1950	*4350	2100	*6100	2900	*8250	4350				
		0.0 m	kg	*2450	1950	*4100	2100	*6400	2800	*8850	4150	*4700	*4700		
		-1.5 m	kg	*2900	2150			*6200	2750	*8500	4050	*7800	7650		
		-3.0 m	kg	*4050	2650			*5000	2800	*7250	4100				
		-4.5 m	kg												
	3000 mm	7.5 m	kg	*2100	*2100			*2400	*2400						
		6.0 m	kg	*1850	*1850			*3300	3300						
		4.5 m	kg	*1750	*1750	*2950	2250	*3700	3200	*3550	*3550				
		3.0 m	kg	*1750	*1750	*3650	2150	*4700	3050	*5700	4750	*9100	*9100		
		1.5 m	kg	*1850	1700	*4350	2100	*5850	2900	*7800	4350				
		0.0 m	kg	*2000	1750	4750	2000	*6300	2750	*8600	4100	*4950	*4950		
		-1.5 m	kg	*2300	1900	*3900	1950	*6250	2700	*8600	4000	*7050	*7050	*3800	*3800
		-3.0 m	kg	*2900	2250			*5500	2700	*7700	4000	*10950	7500		
		-4.5 m	kg												
	2100 mm	7.5 m	kg	*3150	*3150			*4150	*4150						
		6.0 m	kg	*2650	*2650		*3700	*3700	*4850	*4850					
		4.5 m	kg	*2550	*2550		*5150	4000	*5750	*5750	*5700	*5700			
		3.0 m	kg	*2550	*2550		*5800	3850	*7400	4950					
		1.5 m	kg	*2650	2650	*3400	2700	*6300	3700	*8600	5600				
		0.0 m	kg	*2950	2700			*6450	3600	*8850	5400	*4150	*4150		
		-1.5 m	kg	*3500	3000			*6050	3600	*8350	5400	*8350	*8350		
		-3.0 m	kg	*5400	4250					*6700	5450				
		-4.5 m	kg												
	2500 mm	7.5 m	kg	*2550	*2550				*3950	*3950					
		6.0 m	kg	*2250	*2250		*3700	*3700	*4050	*4050					
		4.5 m	kg	*2100	*2100		*4450	4000	*4650	*4650					
		3.0 m	kg	*2150	*2150	*3600	2750	*5600	3900	*7000	6000	*10700	*10700		
		1.5 m	kg	*2250	*2250	*4350	2700	*6100	3750	*8250	5650				
		0.0 m	kg	*2450	*2450	*4100	2650	*6400	3600	*8850	5400	*4700	*4700		
		-1.5 m	kg	*2900	2750			*6200	3550	*8500	5350	*7800	*7800		
		-3.0 m	kg	*4050	3400			*5000	3600	*7250	5400				
		-4.5 m	kg												
	3000 mm	7.5 m	kg	*2100	*2100			*2400	*2400						
		6.0 m	kg	*1850	*1850			*3300	*3300						
		4.5 m	kg	*1750	*1750	*2950	2800	*3700	*3700	*3550	*3550				
		3.0 m	kg	*1750	*1750	*3650	2750	*4700	3900	*5700	*5700	*9100	*9100		
		1.5 m	kg	*1850	*1850	*4350	2650	*5850	3700	*7800	5650				
		0.0 m	kg	*2000	*2000	4500	2550	*6300	3550	*8600	5400	*4950	*4950		
		-1.5 m	kg	*2300	*2300	*3900	2550	*6250	3450	*8600	5250	*7050	*7050	*3800	*3800
		-3.0 m	kg	*2900	2850			*5500	3450	*7700	5250	*10950	10350		
		-4.5 m	kg												



- A** – Reach from swing center
- B** – Bucket hook height
- C** – Lifting capacities, including bucket linkage (136 kg) and bucket cylinder (96 kg)
-  – Rating over front
-  – Rating over side
-  – Rating at maximum reach

When removing linkage or cylinder, lifting capacities can be increased by their respective weights.

\* Load is limited by hydraulic capacity rather than tipping. Ratings are based on ISO standard 10567. Rated loads do not exceed 87% of hydraulic lift capacity or 75% of tipping load.

Arm length	A	B	7.5 m		6.0 m		4.5 m		3.0 m		1.5 m		
			Rating over front	Rating over side	Rating over front	Rating over side	Rating over front	Rating over side	Rating over front	Rating over side	Rating over front	Rating over side	
 Outrigger + blade	2100 mm	7.5 m	kg *3150	*3150			*4150	*4150					
		6.0 m	kg *2650	*2650			*3700	*3700	*4850	*4850			
		4.5 m	kg *2550	*2550			*5150	4950	*5750	*5750	*5700	*5700	
		3.0 m	kg *2550	*2550			*5800	4800	*7400	*7400			
		1.5 m	kg *2650	*2650	*3400	3350	*6300	4650	*8600	7200			
		0.0 m	kg *2950	*2950			*6450	4550	*8850	6950	*4150	*4150	
	2500 mm	-1.5 m	kg *3500	*3500			*6050	4500	*8350	6900	*8350	*8350	
		-3.0 m	kg *5400	5400					*6700	*6700			
		-4.5 m	kg										
		7.5 m	kg *2550	*2550					*3950	*3950			
		6.0 m	kg *2250	*2250			*3700	*3700	*4050	*4050			
		4.5 m	kg *2100	*2100			*4450	*4450	*4650	*4650			
3000 mm	3.0 m	kg *2150	*2150	*3600	3450	*5600	4800	*7000	*7000				
	1.5 m	kg *2250	*2250	*4350	3350	*6100	4650	*8250	7200				
	0.0 m	kg *2450	*2450	*4100	3300	*6400	4500	*8850	6950	*4700	*4700		
	-1.5 m	kg *2900	*2900			*6200	4500	*8600	6900	*7800	*7800		
	-3.0 m	kg *4050	*4050			*5000	4500	*7250	6900				
	-4.5 m	kg											

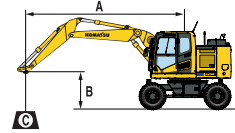

A - Reach from swing center

B - Bucket hook height

C - Lifting capacities, including bucket linkage (136 kg) and bucket cylinder (96 kg)

 - Rating over front

 - Rating over side

 - Rating at maximum reach

 Outrigger front + rear	2100 mm	7.5 m	kg *3150	*3150			*4150	*4150					
		6.0 m	kg *2650	*2650			*3700	*3700	*4850	*4850			
		4.5 m	kg *2550	*2550			*5150	*5150	*5750	*5750	*5700	*5700	
		3.0 m	kg *2550	*2550			*5800	*5800	*7400	*7400			
		1.5 m	kg *2650	*2650	*3400	*3400	*6300	5750	*8600	*8600			
		0.0 m	kg *2950	*2950			*6450	5650	*8850	8850	*4150	*4150	
	2500 mm	-1.5 m	kg *3500	*3500			*6050	5600	*8350	*8350	*8350	*8350	
		-3.0 m	kg *5400	*5400					*6700	*6700			
		-4.5 m	kg										
		7.5 m	kg *2550	*2550					*3950	*3950			
		6.0 m	kg *2250	*2250			*3700	*3700	*4050	*4050			
		4.5 m	kg *2100	*2100			*4450	*4450	*4650	*4650			
3000 mm	3.0 m	kg *2150	*2150	*3600	*3600	*5600	*5600	*7000	*7000	*10700	*10700		
	1.5 m	kg *2250	*2250	*4350	4100	*6100	5750	*8250	*8250				
	0.0 m	kg *2450	*2450	*4100	4050	*6400	5600	*8850	8850	*4700	*4700		
	-1.5 m	kg *2900	*2900			*6200	5550	*8500	*8500	*7800	*7800		
	-3.0 m	kg *4050	*4050			*5000	*5000	*7250	*7250				
	-4.5 m	kg											

When removing linkage or cylinder, lifting capacities can be increased by their respective weights.

\* Load is limited by hydraulic capacity rather than tipping. Ratings are based on ISO standard 10567. Rated loads do not exceed 87% of hydraulic lift capacity or 75% of tipping load.

## Standard and optional equipment

### Engine

Komatsu SAA4D107E-5 turbocharged common rail direct injection diesel engine	●
EU Stage V compliant	●
Suction type cooling fan	●
Automatic engine warm-up system	●
Engine overheat prevention system	●
Fuel control dial	●
Auto-deceleration function	●
Adjustable idle shutdown	●
Engine ignition can be password secured on request	●
Batteries 2 × 12 V / 125 Ah	●
Alternator 24 V / 85 A	●
Starter motor 24 V / 4.5 kW	●

### Hydraulic system

Electronic closed-centre load sensing (E-CLSS) hydraulic system (HydraMind)	●
Pump and engine mutual control (PEMC) system	●
6-working mode selection system; Power, Lifting/Fine Operation, Breaker, Economy, Attachment Power and Attachment Economy	●
PowerMax function	●
Adjustable PPC wrist control levers for arm, boom, bucket and swing, with sliding proportional control for attachments and 5 auxiliary buttons, with FNR switch	●
Additional hydraulic circuit (HCU-B)	●
Additional hydraulic circuit (HCU-C)	○
Clamshell bucket activation	○
Komatsu Integrated Attachment Control (KIAC)	○
Boom suspension system (ECSS)	○
Prepared for hydraulic quick-coupler	○
Drainage line	○

### Undercarriage

Parallel blade (front and/or rear) with cylinder protection	○
2 or 4 outriggers with cylinder protection, individually adjustable	○
Limited-slip differential (LSD)	○
Twin tyres 10.00-20 16 PR	○
Twin tyres (solid tyres) 10.00-20	○
Twin tyres 315/70 R22.5	○
Single tyres 445/70 R19.5	○
Single tyres 710/40 22.5	○
Trailer hitches	○
Fenders	○

### Cabin

SpaceCab™, ROPS, Highly pressurised and tightly sealed hyper viscous mounted cab with tinted safety glass windows, large roof window with sun shade, pull-up type front window with locking device, removable lower window, front window wiper with intermittent feature, sun roller blind, cigarette lighter, luggage shelf, floor mat	●
Heated air suspension seat with lumbar support, arm rests and retractable seat belt	●
Automatic climate control system	●
12/24 Volt power supplies	●
Beverage holder and magazine rack	●
Hot and cool box	●
Adjustable steering column	●
Premium comfort seat	○
DAB+ radio with Bluetooth®, USB, AUX and hands-free kit	○
Heated, adjustable, suspended seat	○
Lower wiper	○
Rain visor (not with OPG)	○
Joystick steering system	○

### Safety equipment

KomVision surround view system	●
Electric horn	●
Overload warning device	●
Lockable fuel cap and covers	●
Audible travel alarm	●
Large handrails, rear-view mirrors	●
Battery main switch	●
Boom safety valves	●
Arm safety valve	●
Adjust cylinder safety valve	●
Emergency engine stop switch	●
OPG Level II front guard (FOPS)	○
OPG Level II top guard (FOPS)	○
Audible travel alarm (white noise version)	○

### Lighting system

Standard halogen working lights package	●
LED working lights package	○
Advanced LED working lights package	○
Beacon	○

**Service and maintenance**

Automatic fuel line de-aeration	●
Double element type air cleaner with dust indicator and auto dust evacuator	●
Komtrax – Komatsu wireless monitoring system (4G)	●
Multifunction video compatible colour monitor with Equipment Management and Monitoring System (EMMS) and efficiency guidance	●
Toolkit	●
Komatsu Care – a maintenance program for Komatsu customers	●
Remote greasing bar	●
Automatic greasing system	○

**Drives and brakes**

Fully automatic 3-speed transmission driving through front and rear planetary axles	●
Oscillating front axle (8°) with automatic and manual cylinder locking	●
Cruise control	●
2.55 m wide undercarriage	●
2.75 m wide undercarriage	○
20, 25 or 35 km/h speed limitation	○
Transmission guard	○
Automatic digging brake	○

**Work equipment**

Mono boom	○
Two-piece boom	○
Boom floating	○
2100 mm; 2500 mm; 3000 mm arms	○
Komatsu breakers	○
Komatsu buckets	○

**Other equipment**

Standard counterweight	●
Electric refuelling pump with automatic shut-off function	●
Single chassis tool box	●
Additional chassis tool box	○
Clamshell grip bar	○
Biodegradable oil for hydraulic system	○
Customised paint	○
License plate holder	○

Further equipment on request

- standard equipment
- optional equipment

This specification sheet may contain attachments and optional equipment that are not available in your area. Please consult your local Komatsu distributor for those items you may require. Materials and specifications are subject to change without notice.

---

Your Komatsu partner:

**KOMATSU**

[komatsu.eu](https://www.komatsu.eu)

